

The power behind competitiveness

Delta UPS - Modulon Family

DPH Series, Three Phase
200-600 kVA

User Manual

SAVE THIS MANUAL

This manual contains important instructions and warnings that you should follow during the installation, operation, storage and maintenance of this product. Failure to heed these instructions and warnings will void the warranty.

Copyright © 2021 by Delta Electronics Inc. All Rights Reserved. All rights of this User Manual ("Manual"), including but not limited to the contents, information, and figures are solely owned and reserved by Delta Electronics Inc. ("Delta"). The Manual can only be applied to the operation or the use of this product. Any disposition, duplication, dissemination, reproduction, modification, translation, extraction, or usage of this Manual in whole or in part is prohibited without the prior written permission of Delta. Given that Delta will continuously improve and develop the product, changes may be made to the information in this Manual at any time without obligation to notify any person of such revision or changes. Delta will make all possible efforts to secure the accuracy and the integrity of this Manual. Delta disclaims any kinds or forms of warranty, guarantee, or undertaking, either expressly or implicitly, including but not limited to the completeness, faultlessness, accuracy, non-infringement, merchantability or fitness for a particular purpose of the Manual.

Table of Contents

1.	Important Safety Instructions	1-1
1.1	Installation Warnings	1-2
1.2	Connection Warnings	1-2
1.3	Usage Warnings	1-3
1.4	Storage Warnings	1-5
1.5	Standard Compliance	1-5
2.	Introduction	2-1
2.1	General Overview	2-2
2.2	Package Inspection	2-2
2.3	Functions & Features	2-4
2.4	Exterior & Dimensions	2-5
2.5	Front View	2-6
2.6	Internal View	2-7
2.7	Rear View	2-10
2.8	Tri-color LED Indicator & Buzzer	2-11
3.	Operation Modes	3-1
3.1	Single Input	3-2
3.1.1	On-Line Mode_ Single Input_ Single Unit	3-2
3.1.2	Battery Mode_ Single Input_ Single Unit	3-3
3.1.3	Bypass Mode_ Single Input_ Single Unit	3-3
3.1.4	Manual Bypass Mode_ Single Input_ Single Unit	3-4
3.1.5	ECO Mode_ Single Input_ Single Unit	3-5
3.1.6	Frequency Conversion Mode_ Single Input_ Single Unit	3-6
3.1.7	Green Mode_ Single Input_ Single Unit	3-6
3.1.8	Energy Recycle Mode_ Single Input_ Single Unit	3-7
3.1.9	On-Line Mode_ Single Input_ Parallel Units	3-8
3.1.10	Battery Mode_ Single Input_ Parallel Units	3-9
3.1.11	Bypass Mode_ Single Input_ Parallel Units	3-10
3.1.12	Manual Bypass Mode_ Single Input_ Parallel Units	3-11
3.1.13	ECO Mode_ Single Input_ Parallel Units	3-13
3.1.14	Green Mode_ Single Input_ Parallel Units	3-14
3.2	Dual Input	3-15
3.2.1	On-Line Mode_ Dual Input_ Single Unit	3-15
3.2.2	Battery Mode_ Dual Input_ Single Unit	3-16
3.2.3	Bypass Mode_ Dual Input_ Single Unit	3-16

3.2.4	Manual Bypass Mode_ Dual Input_ Single Unit -----	3-17
3.2.5	ECO Mode_ Dual Input_ Single Unit -----	3-18
3.2.6	Frequency Conversion Mode_ Dual Input_ Single Unit -----	3-19
3.2.7	Green Mode_ Dual Input_ Single Unit -----	3-20
3.2.8	On-Line Mode_ Dual Input_ Parallel Units -----	3-20
3.2.9	Battery Mode_ Dual Input_ Parallel Units -----	3-22
3.2.10	Bypass Mode_ Dual Input_ Parallel Units -----	3-23
3.2.11	Manual Bypass Mode_ Dual Input_ Parallel Units -----	3-24
3.2.12	ECO Mode_ Dual Input_ Parallel Units -----	3-26
3.2.13	Green Mode_ Dual Input_ Parallel Units -----	3-27
3.3	Hot Standby Redundancy (Only for Dual Input & At Least Two UPSs) -----	3-28
3.4	Common Battery (Only for Parallel UPSs Connecting to the Same External Battery Cabinet(s)) -----	3-29

4. Communication Interfaces ----- 4-1

4.1	Communication Interfaces (I): on the Front of the UPS with Two Front Doors Open -----	4-2
4.1.1	Display Port -----	4-4
4.1.2	REPO Dry Contacts -----	4-4
4.1.3	External Battery Temperature Detection -----	4-5
4.1.4	External Switch/ Breaker Status Dry Contacts -----	4-5
4.1.5	Output Dry Contacts -----	4-7
4.1.6	Input Dry Contacts -----	4-9
4.1.7	Parallel Communication Cards -----	4-10
4.1.8	Parallel Ports -----	4-11
4.1.9	SMART Slot -----	4-11
4.1.10	USB Port & RS-232 Port -----	4-12
4.1.11	Auxiliary Power Cards -----	4-13
4.1.12	Battery Start Buttons -----	4-13
4.2	Communication Interfaces (II): at the Rear of the Touch Panel -----	4-14

5. Installation and Wiring ----- 5-1

5.1	Before Installation and Wiring -----	5-2
5.2	Installation Environment -----	5-2
5.3	UPS Transportation -----	5-4
5.4	UPS Installation -----	5-4
5.5	Wiring -----	5-6
5.5.1	Pre-wiring Warnings -----	5-6
5.5.2	Single Input to Dual Input Modification -----	5-9
5.5.3	Single Unit Wiring -----	5-11

5.5.4	Parallel Units Wiring -----	5-19
5.6	External Battery Cabinet Connection Warnings-----	5-24
5.7	STS Module -----	5-30
5.7.1	STS Module Installation-----	5-31
5.7.2	STS Module Removal -----	5-33
5.7.3	STS Module's LED Indicator-----	5-36
5.8	Power Module (Optional) -----	5-36
5.8.1	Power Module Installation -----	5-37
5.8.2	Power Module Removal -----	5-40
5.8.3	Power Module's LED Indicator -----	5-42
6.	UPS Operation-----	6-1
6.1	Pre Start-up & Pre Turn-off Warnings for Single Unit and Parallel Units -----	6-2
6.2	Start-up Procedures -----	6-4
6.2.1	On-Line Mode Start-up Procedures-----	6-4
6.2.2	Battery Mode Start-up Procedures-----	6-8
6.2.3	Bypass Mode Start-up Procedures -----	6-10
6.2.4	Manual Bypass Mode Start-up Procedures-----	6-13
6.2.5	ECO Mode Start-up Procedures-----	6-18
6.2.6	Frequency Conversion Mode Start-up Procedures -----	6-22
6.2.7	Green Mode Start-up Procedures-----	6-25
6.2.8	Energy Recycle Mode Start-up Procedures -----	6-29
6.3	Turn-off Procedures -----	6-32
6.3.1	On-Line Mode Turn-off Procedures-----	6-32
6.3.2	Battery Mode Turn-off Procedures -----	6-34
6.3.3	Bypass Mode Turn-off Procedures-----	6-36
6.3.4	Manual Bypass Mode Turn-off Procedures -----	6-37
6.3.5	ECO Mode Turn-off Procedures -----	6-37
6.3.6	Frequency Conversion Mode Turn-off Procedures -----	6-40
6.3.7	Green Mode Turn-off Procedures -----	6-43
6.3.8	Energy Recycle Mode Turn-off Procedures-----	6-46
7.	LCD Display & Settings -----	7-1
7.1	LCD Display Hierarchy -----	7-2
7.2	How to Turn on the LCD -----	7-3
7.3	ON/ OFF Button -----	7-5
7.4	Introduction of Touch Panel and Function Keys-----	7-7
7.5	Password Entry-----	7-13
7.6	Main Screen-----	7-13

7.7	Main Menu-----	7-17
7.8	Power Flow, Summary, System Status & EMS-----	7-19
7.9	Check System Readings -----	7-21
7.9.1	Main Input -----	7-21
7.9.1.1	Check Kilowatt-Hour-----	7-22
7.9.2	Bypass Input -----	7-23
7.9.3	Inverter Output -----	7-24
7.9.4	Power Module Summary -----	7-24
7.9.5	UPS Output -----	7-25
7.9.6	Battery Status -----	7-25
7.9.7	EMS-----	7-27
7.9.7.1	Connecting the optional EMS 1000 (EnviroProbe)-----	7-30
7.10	UPS Settings-----	7-30
7.10.1	Bypass Setting -----	7-30
7.10.2	Mode Setting-----	7-31
7.10.3	Output Setting -----	7-32
7.10.4	Battery & Charging Setting-----	7-33
7.10.5	Parallel Setting -----	7-37
7.10.6	Dry Contact Setting -----	7-38
7.10.7	General Setting -----	7-40
7.10.8	IP Setting -----	7-43
7.10.9	Control-----	7-44
7.10.10	EMS Setting-----	7-45
7.11	System Maintenance-----	7-47
7.11.1	Alarm Warning-----	7-47
7.11.2	Historical Event -----	7-48
7.11.3	Statistics -----	7-50
7.11.4	Test-----	7-50
7.11.5	Clear -----	7-51
7.11.6	Advanced Diagnosis-----	7-52
7.11.7	Version & S/N-----	7-53
8.	Optional Accessories -----	8-1
9.	Maintenance-----	9-1
Appendix 1	Technical Specifications-----	A1-1
Appendix 2	Warranty -----	A2-1

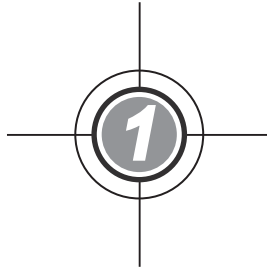

Important Safety Instructions

1.1 Installation Warnings

1.2 Connection Warnings

1.3 Usage Warnings

1.4 Storage Warnings

1.5 Standard Compliance

1.1 Installation Warnings

- This is a three-phase four-wire on-line uninterruptible power supply (hereafter referred to as 'UPS'). It can be used for commercial and industrial applications.
- Install the UPS in a well-ventilated indoor area, away from excess moisture, heat, dust, flammable gas or explosives. To avoid fire accidents and electric shock, the indoor area must be free of conductive contaminants. For the temperature and humidity specifications, please refer to **Appendix 1: Technical Specifications**.
- Leave adequate space around all sides of the UPS for proper ventilation and maintenance. Please refer to **5.2 Installation Environment**.
- Only authorized Delta engineers or service personnel can perform installation and maintenance. If you want to install the UPS by yourself, please install it under the supervision of authorized Delta engineers or service personnel.
- Follow the IEC 60364-4-42 standard to install the UPS.

1.2 Connection Warnings

- Before applying electrical power to the UPS, make sure the UPS is grounded to avoid a possible risk of current leakage.
- You can parallel a maximum of eight UPS units.
- The UPS must be connected with an external battery cabinet (user-supplied, handled and configured by Delta service personnel). Please refer to **5.6 External Battery Cabinet Connection Warnings** for relevant information.
- The installation of protective devices is highly recommended when the UPS is connected to power sources and critical loads.
- The protective devices connected to the UPS must be installed near the UPS and easily accessible for operation.
- Protective Devices:
 1. For single input, you must install (1) a protective device between the main AC source and the UPS and (2) a protective device between the connected critical loads and the UPS.
 2. For dual input, you must install (1) a protective device between the main AC source and the UPS, (2) a protective device between the bypass source and the UPS and (3) a protective device between the connected critical loads and the UPS.
 3. For grounding information, please refer to **Figure 5-13** and **Figure 5-15**.

4. Each protective device could be a breaker or a fuse. For the protective device's rating current, please refer to the table below.

200kVA	300kVA	400kVA	500kVA	600kVA
400A	600A	800A	1000A	1250A

5. Each protective device should have the functions of over current protection, short circuit protection, insulating protection and shunt trip feature. Please refer to the table below for the UPS rated short-time withstand current (I_{cw}).

200kVA	300kVA	400kVA	500kVA	600kVA
10kA	10kA	12.12kA	15.15kA	18.18kA

6. When selecting the protective devices, please take each power cable's current capacity and the system's overload capacity (please refer to **Appendix 1: Technical Specifications**) into consideration. Besides, the short-circuit capacity of the upstream protective devices must be equal to or larger than the capacity of the UPS's input protective devices.
7. Due to abnormalities in the UPS, the fault current may reach 20kA. At the time, the UPS's internal semi-conductor fuses will take 8 ~ 10 ms to open. Thus, the reaction time of the upstream*¹ protective devices must be more than 10 ms so that the fuses would have sufficient time to interrupt the fault current, and the UPS's bypass will be able to keep supplying power to the loads.



NOTE:

*¹ For dual input application, this refers to the bypass upstream.

8. If the UPS is supplied by a power source whose neutral is grounded, each protective device must be a 3-pole type. If the UPS is supplied by a power source whose neutral is not grounded, each protective device must be a 4-pole type.
9. The recommended electrical rating of the input, output and backfeed protective devices are as follows. Application of the protective devices shall be in accordance with local installation codes.

200kVA	300kVA	400kVA	500kVA	600kVA
690V/ 400A	690V/ 600A	690V/ 800A	690V/ 1000A	690V/ 1250A

1.3 Usage Warnings

- Before installation, wiring and working on the UPS's internal circuits, please completely cut off all power supplying to the UPS, including the input power and battery power.

- The UPS is specifically designed for information technology equipment and used to power computers, servers, and associated peripheral devices. If you want to connect any capacitive loads or non-linear loads (that have serious surge current) to the UPS, it needs to be de-rated according to on-site applications. For such special applications, please contact Delta service personnel for the accurate UPS sizing. The UPS is not suitable for connecting with any asymmetrical loads. For the load suitability, please contact Delta customer service before purchasing.
- The external slits and openings in the UPS are provided for ventilation. To ensure reliable operation of the UPS and to protect the UPS from overheating, these slits and openings must not be blocked or covered. Do not insert any object into the slits and openings that may hinder ventilation.
- Before applying electrical power to the UPS, you must allow the UPS to adjust to room temperature (20°C ~ 25°C (68°F ~ 77°F)) for at least one hour and ensure that there is no moisture condensing inside the unit.
- Do not put beverages on the UPS, external battery cabinet(s) or any other accessory associated with the UPS.
- Do not open or remove the covers or panels of the UPS to avoid high voltage electric shock. Only authorized Delta engineers or service personnel can do so for installation or maintenance. If you want to open or remove the covers or panels, do it only under the supervision of authorized Delta engineers or service personnel.
- It is not recommended to connect the UPS to any regenerative loads. For the load suitability, please contact Delta customer service before purchasing.
- The risk of dangerous high voltage is possible when batteries are still connected to the UPS even though the UPS is disconnected from the power sources. Before maintenance, turn off each external battery cabinet's circuit breaker to completely cut off the battery power from the UPS.
- Do not dispose of the battery or batteries in a fire. The batteries may explode.
- Do not open or damage the battery or batteries. The released electrolyte is harmful to the skin and eyes and may be toxic.
- The UPS is electronic equipment that runs 24 hours continuously. To ensure its normal lifetime, regular maintenance of the UPS and batteries is of vital importance and necessary.
- Some components like batteries, power capacitors, and fans will become worn-out due to long-term usage, and this will increase the risk of UPS failure. To replace and maintain the components, please contact Delta service personnel.
- A battery can present a risk of electrical shock and high short-circuit current. Contact with any part of a grounded battery can result in electrical shock. The following precautions should be observed when working on batteries:

1. Remove watches, rings, or other metal objects.
 2. Use tools with insulated handles.
 3. Wear rubber gloves and boots.
 4. Do not lay tools or metal parts on top of the batteries.
 5. Disconnect charging source and loads prior to installing or maintaining the batteries.
 6. Remove battery grounds during installation and maintenance to reduce likelihood of shock. Remove the connection from ground if any part of the battery is determined to be grounded. Please note that the battery grounds mean any battery pole (+/ -) connecting to the ground.
- You must contact Delta customer service if any of the following events occurs:
 1. Any liquid is poured or splashed on the UPS.
 2. The UPS is deformed.
 3. Any conductive powders or metals enter into the UPS.
 4. The UPS does not run normally after carefully following the instructions in this **User Manual**.

1.4 Storage Warnings

- Use the original packing material to pack the UPS to prevent any possible damage from rodents.
- If the UPS needs to be stored prior to installation, it should be placed in a dry indoor area. The allowable storage temperature is below 70°C and relative humidity is below 95%.

1.5 Standard Compliance

- EN 62040-1
- EN 61000-6-4
- EN 62040-2 Category C3
- EN 61000-4-2
- EN 61000-4-3
- EN 61000-4-4
- EN 61000-4-5
- EN 61000-4-6
- EN 61000-4-8
- EN 61000-2-2
- YD/ T 2165-2010
- YD 5083-2005
- YD/ T 5096-2016

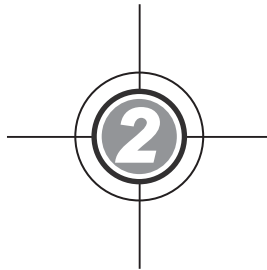

Introduction

2.1 General Overview

2.2 Package Inspection

2.3 Functions & Features

2.4 Exterior & Dimensions

2.5 Front View

2.6 Internal View

2.7 Rear View

2.8 Tri-color LED Indicator
& Buzzer

2.1 General Overview

The DPH series UPS, a three-phase four-wire online uninterruptible power supply (hereafter referred to as 'UPS'), is a dedicated design for data centers, factory facilities and large scale power systems. The unit not only adopts advanced IGBT technology to provide high quality, low noise, pure and uninterruptible output power to the connected loads, but also applies the latest design of DSP digital control technology and highest quality components.

2.2 Package Inspection

- **External**

During UPS transportation, some unpredictable situations might occur. It is recommended that you inspect the UPS exterior packaging. If you notice any damage, please immediately contact the dealer from whom you purchased the unit.

- **Internal**

1. Check the rating label attached to the UPS and make sure the device No. and capacity match what you ordered.
2. Examine if any parts are loose or damaged.
3. The UPS package contains the following items. Please check if any items are missing.

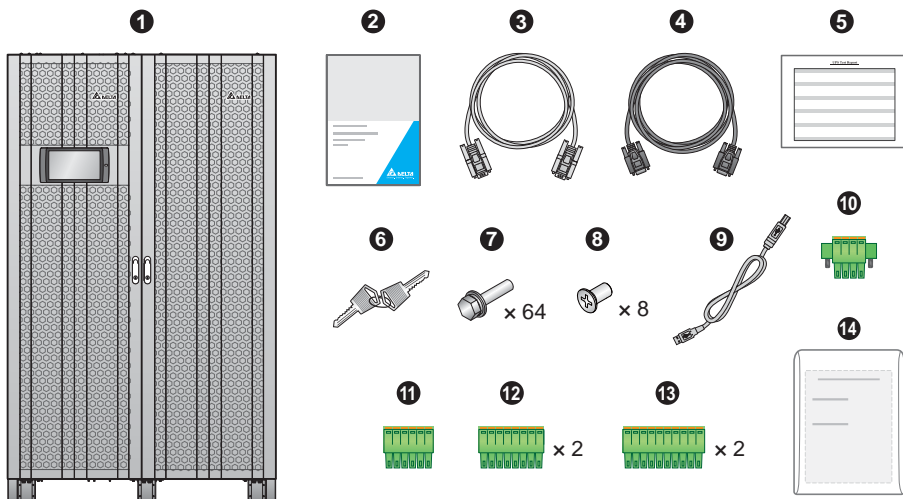

No.	Item	Q'ty
1	UPS (three pieces of 50ppi dust filters have been installed on the inner side of the UPS's two front doors before shipment)	1 PC

No.	Item	Q'ty
②	User Manual	1 PC
③	RS-232 Cable	1 PC
④	Parallel Cable	1 PC
⑤	Test Report	1 PC
⑥	Key	2 PCS
⑦	M12 Screw (used for input/ output/ battery/ grounding wiring)	64 PCS
⑧	M4 Screw (used to fix parallel fasteners)	8 PCS
⑨	USB Cable	1 PC
⑩	4-Pin Dry Contact Terminal Block (used for REPO dry contacts; please refer to Figure 4-3)	1 PC
⑪	6-Pin Dry Contact Terminal Block (used for MODBUS and BMS ports located at the rear of the touch panel; please refer to Figure 4-17)	1 PC
⑫	8-Pin Dry Contact Terminal Block (used for (1) external battery temperature detection and (2) external switch/ breaker status dry contacts; please refer to Figure 4-3)	2 PCS
⑬	10-Pin Dry Contact Terminal Block (used for input/ output dry contacts; please refer to Figure 4-3)	2 PCS
⑭	Protection Dustproof Cover* ¹  NOTE: * ¹ The protection dustproof cover is a standard accessory provided in the UPS's carton. For how to install the protection dustproof cover, please refer to the Quick Guide placed in the dustproof cover's package.	1 Set

4. If there is any damage or anything missing, please immediately contact the dealer from whom you purchased the unit.
5. If the UPS needs to be returned, carefully repack the UPS and all of the accessories using the original packing material that came with the unit.

2.3 Functions & Features

- Hot swappable STS module, communication interfaces and power modules (optional) realize on-line maintenance, reduce the MTTR (Mean Time to Repair) and expand system capacity flexibly (200 ~ 600kVA).
- Input power factor > 0.99 and input THDi ≤ 3% save on installation cost and diminish power contamination.
- Output power factor= 1.
- Efficiency > 96.5% saves on operation cost.
- Automatic input frequency detection enables operation at 40Hz ~ 70Hz.
- Automatic restart
 1. The UPS will restart in normal mode automatically right after the AC line resumes following a low battery shutdown.
 2. The UPS returns automatically to normal mode from bypass mode after an overload condition is cleared.
- Automatically detects whether bypass voltage is out of rating voltage (default: voltage ±15% & frequency ±3Hz). If yes, the UPS will stop supplying power to the critical loads to protect your electronic equipment.
- Supports ECO mode: when input voltage and frequency are within the range of rating voltage ±10% and rating frequency ±5Hz, the UPS will transfer to bypass mode; otherwise, the UPS will transfer to normal mode to reach higher efficiency.
- Both auxiliary power and control circuit adopt redundancy design, which doubly enhances UPS reliability.
- Applicable to top and bottom wiring.
- Generator compatible.
- Surge protection and EMI filter functions.
- Remote emergency power off.
- Single input and dual input functions.
- Supports external switch/ breaker status detection.
- Wide AC input voltage range 176 Vac ~ 276 Vac (full load)) reduces frequent transfer from normal mode to battery mode to save battery consumption and prolong battery life.
- Battery start-up function even when there is no AC input.
- AC start-up function even when the UPS is not connected to the batteries.



WARNING:

Please note that when the UPS is not connected to the batteries, it will not protect your equipment if the utility power is lost.

- Connects to eight external battery cabinets at maximum to extend the backup time.
- Provides setting options such as battery test (schedulable) and battery replacement alarm.
- Battery temperature monitoring and compensation.
- Optional battery management system (BMS) allows measurement of every battery's voltage.
- Smart battery charger design allows auto-charging or manual charging to shorten the charging time.
- Provides communication interfaces and a smart slot. Please refer to **4. Communication Interfaces**.
- Built-in memory stores a maximum of 10,000 event logs.
- Fan speed auto adjustment prolongs fan life and reduces noise when the critical loads decrease. Moreover, fan failure detection circuit is established.
- State-of-the-art microprocessor technology performs self-detection and monitors fan speed in real time, which provides complete and detailed operating status of the UPS.

2.4 Exterior & Dimensions

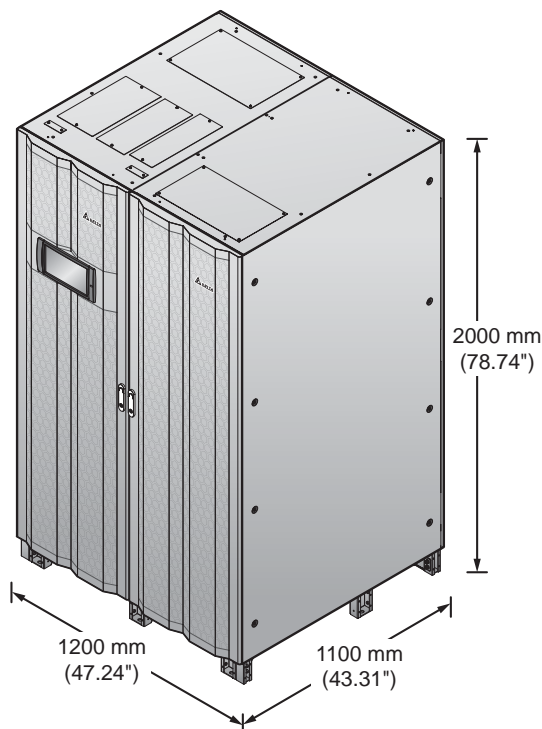

(Figure 2-1: Exterior & Dimensions)

2.5 Front View

On the front of the UPS, there are a 10" color touch panel, a tri-color LED indicator, two door handles and eight stands. Please see **Figure 2-2**.

1. For information about the 10" color touch panel, please refer to **7. LCD Display & Settings**.
2. For information about the tri-color LED indicator, please refer to **2.8 Tri-color LED Indicator & Buzzer**.
3. The eight stands at the bottom of the UPS firmly fix and stabilize the UPS on the ground. Please refer to **5.4 UPS Installation** for relevant information.
4. Please refer to **Figure 2-3** for how to open the UPS front doors.

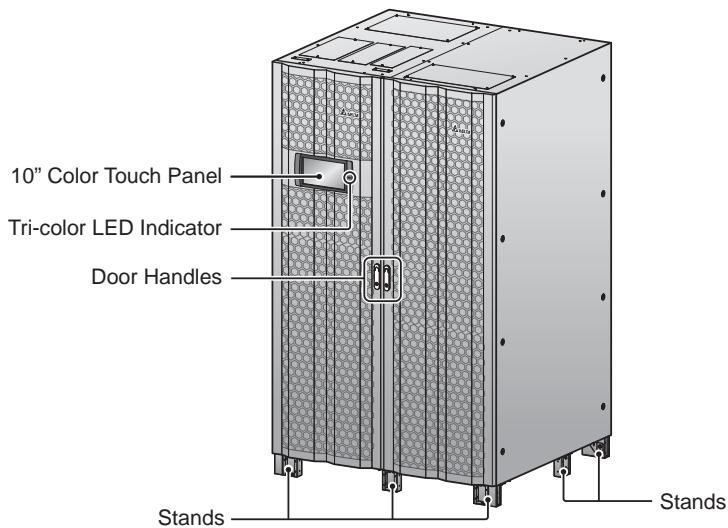

(Figure 2-2: UPS Front View)

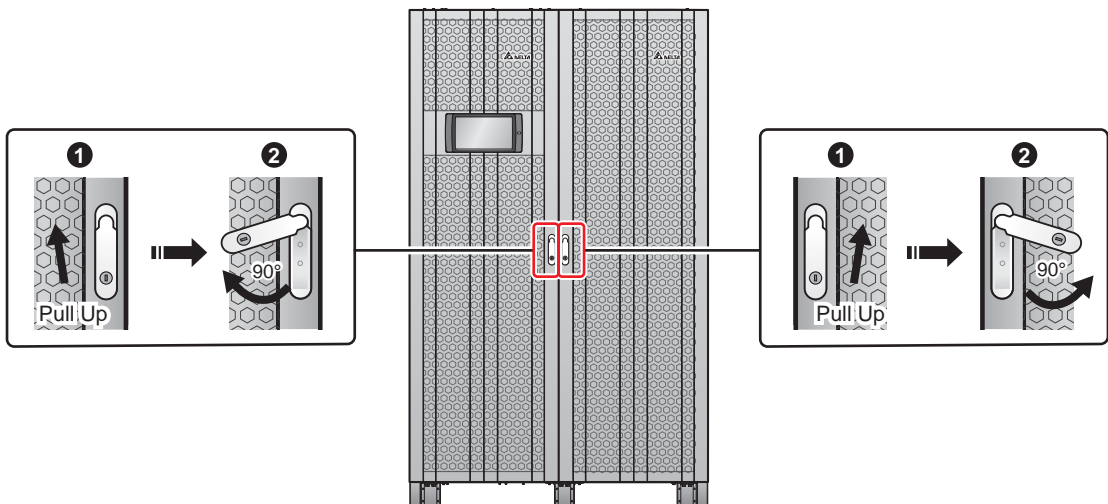

(Figure 2-3: How to Open the UPS Front Doors)

2.6 Internal View



WARNING:

Only authorized Delta engineers or service personnel can perform installation, wiring, panel & cover removal, maintenance and operation. If you want to execute any action mentioned above by yourself, the action must be under the supervision of authorized Delta engineers or service personnel.

After you open the UPS's front doors, you will see the internal mechanisms, including communication interfaces, twelve power module slots (among which, only the bottom two slots have covers), an STS module and four switches (Input/ Bypass/ Manual Bypass/ Output). Please refer to **Figure 2-4**.

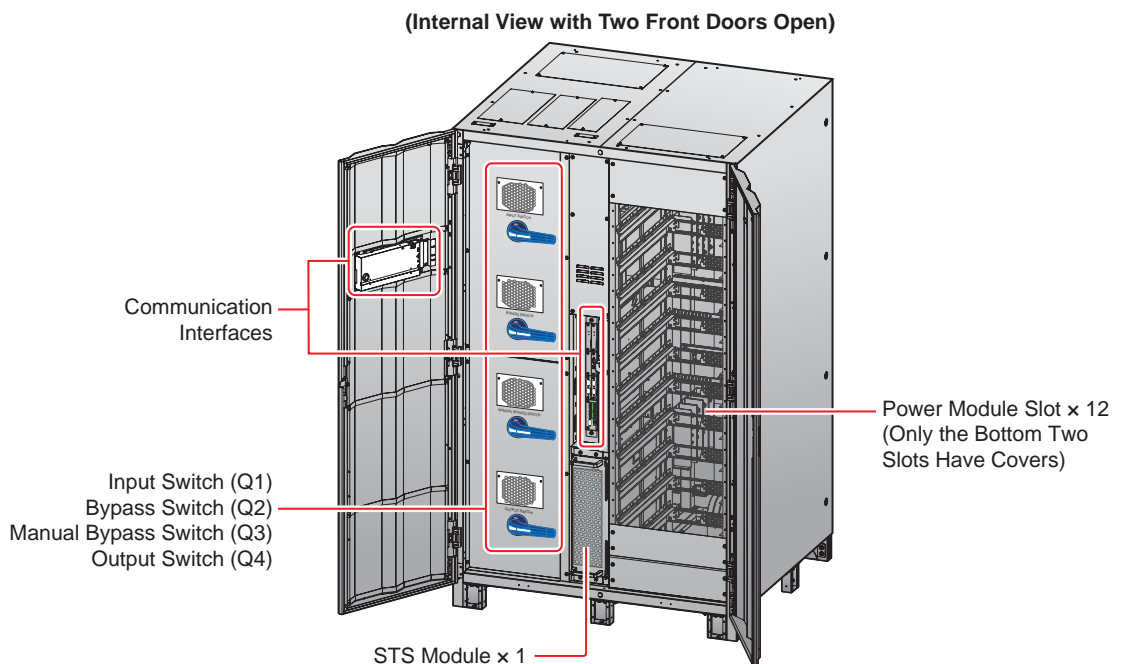

(Figure 2-4: UPS Internal View with Two Front Doors Open)

1. For information about the communication interfaces, please refer to **4. Communication Interfaces**.
2. For how to turn **ON/ OFF** each switch, please refer to **Figure 2-5**.

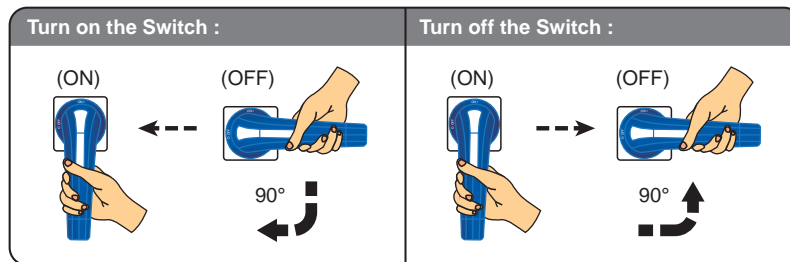

(Figure 2-5: Turn on/ off the Switch)

3. For STS module information, please refer to **5.7 STS Module**.
4. For power module slots, please follow on-site requirements to install the correct number of power modules (optional) into the slots. Please refer to **5.8 Power Module (Optional)** for relevant information.
5. To see the wiring terminals shown in **Figure 2-7 ~ Figure 2-9**, please remove the twelve screws from the two switch panels shown in **Figure 2-6**.

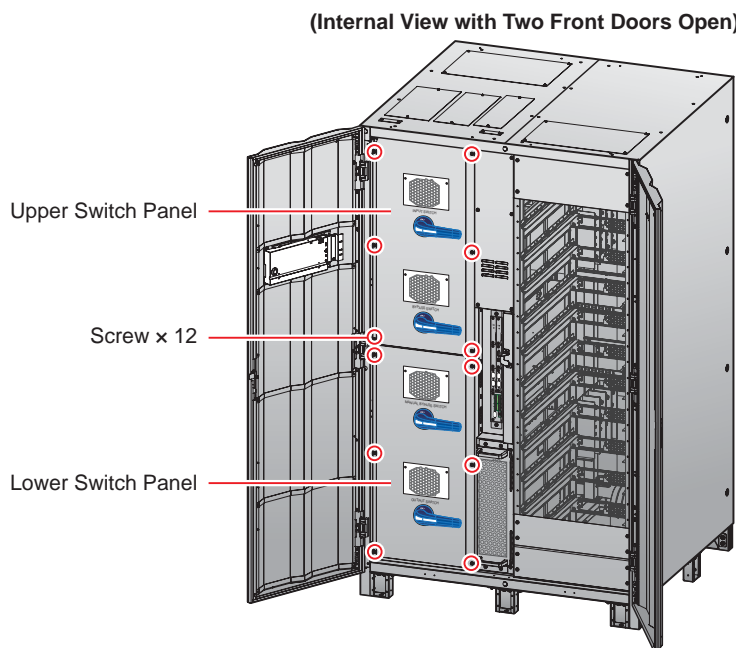

(Figure 2-6: Location of the Switch Panels and Screws)

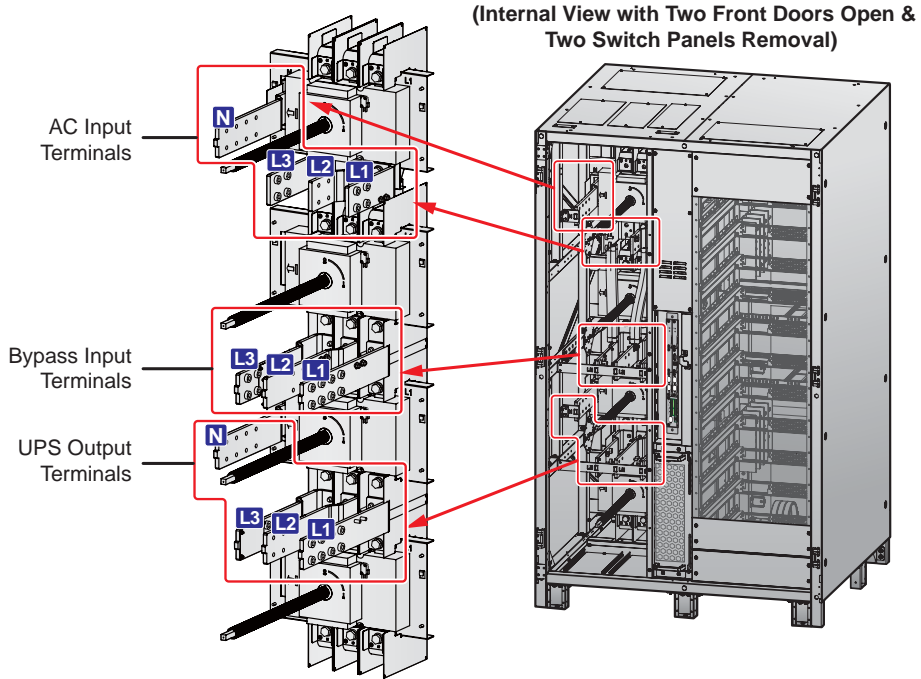

(Figure 2-7: Wiring Terminals_ AC Input, Bypass Input & UPS Output)

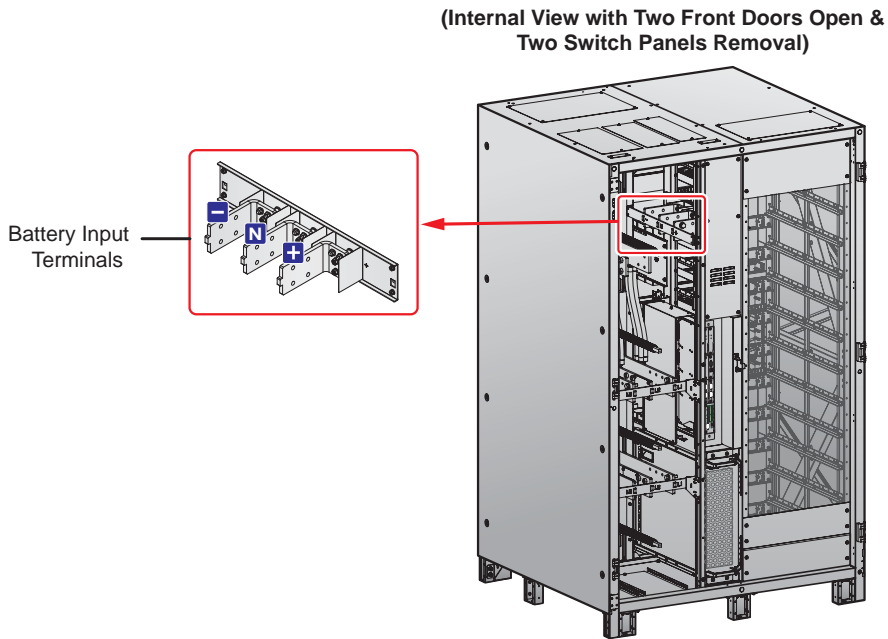

(Figure 2-8: Wiring Terminals_ Battery Input)

(Internal View with Two Front Doors Open & Two Switch Panels Removal)

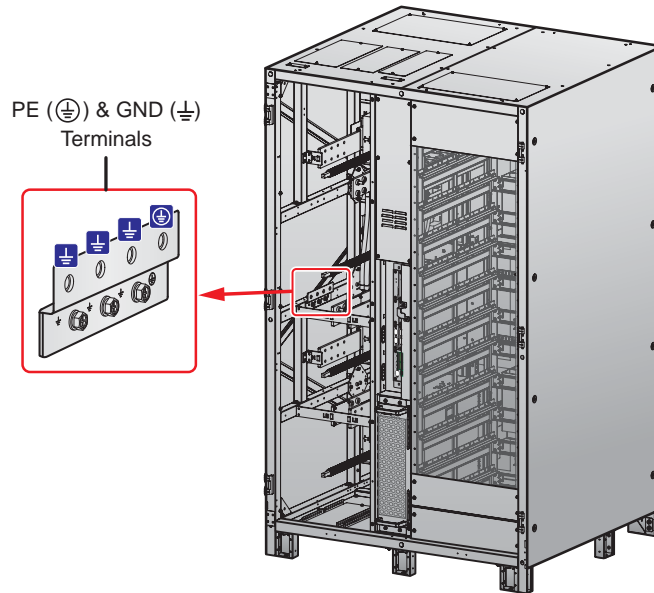

(Figure 2-9: Wiring Terminals_ Grounding)

2.7 Rear View



WARNING:

Only authorized Delta engineers or service personnel can perform installation, wiring, panel & cover removal, maintenance and operation. If you want to execute any action mentioned above by yourself, the action must be under the supervision of authorized Delta engineers or service personnel.

The rear view of the UPS is shown in **Figure 2-10**. There are no user operable or replaceable parts at the rear.

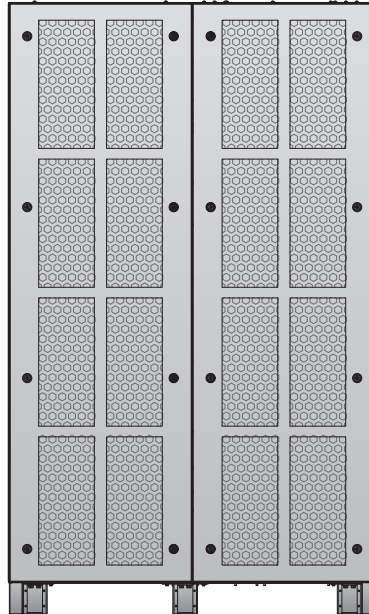

(Figure 2-10: UPS Rear View)

2.8 Tri-color LED Indicator & Buzzer

Please see **Figure 2-11** for the location of the tri-color LED indicator. For information about the tri-color LED indicator, please refer to **Table 2-1**. For information about the 10" color touch panel, please refer to **7. LCD Display & Settings**.



(Figure 2-11: Tri-color LED Indicator Location)

Face the front of the UPS, open the UPS's two front doors and find the buzzer at the rear of the UPS's left-side door. Please see **Figure 2-12**.

(Internal View with Two Front Doors Open)

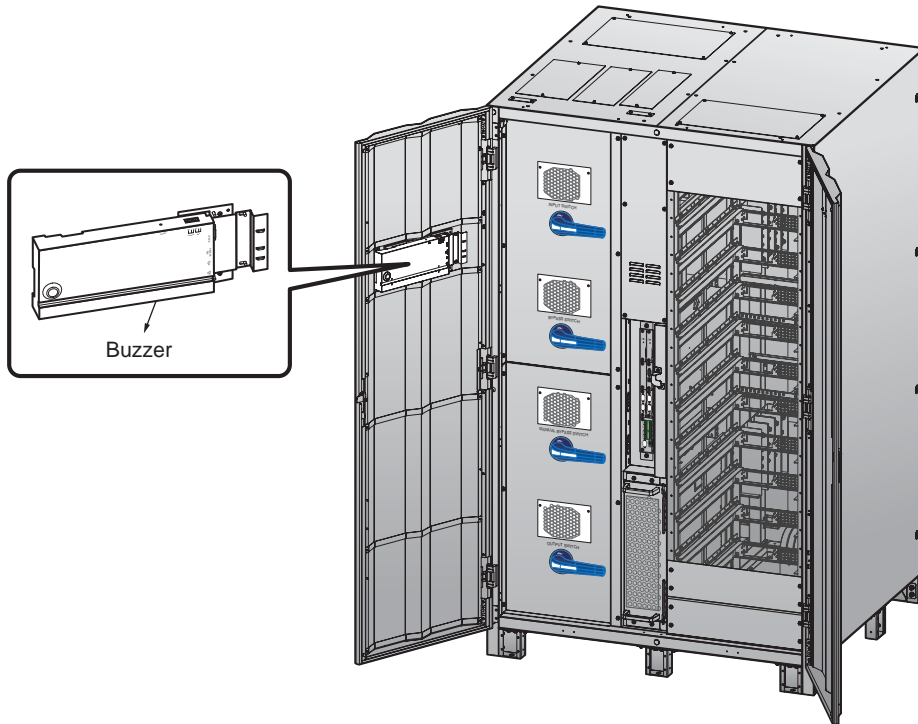

(Figure 2-12: Buzzer Location)

Table 2-1 outlines the status of the tri-color LED indicator, UPS operation mode, and buzzer.

Table 2-1: Tri-color LED Indicator, UPS Operation Mode & Buzzer

Tri-color LED Indicator	Status	Meaning										
Green	ON	<ul style="list-style-type: none">Indicates the UPS's current operation mode; for its corresponding text shown in the upper right corner of the LCD screen, please refer to the following table.										
		<table border="1"><thead><tr><th>UPS Operation Mode</th><th>Text on the LCD Screen (upper-right corner)</th></tr></thead><tbody><tr><td>Online Mode</td><td>'On-Line'</td></tr><tr><td>ECO Mode</td><td>'ECO'</td></tr><tr><td>Frequency Conversion Mode</td><td>'Frequency Conversion'</td></tr><tr><td>Green Mode</td><td>'Green'</td></tr></tbody></table>	UPS Operation Mode	Text on the LCD Screen (upper-right corner)	Online Mode	'On-Line'	ECO Mode	'ECO'	Frequency Conversion Mode	'Frequency Conversion'	Green Mode	'Green'
		UPS Operation Mode	Text on the LCD Screen (upper-right corner)									
		Online Mode	'On-Line'									
		ECO Mode	'ECO'									
Frequency Conversion Mode	'Frequency Conversion'											
Green Mode	'Green'											

Tri-color LED Indicator	Status	Meaning																		
Yellow	ON	<ul style="list-style-type: none"> <li data-bbox="573 291 1243 388">Indicates the UPS's current operation mode; for its corresponding text shown in the upper right corner of the LCD screen, please refer to the following table. <table border="1" data-bbox="605 401 1238 722"> <thead> <tr> <th data-bbox="605 401 920 484">UPS Operation Mode</th> <th data-bbox="920 401 1238 484">Text on the LCD Screen (upper-right corner)</th> </tr> </thead> <tbody> <tr> <td data-bbox="605 484 920 533">Bypass Mode</td> <td data-bbox="920 484 1238 533">'Bypass'</td> </tr> <tr> <td data-bbox="605 533 920 581">Battery Mode</td> <td data-bbox="920 533 1238 581">'Battery'</td> </tr> <tr> <td data-bbox="605 581 920 629">Standby Mode</td> <td data-bbox="920 581 1238 629">'Standby'</td> </tr> <tr> <td data-bbox="605 629 920 678">Softstart Mode</td> <td data-bbox="920 629 1238 678">'Softstart'</td> </tr> <tr> <td data-bbox="605 678 920 722">Energy Recycle Mode</td> <td data-bbox="920 678 1238 722">'Energy Recycle'</td> </tr> </tbody> </table> <li data-bbox="573 745 1243 803">Indicates a minor or medium warning, accompanied with buzzer sound. <table border="1" data-bbox="605 819 1238 1035"> <thead> <tr> <th data-bbox="605 819 920 871">Warning Level</th> <th data-bbox="920 819 1238 871">Buzzer Frequency</th> </tr> </thead> <tbody> <tr> <td data-bbox="605 871 920 954">Minor</td> <td data-bbox="920 871 1238 954">Sounds 0.5 second every 3 seconds.</td> </tr> <tr> <td data-bbox="605 954 920 1035">Medium</td> <td data-bbox="920 954 1238 1035">Sounds 0.5 second every second.</td> </tr> </tbody> </table> 	UPS Operation Mode	Text on the LCD Screen (upper-right corner)	Bypass Mode	'Bypass'	Battery Mode	'Battery'	Standby Mode	'Standby'	Softstart Mode	'Softstart'	Energy Recycle Mode	'Energy Recycle'	Warning Level	Buzzer Frequency	Minor	Sounds 0.5 second every 3 seconds.	Medium	Sounds 0.5 second every second.
UPS Operation Mode	Text on the LCD Screen (upper-right corner)																			
Bypass Mode	'Bypass'																			
Battery Mode	'Battery'																			
Standby Mode	'Standby'																			
Softstart Mode	'Softstart'																			
Energy Recycle Mode	'Energy Recycle'																			
Warning Level	Buzzer Frequency																			
Minor	Sounds 0.5 second every 3 seconds.																			
Medium	Sounds 0.5 second every second.																			
Red	ON	<ul style="list-style-type: none"> <li data-bbox="573 1074 1243 1132">Indicates a major warning, accompanied with buzzer sound. <table border="1" data-bbox="605 1147 1238 1244"> <thead> <tr> <th data-bbox="605 1147 920 1199">Warning Level</th> <th data-bbox="920 1147 1238 1199">Buzzer Frequency</th> </tr> </thead> <tbody> <tr> <td data-bbox="605 1199 920 1244">Major</td> <td data-bbox="920 1199 1238 1244">Long beep.</td> </tr> </tbody> </table> 	Warning Level	Buzzer Frequency	Major	Long beep.														
Warning Level	Buzzer Frequency																			
Major	Long beep.																			

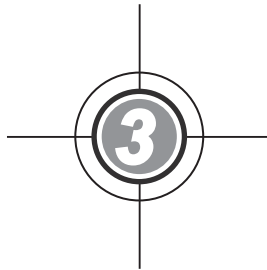

Operation Modes

- 3.1 Single Input
- 3.2 Dual Input
- 3.3 Hot Standby Redundancy
(Only for Dual Input & At
Least Two UPSs)
- 3.4 Common Battery (Only for
Parallel UPSs Connecting
to the Same External
Battery Cabinet(s))

The UPS runs in eight basic operation modes, which are On-Line mode, Battery mode, Bypass mode, Manual Bypass mode, ECO mode, Frequency Conversion mode, Green mode and Energy Recycle mode. Besides these eight operation modes, the UPS is also designed for common battery application and hot standby redundancy. Please see the following sections for relevant information.



NOTE:

In this user manual, the meaning of Q1, Q2, Q3, Q4 and Q5 is shown as follows.

Code	Meaning
Q1	Input Switch
Q2	Bypass Switch
Q3	Manual Bypass Switch
Q4	Output Switch
Q5	External Battery Cabinet's Breaker

3.1 Single Input

3.1.1 On-Line Mode_ Single Input_ Single Unit

In On-Line mode, the main AC source supplies AC power via the Input Switch (Q1) to the rectifier, and the rectifier converts the AC power to DC power and supplies the DC power to the inverter. In the meantime, the rectifier provides charging power to the batteries. After receiving the DC power, the inverter converts it into clean and stable AC power to the connected critical loads via the Output Switch (Q4). Please refer to **Figure 3-1**. During On-Line mode, the UPS's tri-color LED illuminates green and the text 'On-Line' appears in the upper right corner of the screen.

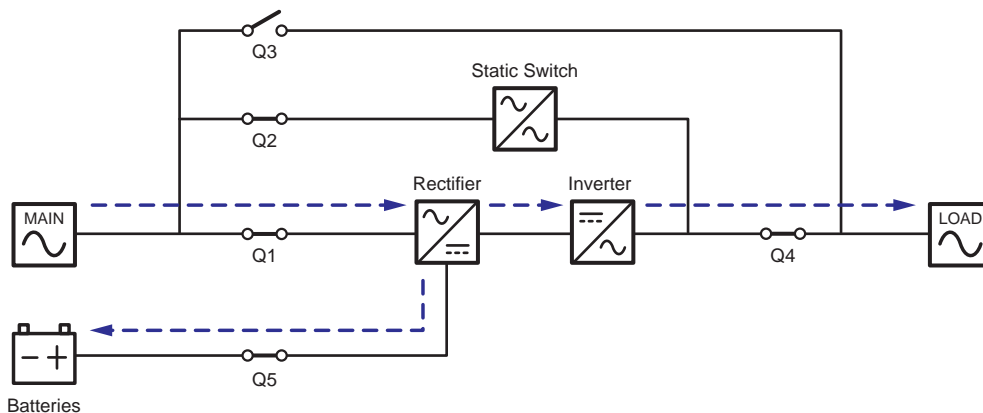

(Figure 3-1: On-Line Mode Diagram_ Single Input Single Unit)

3.1.2 Battery Mode_ Single Input_ Single Unit

The UPS transfers to Battery mode automatically if the main AC source is abnormal, for example, when unstable voltage or a power outage occurs. In Battery mode, the batteries provide DC power and the UPS converts it into AC power and supplies it to the connected critical loads via the Output Switch (Q4). During the conversion process, output voltage remains the same. Please see **Figure 3-2** for Battery mode diagram. During Battery mode, the UPS's tri-color LED illuminates yellow and the text 'Battery' appears in the upper right corner of the screen.

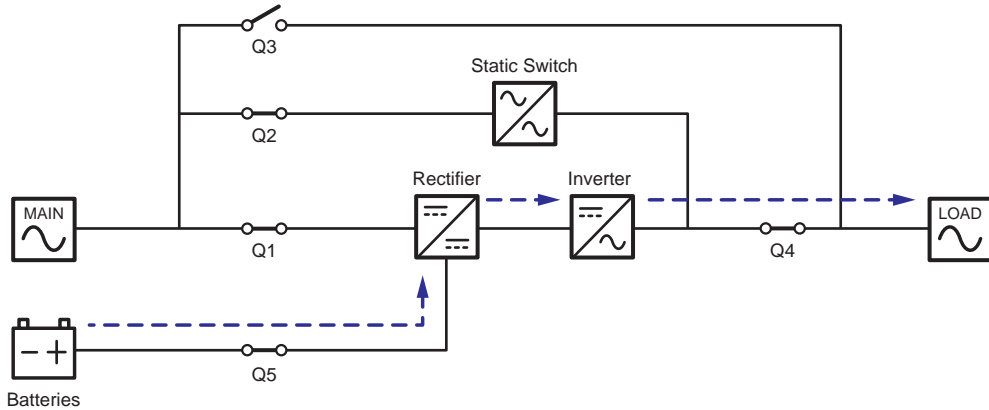

(Figure 3-2: Battery Mode Diagram_ Single Input Single Unit)

3.1.3 Bypass Mode_ Single Input_ Single Unit

When the inverter encounters abnormal situations such as over temperature, overload, short circuit, abnormal output voltage or low battery, it will automatically shut itself down. If the UPS detects the bypass AC source is normal, it will automatically switch to Bypass mode to protect the connected critical loads from power interruption. Please refer to **Figure 3-3**. After the above-mentioned abnormalities are eliminated, the UPS will switch back to On-Line mode from Bypass mode. During Bypass mode, the UPS's tri-color LED illuminates yellow and the text 'Bypass' appears in the upper right corner of the screen.

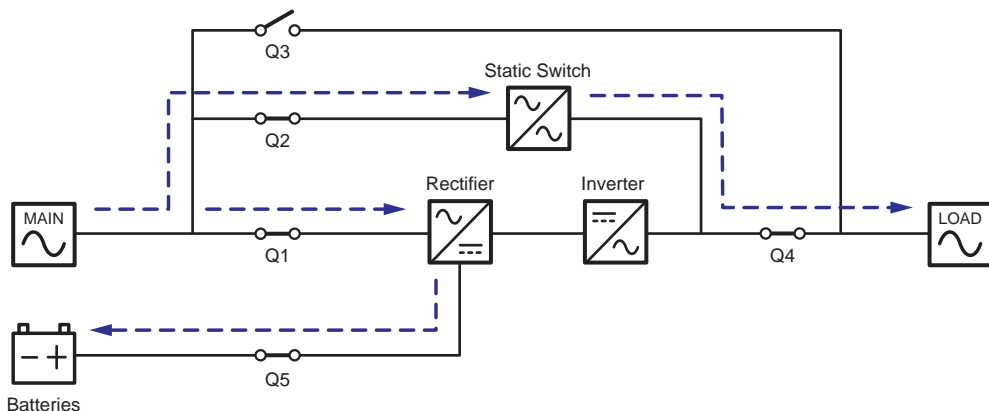

(Figure 3-3: Bypass Mode Diagram_ Single Input Single Unit)

3.1.4 Manual Bypass Mode_ Single Input_ Single Unit



WARNING:

1. In Manual Bypass mode, make sure that all of the breakers (except the Manual Bypass Switch (Q3)) are in the **OFF** position before working on the UPS's internal circuits. This avoids electric shock.
2. After the power inside the UPS is completely cut off, there is no high voltage inside the UPS and maintenance can be performed safely. However, to avoid electric shock, please do not touch the following parts: AC Input terminal block, Bypass Input terminal block, UPS Output terminal block, Battery Input terminal block, grounding terminals (see **Figure 5-8 ~ Figure 5-10** for the location of these terminal blocks and terminals) and any copper bars connected to the Manual Bypass Switch (Q3), as they may carry high voltage.
3. During Manual Bypass mode, the UPS's input power is completely cut off and the connected critical loads are not protected.

When the UPS needs maintenance, you can manually switch the UPS to Manual Bypass mode. To let the UPS run in Manual Bypass mode, please follow the procedures below:

- 1 Confirm that the bypass AC source and the STS module are normal.
- 2 Tap the LCD's ON/ OFF Button () and the 'POWER OFF?' screen will pop up to ask if you want to power off the UPS's inverter. Please select 'YES'.
- 3 Turn **ON** the Manual Bypass Switch (Q3).
- 4 Turn **OFF** the Bypass Switch (Q2).
- 5 Turn **OFF** the Input Switch (Q1) and Output Switch (Q4).
- 6 Turn **OFF** each external battery cabinet's breaker (Q5).

In Manual Bypass mode, all power inside the UPS is completely cut off and maintenance personnel can perform maintenance safely. Please see **Figure 3-4** for Manual Bypass mode diagram. During Manual Bypass mode, the UPS's tri-color LED and LCD are both off.

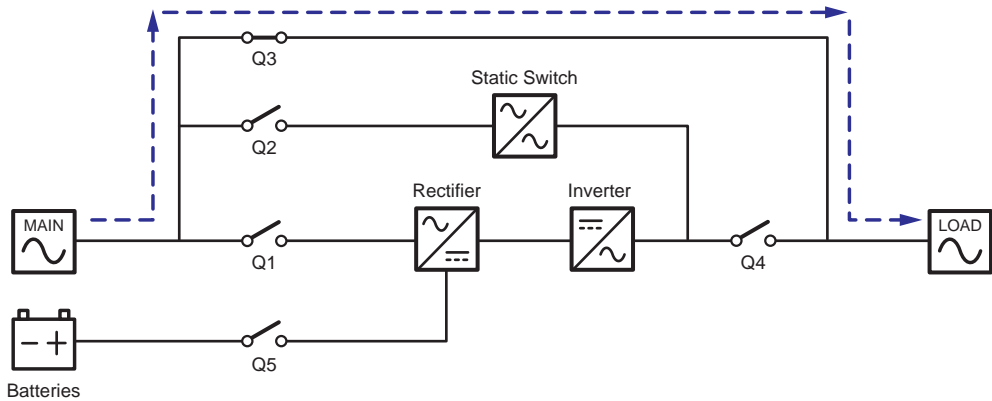

(Figure 3-4: Manual Bypass Mode Diagram_ Single Input Single Unit)

3.1.5 ECO Mode_ Single Input_ Single Unit

To activate ECO mode, please refer to **6.2.5 ECO Mode Start-up Procedures**, **7.6 Main Screen** and **7.10.2 Mode Setting**.

In ECO mode, when bypass AC source's input voltage and frequency are within the range of rating voltage $\pm 10\%$ and rating frequency $\pm 3\text{Hz}$ respectively, the UPS works in Bypass mode; otherwise, the UPS runs in On-Line mode. For ECO mode diagram, please see **Figure 3-5**. During ECO mode, the UPS's tri-color LED illuminates green and the text 'ECO' appears in the upper right corner of the screen.

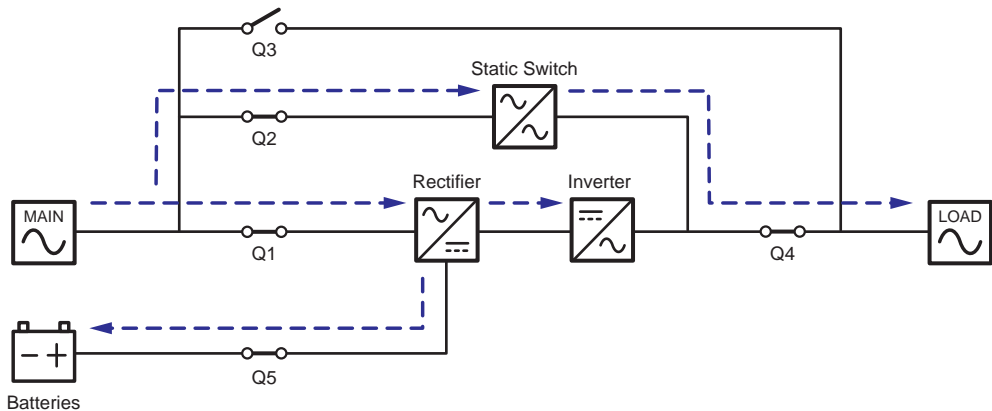

(Figure 3-5: ECO Mode Diagram_ Single Input Single Unit)

3.1.6 Frequency Conversion Mode_ Single Input_ Single Unit



NOTE:

1. Frequency Conversion mode is only applicable to single UPS but not to parallel UPSs.
2. When the UPS runs in Frequency Conversion mode, once the inverter becomes off, there is no bypass power supplying to the loads.

To activate Frequency Conversion mode, please refer to **6.2.6 Frequency Conversion Mode Start-up Procedures**, **7.6 Main Screen** and **7.10.2 Mode Setting**.

After the UPS is manually set in Frequency Conversion mode, the inverter will automatically select 50Hz or 60Hz as the fixed output frequency. After the output frequency is determined, the system will automatically disable the bypass function. Please note that, once the inverter shuts down, there is no bypass output. For the diagram of Frequency Conversion mode, please see **Figure 3-6**. During Frequency Conversion mode, the UPS's tri-color LED illuminates green and the text 'Frequency Conversion' appears in the upper right corner of the screen.

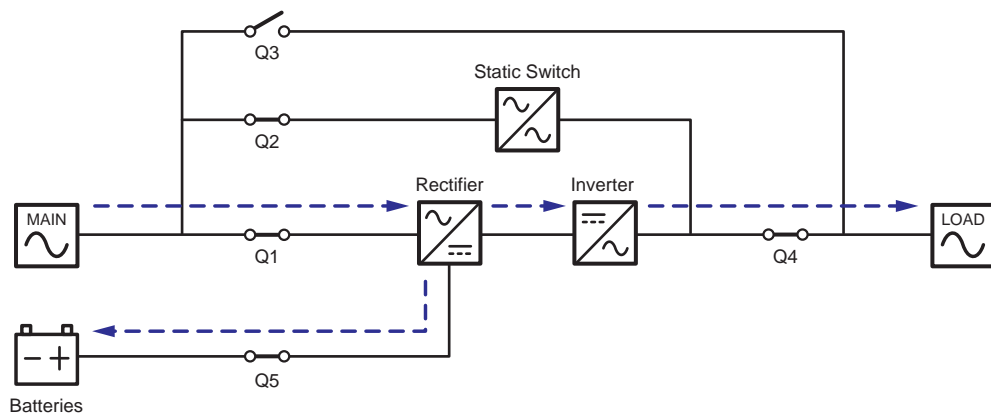

(Figure 3-6: Frequency Conversion Mode Diagram_ Single Input Single Unit)

3.1.7 Green Mode_ Single Input_ Single Unit

To activate Green mode, please refer to **6.2.7 Green Mode Start-up Procedures**, **7.6 Main Screen** and **7.10.2 Mode Setting**.

Green mode is the same as On-Line mode, but the difference is that the system will automatically detect the output status (i.e. total load capacity %) to decide which specific power modules should be fully powered on or idle in order to achieve higher efficiency of the UPS. For the Green mode diagram, please see **Figure 3-7**. During Green mode, the UPS's tri-color LED illuminates green and the text 'Green' appears in the upper right corner of the screen.

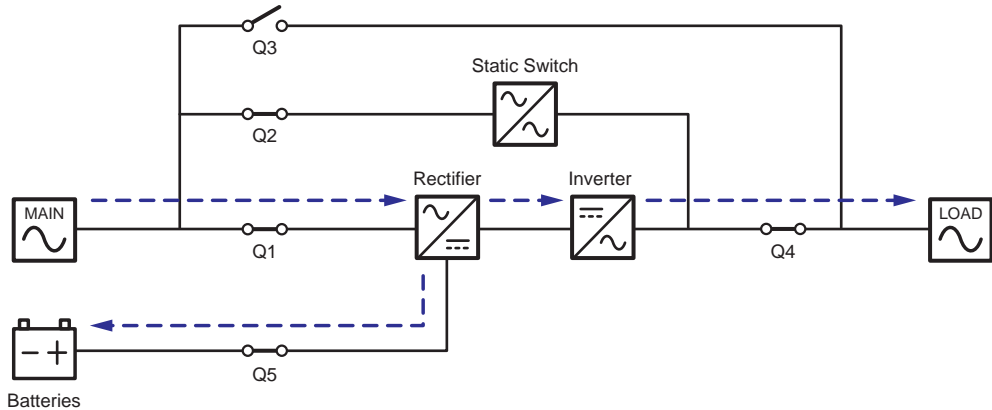

(Figure 3-7: Green Mode Diagram_Single Input Single Unit)

3.1.8 Energy Recycle Mode_Single Input_Single Unit



NOTE:

1. Energy Recycle mode is only applicable to single input and single unit application.
2. Do not let the UPS run in Energy Recycle mode when the batteries are supplying power to the loads.
3. Only qualified personnel can perform the following operations.

Energy Recycle mode is only applicable to UPS self-test only. Without connection to any critical loads, the UPS can execute current test under full load condition. Before you activate Energy Recycle mode, please make sure that the Manual Bypass Switch (Q3), Output Switch (Q4) and each external battery cabinet's battery breaker (Q5) are in the **OFF** status.

To activate Energy Recycle mode, please refer to **6.2.8 Energy Recycle Mode Start-up Procedures**, **7.6 Main Screen** and **7.10.2 Mode Setting**.

For the diagram of Energy Recycle mode, please see **Figure 3-8**. During Energy Recycle mode, the UPS's tri-color LED illuminates yellow and the text 'Energy Recycle' appears in the upper right corner of the screen.

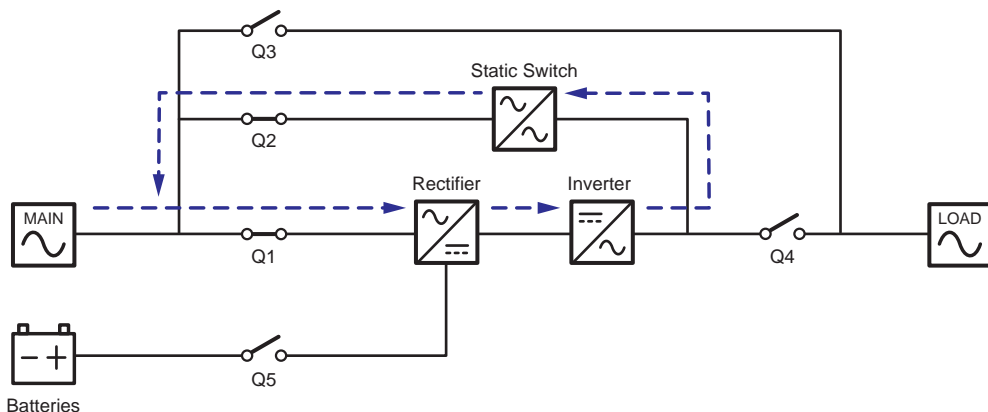

(Figure 3-8: Energy Recycle Mode Diagram_Single Input Single Unit)

3.1.9 On-Line Mode_ Single Input_ Parallel Units

In On-Line mode (parallel), the total loads will be equally shared by parallel UPSs. If one of the parallel units fails and its load is less than the total capacity of the remaining parallel units, the failing UPS's output will be switched off and its load will be equally shared by the remaining parallel units. If the failing UPS's load is larger than the total capacity of the remaining parallel units, all UPSs' inverters will turn off and the total loads will be supplied by bypass power. During On-Line mode (parallel), each UPS's tri-color LED illuminates green and each UPS's LCD shows the text 'On-Line' in the upper right corner. Please refer to **Figure 3-9** for the path of electrical power through the parallel UPSs in On-Line mode.

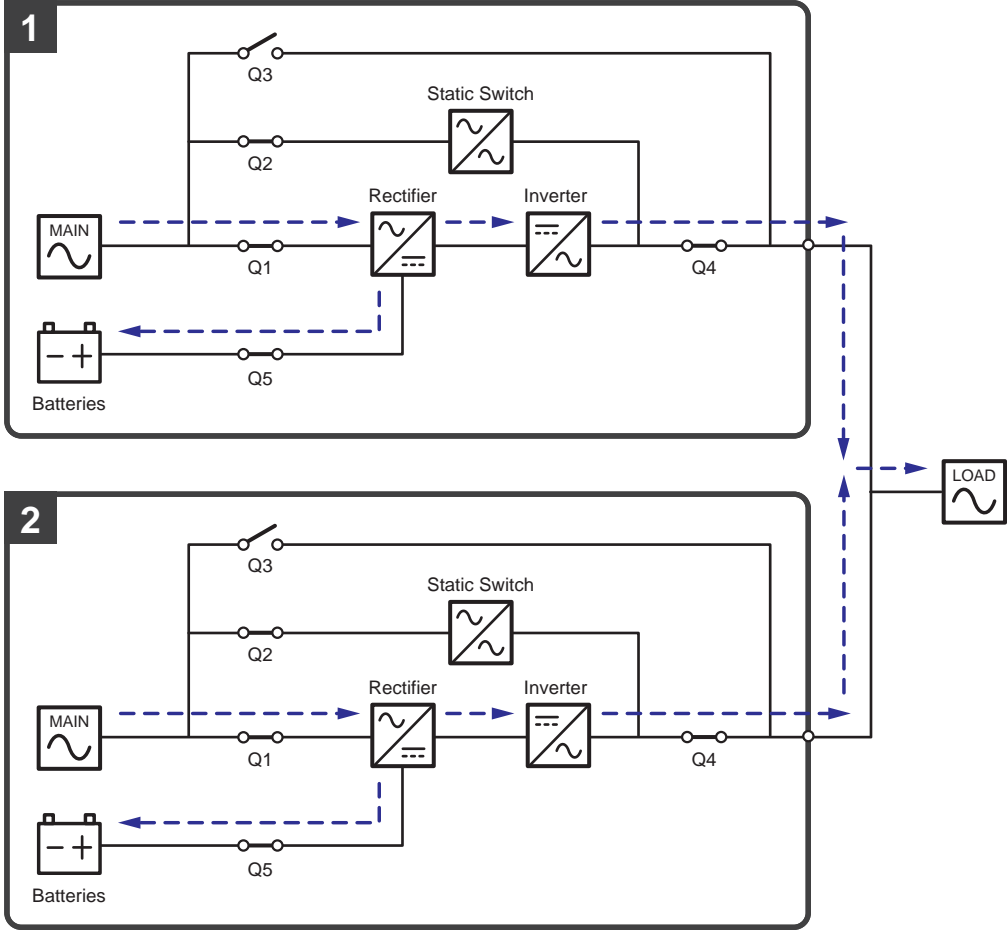

(Figure 3-9: On-Line Mode Diagram_ Single Input Parallel Units)

3.1.10 Battery Mode_ Single Input_ Parallel Units

If the main AC source is abnormal, for example, when unstable voltage or a power outage occurs, all parallel UPSs will automatically transfer from On-Line mode to Battery mode. During the conversion process, output voltage remains the same. During Battery mode (parallel), each UPS's tri-color LED illuminates yellow and each UPS's LCD shows the text 'Battery' in the upper right corner. Please refer to **Figure 3-10** for the path of electrical power through the parallel UPSs in Battery mode.

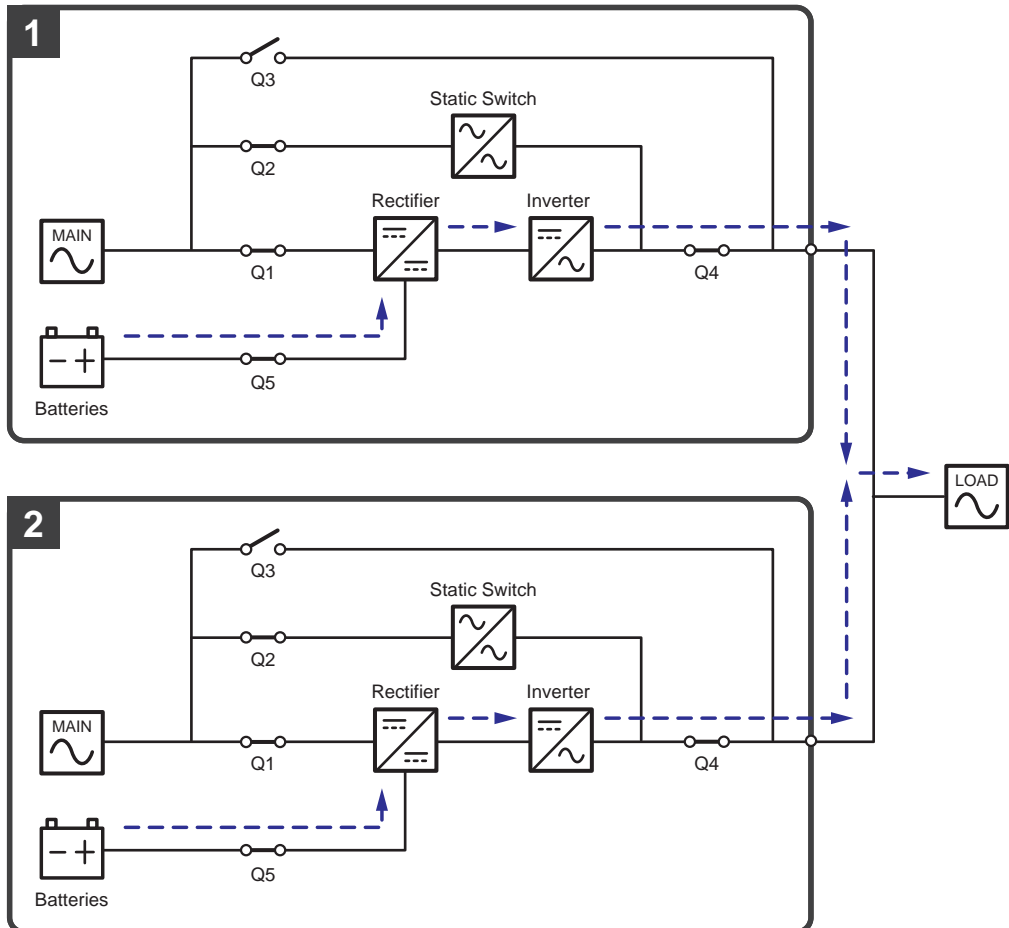

(Figure 3-10: Battery Mode Diagram_ Single Input Parallel Units)

3.1.11 Bypass Mode_ Single Input_ Parallel Units

In Bypass mode (parallel), when all inverters encounter abnormal situations such as overload, short circuit, abnormal output voltage or low battery, they will automatically shut themselves down. Meanwhile, if all parallel UPSs detect the bypass AC source is normal, they will automatically switch to Bypass mode to protect the connected critical loads from power interruption. The critical loads will be equally shared by all parallel units. After the abnormalities mentioned above are eliminated, the parallel UPSs will switch back to On-Line mode from Bypass mode. During Bypass mode (parallel), each UPS's tri-color LED illuminates yellow and each UPS's LCD shows the text 'Bypass' in the upper right corner. Please refer to **Figure 3-11** for the path of electrical power through the parallel UPSs in Bypass mode.

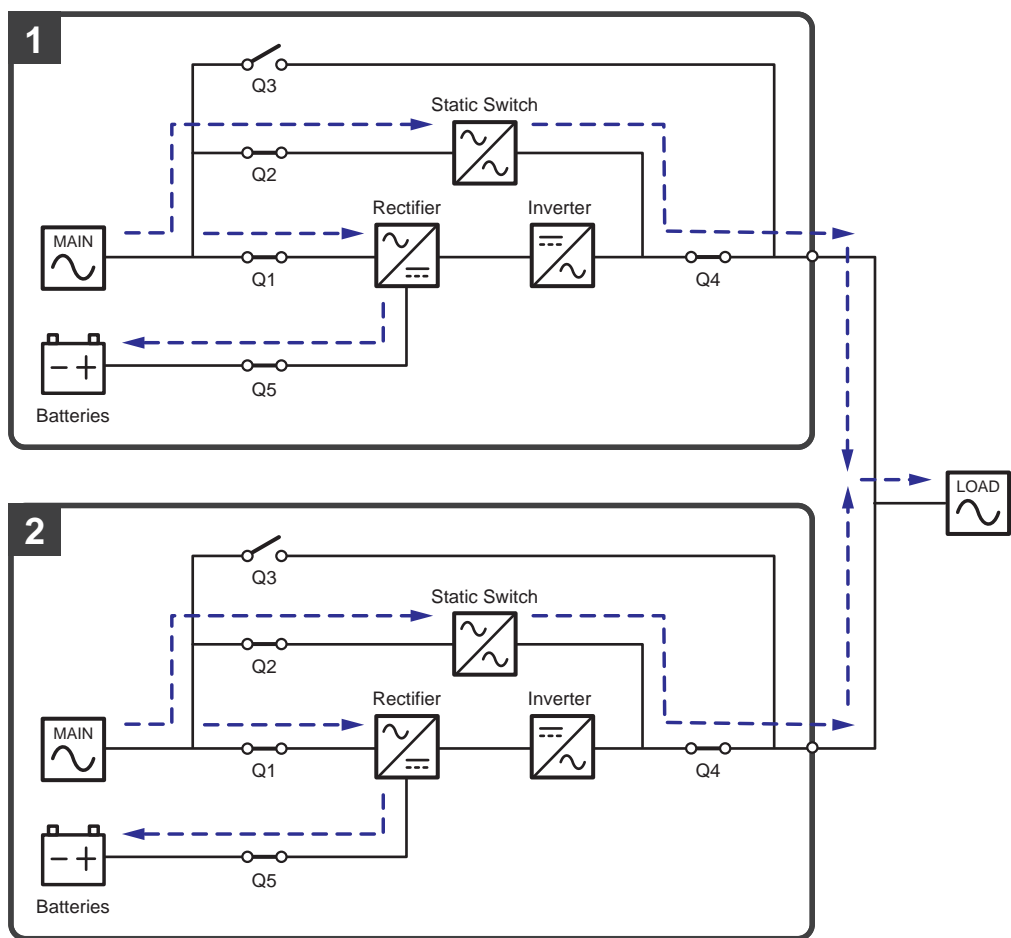

(Figure 3-11: Bypass Mode Diagram_ Single Input Parallel Units)

3.1.12 Manual Bypass Mode_ Single Input_ Parallel Units



WARNING:

1. In Manual Bypass mode, make sure that all of the breakers (except each Manual Bypass Switch (Q3)) are in the **OFF** position before working on any of the parallel UPSs' internal circuits. This avoids electric shock.
2. After the power inside each of the parallel UPSs is completely cut off, there is no high voltage inside all parallel UPSs and maintenance can be performed safely. However, to avoid electric shock, please do not touch the following parts on each parallel UPS: AC Input terminal block, Bypass Input terminal block, UPS Output terminal block, Battery Input terminal block, grounding terminals (see **Figure 5-8 ~ Figure 5-10** for the location of these terminal blocks and terminals) and any copper bars connected to the Manual Bypass Switch (Q3), as they may carry high voltage.
3. During Manual Bypass mode, each parallel UPS's input power is completely cut off and the connected critical loads are not protected.
4. For parallel UPSs, if you want to turn off one of the parallel UPSs for maintenance, please make sure the total connected critical loads will not exceed the remaining parallel units' total capacity.

In Manual Bypass mode (parallel), if one of the parallel UPSs needs maintenance, please first confirm that the bypass AC source and each parallel UPS's STS module are normal. After confirmation, please follow the procedures below to manually switch each of the parallel UPSs to Manual Bypass mode.

- 1 Tap each LCD's ON/ OFF Button () and the 'POWER OFF?' screen will pop up to ask if you want to power off the UPS's inverter. Please select 'YES'.
- 2 Turn **ON** each UPS's Manual Bypass Switch (Q3).
- 3 Turn **OFF** each UPS's Bypass Switch (Q2).
- 4 Turn **OFF** each UPS's Input Switch (Q1) and Output Switch (Q4).
- 5 Turn **OFF** each external battery cabinet's breaker (Q5).

In Manual Bypass mode, all power inside the parallel UPSs is completely cut off and maintenance personnel can perform maintenance safely. Power of the connected critical loads will be supplied by manual bypass. During Manual Bypass mode (parallel), all parallel UPSs' tri-color LEDs and LCDs are off. Please see **Figure 3-12** for the path of electrical power through the parallel UPSs in Manual Bypass mode.

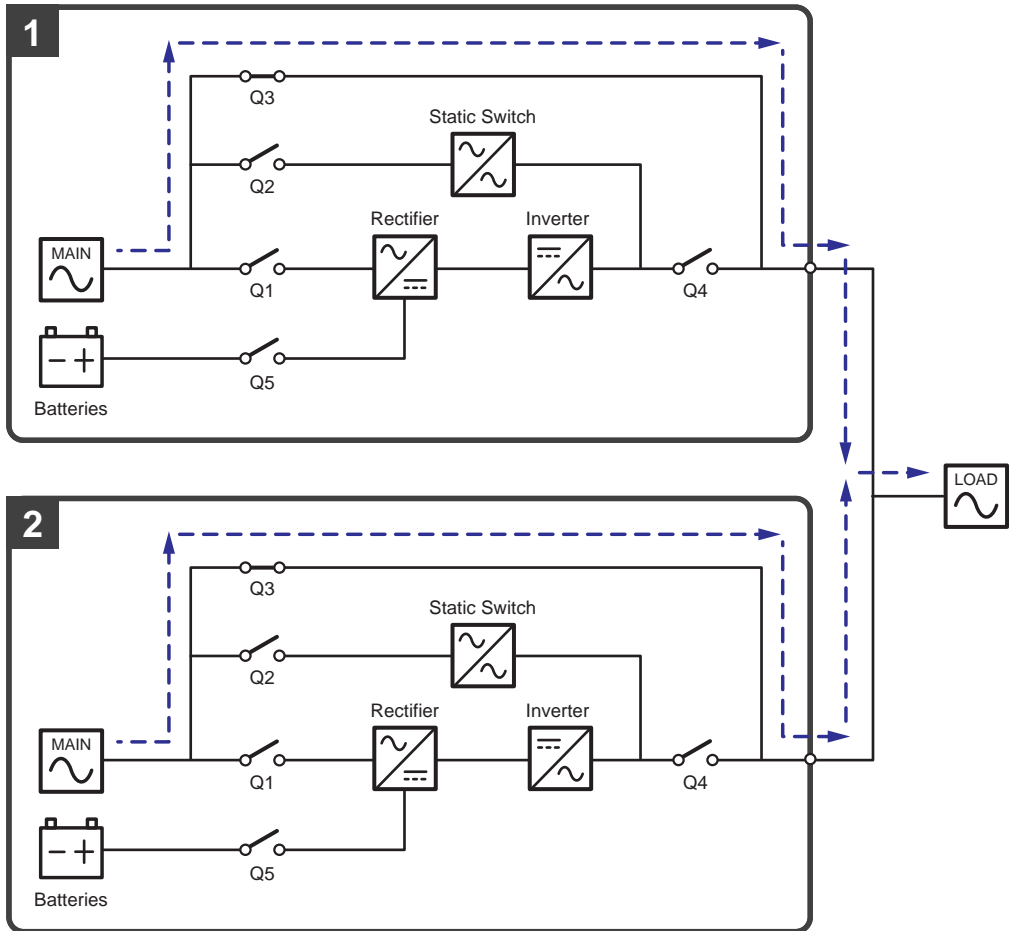

(Figure 3-12: Manual Bypass Mode Diagram_ Single Input Parallel Units)

3.1.13 ECO Mode_ Single Input_ Parallel Units

To activate ECO mode, please refer to **6.2.5 ECO Mode Start-up Procedures**, **7.6 Main Screen** and **7.10.2 Mode Setting**.

In ECO mode (parallel), when each parallel UPS's bypass input voltage and frequency are within the range of rating voltage $\pm 10\%$ and rating frequency $\pm 3\text{Hz}$ respectively, each parallel UPS works in Bypass mode; otherwise, each parallel UPS runs in On-Line mode. During ECO mode (parallel), each UPS's tri-color LED illuminates green and each UPS's LCD shows the text 'ECO' in the upper right corner. Please see **Figure 3-13** for the path of electrical power through the parallel UPSs in ECO mode.

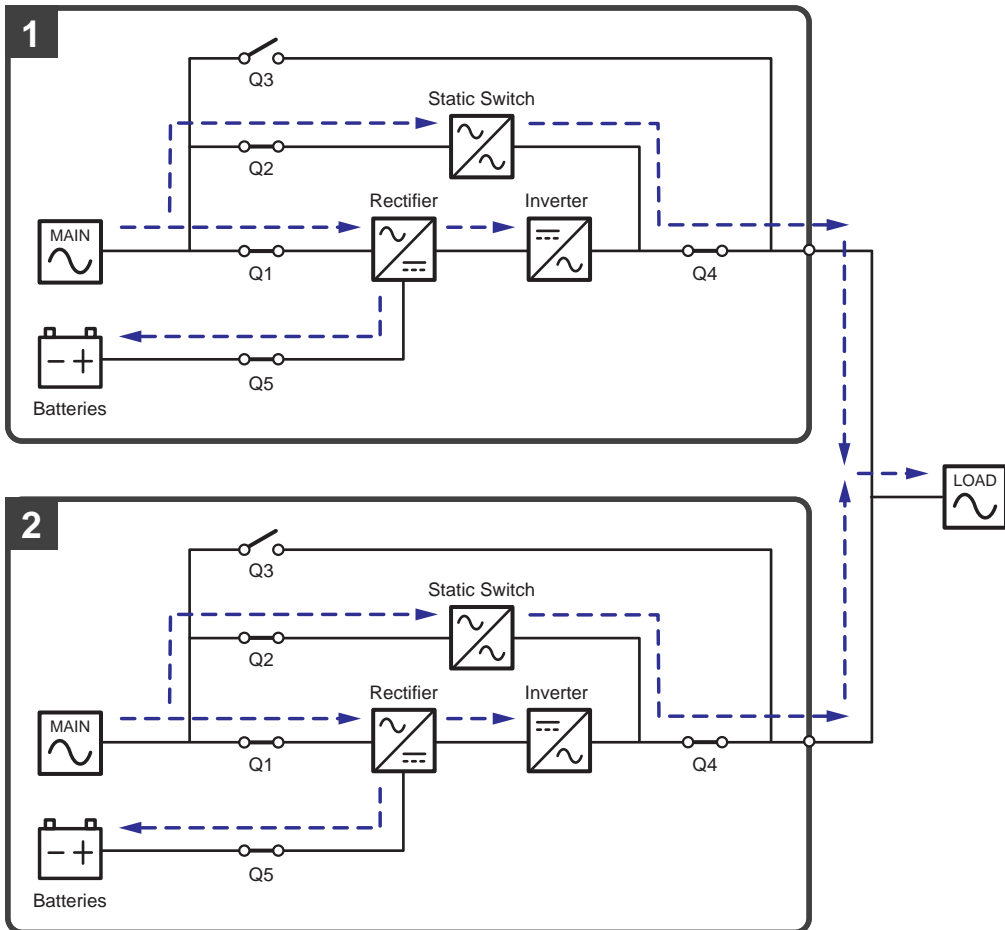

(Figure 3-13: ECO Mode Diagram_ Single Input Parallel Units)

3.1.14 Green Mode_ Single Input_ Parallel Units

To activate Green mode, please refer to **6.2.7 Green Mode Start-up Procedures**, **7.6 Main Screen** and **7.10.2 Mode Setting**.

For parallel application, Green mode is the same as On-Line mode, but the difference is that each parallel UPS's system will automatically detect its own output status (i.e. total load capacity %) to decide which specific power modules should be fully powered on or idle in order to achieve higher efficiency of the UPS. During Green mode (parallel), each UPS's tri-color LED illuminates green and each UPS's LCD shows the text 'Green' in the upper right corner. Please see **Figure 3-14** for the path of electrical power through the parallel UPSs in Green mode.

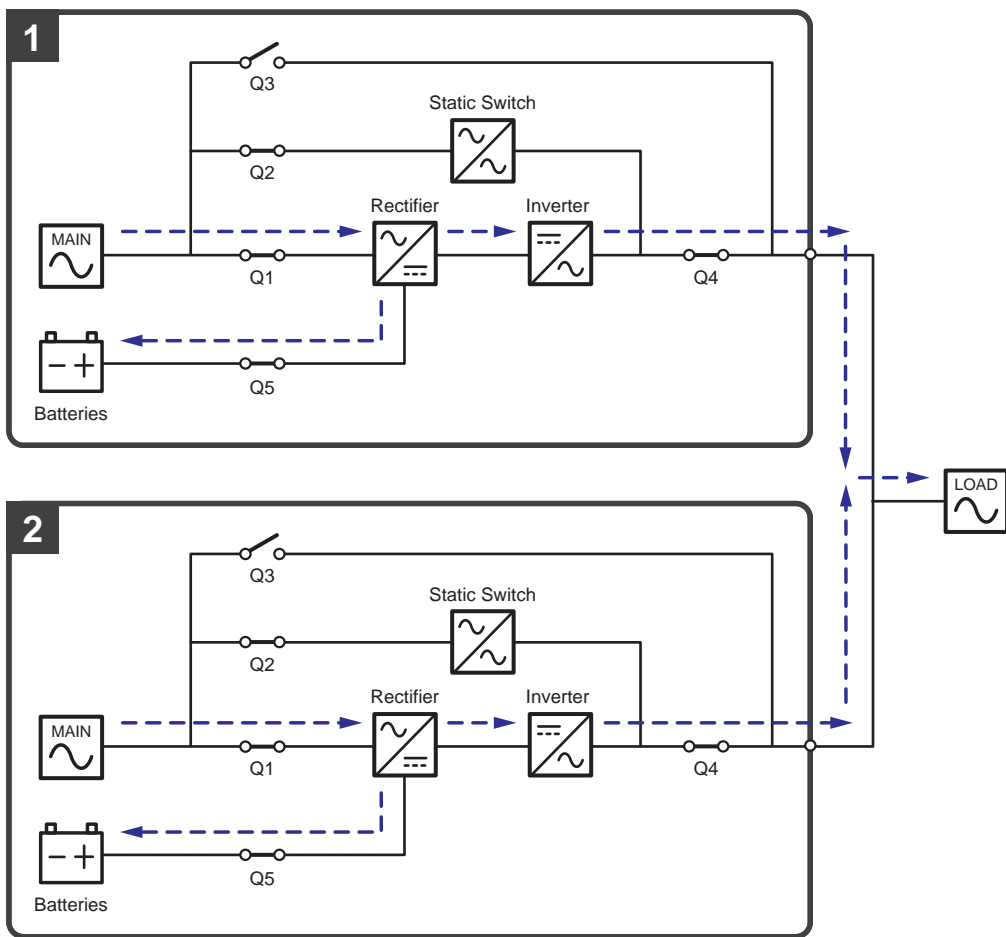

(Figure 3-14: Green Mode Diagram_ Single Input Parallel Units)

3.2 Dual Input

3.2.1 On-Line Mode_ Dual Input_ Single Unit

In On-Line mode, the main AC source supplies AC power via the Input Switch (Q1) to the rectifier, and the rectifier converts the AC power to DC power and supplies the DC power to the inverter. In the meantime, the rectifier provides charging power to the batteries. After receiving the DC power, the inverter converts it into clean and stable AC power to the connected critical loads via the Output Switch (Q4). Please see **Figure 3-15** for the On-Line mode diagram. During On-Line mode, the UPS's tri-color LED illuminates green and the text 'On-Line' appears in the upper right corner of the screen.

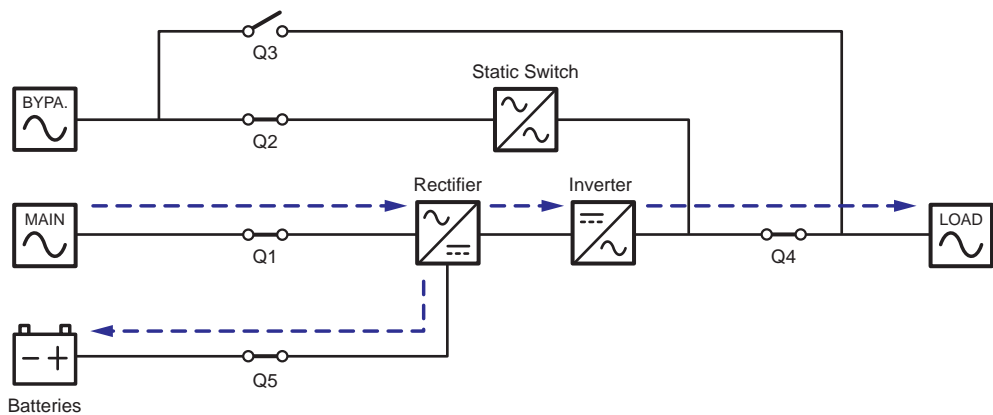

(Figure 3-15: On-Line Mode Diagram_ Dual Input Single Unit)

3.2.2 Battery Mode_ Dual Input_ Single Unit

The UPS transfers to Battery mode automatically if the main AC source is abnormal, for example, when unstable voltage or a power outage occurs. In Battery mode, the batteries provide DC power and the UPS converts it into AC power and supplies it to the connected critical loads via the Output Switch (Q4). During the conversion process, output voltage remains the same. Please see **Figure 3-16** for the Battery mode diagram. During Battery mode, the UPS's tri-color LED illuminates yellow and the text 'Battery' appears in the upper right corner of the screen.

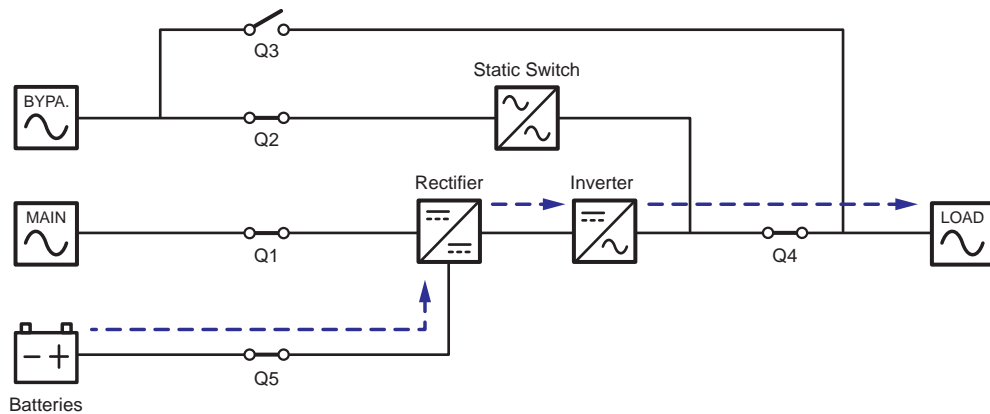

(Figure 3-16: Battery Mode Diagram_ Dual Input Single Unit)

3.2.3 Bypass Mode_ Dual Input_ Single Unit

When the inverter encounters abnormal situations such as over temperature, overload, short circuit, abnormal output voltage or low battery, it will automatically shut itself down. If the UPS detects the bypass AC source is normal, it will automatically switch to Bypass mode to protect the connected critical loads from power interruption. Please refer to **Figure 3-17**. After the above-mentioned abnormalities are eliminated, the UPS will switch back to On-Line mode from Bypass mode. During Bypass mode, the UPS's tri-color LED illuminates yellow and the text 'Bypass' appears in the upper right corner of the screen.

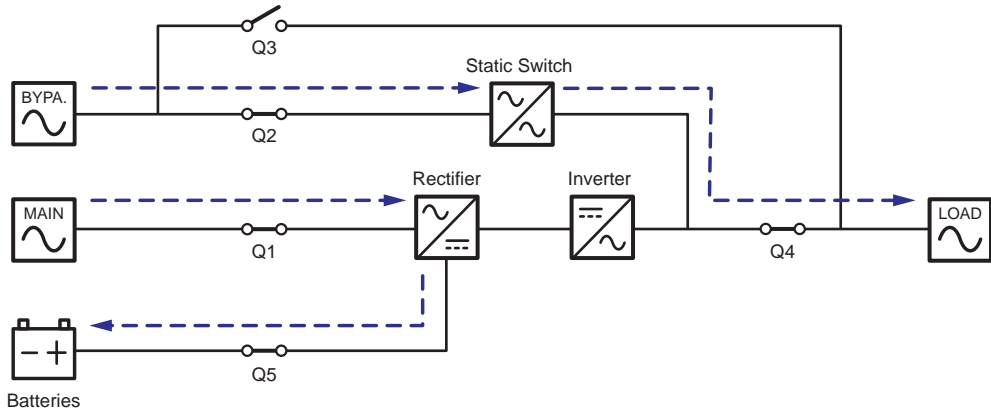

(Figure 3-17: Bypass Mode Diagram_Dual Input_Single Unit)

3.2.4 Manual Bypass Mode_Dual Input_Single Unit



WARNING:

1. In Manual Bypass mode, make sure that all of the breakers (except the Manual Bypass Switch (Q3)) are in the **OFF** position before working on the UPS's internal circuits. This avoids electric shock.
2. After the power inside the UPS is completely cut off, there is no high voltage inside the UPS and maintenance can be performed safely. However, to avoid electric shock, please do not touch the following parts: AC Input terminal block, Bypass Input terminal block, UPS Output terminal block, Battery Input terminal block, grounding terminals (see **Figure 5-8 ~ Figure 5-10** for the location of these terminal blocks and terminals) and any copper bars connected to the Manual Bypass Switch (Q3), as they may carry high voltage.
3. During Manual Bypass mode, the UPS's input power is completely cut off and the connected critical loads are not protected.

When the UPS needs maintenance, you can manually switch the UPS to Manual Bypass mode. To let the UPS run in Manual Bypass mode, please follow the procedures below:

- 1) Confirm that the bypass AC source and the STS module are normal.
- 2) Tap the LCD's ON/ OFF Button () and the '**POWER OFF?**' screen will pop up to ask if you want to power off the UPS's inverter. Please select '**YES**'.
- 3) Turn **ON** the Manual Bypass Switch (Q3).
- 4) Turn **OFF** the Bypass Switch (Q2).
- 5) Turn **OFF** the Input Switch (Q1) and Output Switch (Q4).
- 6) Turn **OFF** each external battery cabinet's breaker (Q5).

In Manual Bypass mode, all power inside the UPS is completely cut off and maintenance personnel can perform maintenance safely. Please see **Figure 3-18** for the Manual Bypass mode diagram. During Manual Bypass mode, the UPS's tri-color LED and LCD are both off.

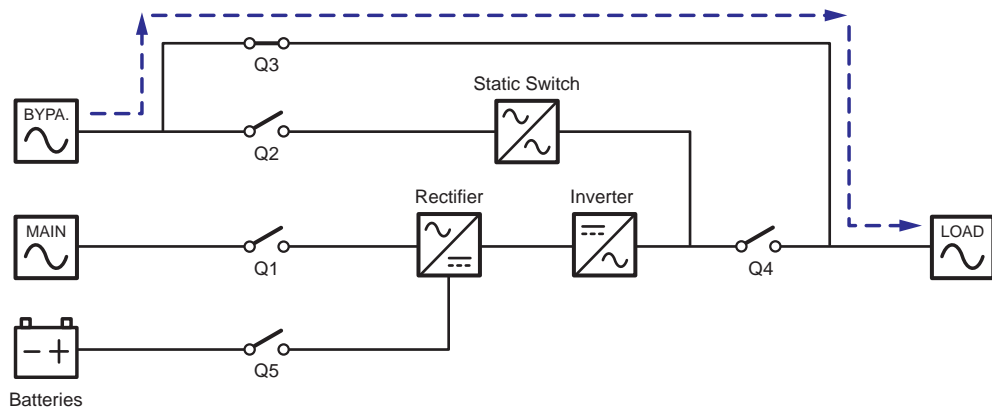

(Figure 3-18: Manual Bypass Mode Diagram_Dual Input Single Unit)

3.2.5 ECO Mode_Dual Input_Single Unit

To activate ECO mode, please refer to **6.2.5 ECO Mode Start-up Procedures**, **7.6 Main Screen** and **7.10.2 Mode Setting**.

In ECO mode, when the bypass AC source's input voltage and frequency are within the range of rating voltage $\pm 10\%$ and rating frequency $\pm 3\text{Hz}$ respectively, the UPS works in Bypass mode; otherwise, the UPS runs in On-Line mode. For ECO mode diagram, please see **Figure 3-19**. During ECO mode, the UPS's tri-color LED illuminates green and the text 'ECO' appears in the upper right corner of the screen.

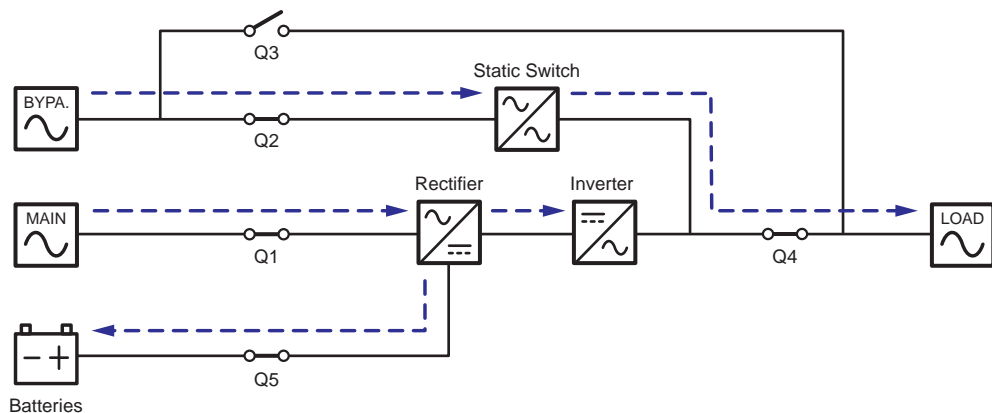

(Figure 3-19: ECO Mode Diagram_Dual Input Single Unit)

3.2.6 Frequency Conversion Mode_ Dual Input_ Single Unit



NOTE:

1. Frequency Conversion mode is only applicable to single UPS but not to parallel UPSs.
2. When the UPS runs in Frequency Conversion mode, once the inverter becomes off, there is no bypass power supplying to the loads.

To activate Frequency Conversion mode, please refer to **6.2.6 Frequency Conversion Mode Start-up Procedures**, **7.6 Main Screen** and **7.10.2 Mode Setting**.

After the UPS is manually set in Frequency Conversion mode, the inverter will automatically select 50Hz or 60Hz as the fixed output frequency. After the output frequency is determined, the system will automatically disable the bypass function. Please note that, once the inverter shuts down, there is no bypass output. For the diagram of Frequency Conversion mode, please see **Figure 3-20**. During Frequency Conversion mode, the UPS's tri-color LED illuminates green and the text 'Frequency Conversion' appears in the upper right corner of the screen.

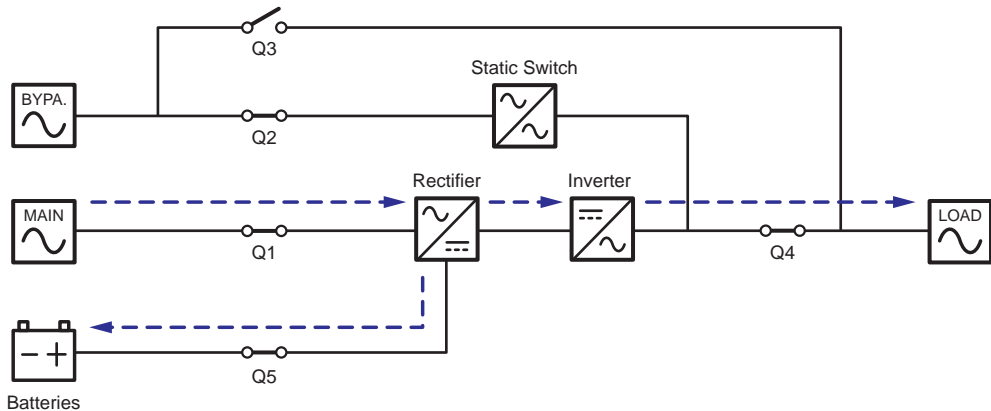

(Figure 3-20: Frequency Conversion Mode Diagram_ Dual Input Single Unit)

3.2.7 Green Mode_ Dual Input_ Single Unit

To activate Green mode, please refer to **6.2.7 Green Mode Start-up Procedures, 7.6 Main Screen** and **7.10.2 Mode Setting**.

Green mode is the same as On-Line mode, but the difference is that the system will automatically detect the output status (i.e. total load capacity %) to decide which specific power modules should be fully powered on or idle in order to achieve higher efficiency of the UPS. For the Green mode diagram, please see **Figure 3-21**. During Green mode, the UPS's tri-color LED illuminates green and the text 'Green' appears in the upper right corner of the screen.

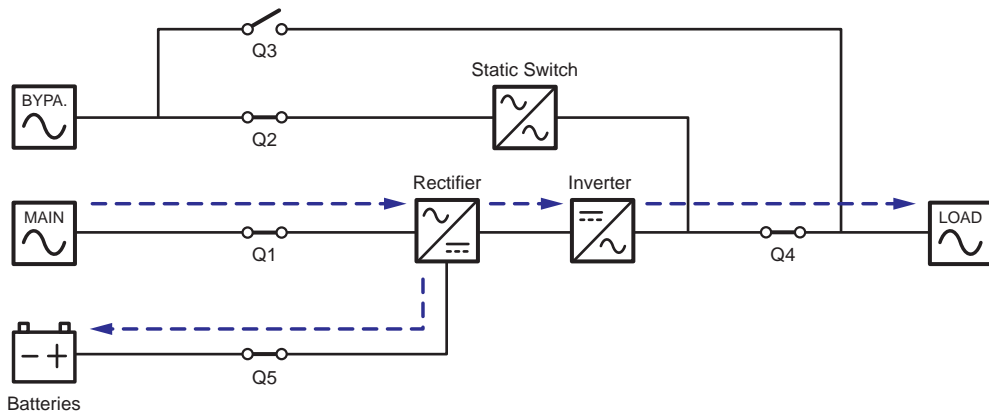

(Figure 3-21: Green Mode Diagram_ Dual Input Single Unit)

3.2.8 On-Line Mode_ Dual Input_ Parallel Units

In On-Line mode (parallel), the total loads will be equally shared by the parallel UPSs. If one of the parallel units fails and its load is less than the total capacity of the remaining parallel units, the failing UPS's output will be switched off and its load will be equally shared by the remaining parallel units. If the failing UPS's load is larger than the total capacity of the remaining parallel units, all UPSs' inverters will turn off and the total loads will be supplied by bypass power. During On-Line mode (parallel), each UPS's tri-color LED illuminates green and each UPS's LCD shows the text 'On-Line' in the upper right corner. Please refer to **Figure 3-22** for the path of electrical power through the parallel UPSs in On-Line mode.

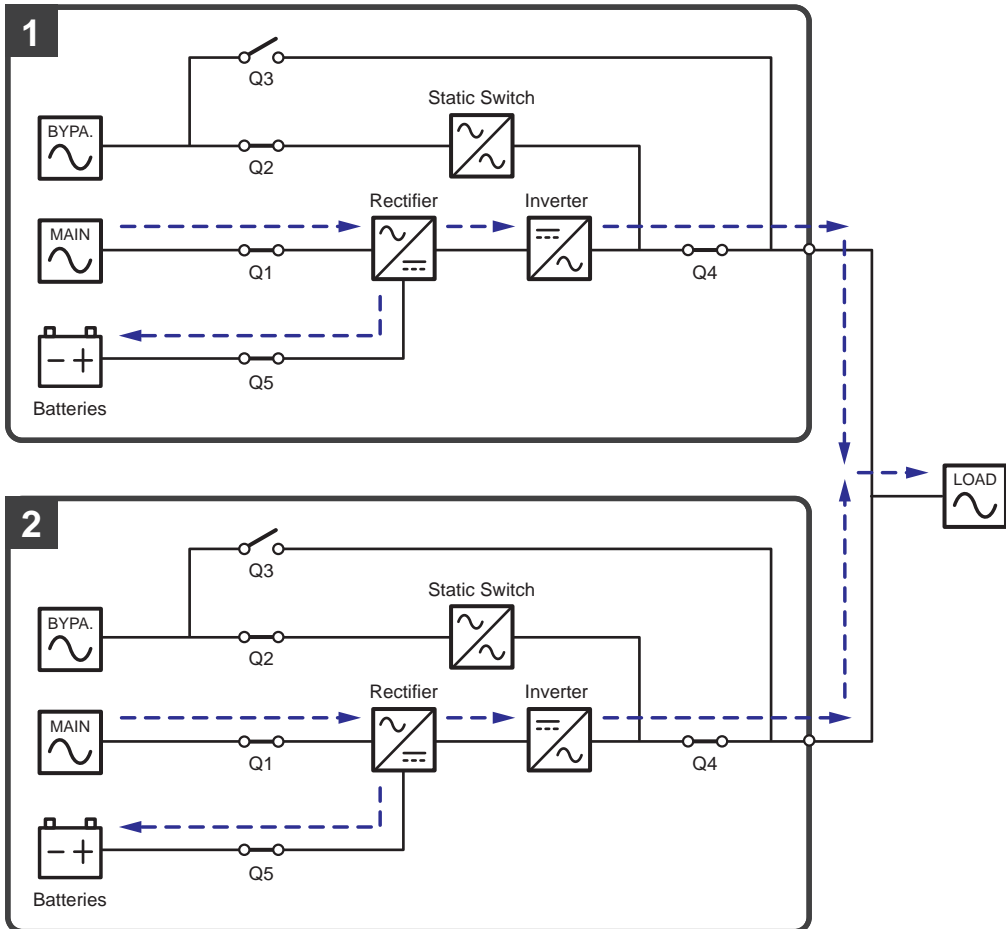

(Figure 3-22: On-Line Mode Diagram_Dual Input Parallel Units)

3.2.9 Battery Mode_ Dual Input_ Parallel Units

If the main AC source is abnormal, for example, when unstable voltage or a power outage occurs, all parallel UPSs will automatically transfer from On-Line mode to Battery mode. During the conversion process, output voltage remains the same. During Battery mode (parallel), each UPS's tri-color LED illuminates yellow and each UPS's LCD shows the text 'Battery' in the upper right corner. Please refer to **Figure 3-23** for the path of electrical power through the parallel UPSs in Battery mode.

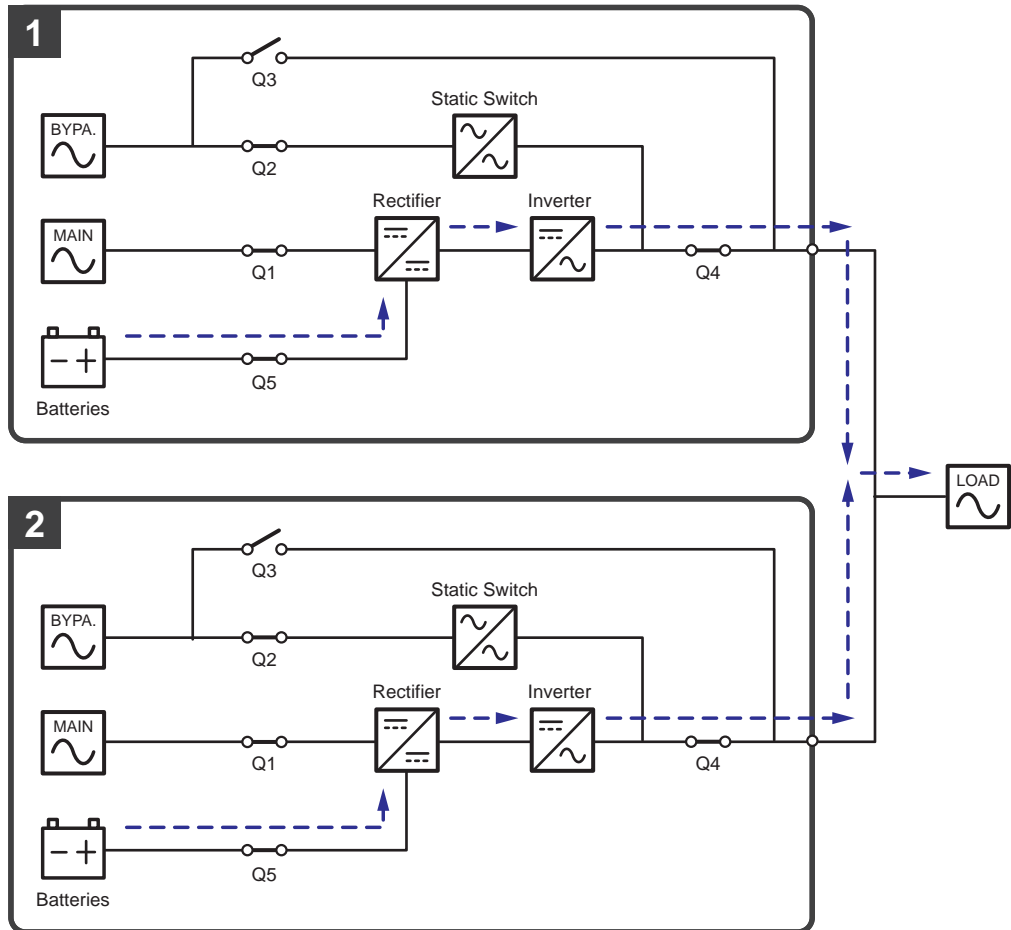

(Figure 3-23: Battery Mode Diagram_ Dual Input Parallel Units)

3.2.10 Bypass Mode_ Dual Input_ Parallel Units

In Bypass mode (parallel), when all inverters encounter abnormal situations such as overload, short circuit, abnormal output voltage or low battery, they will automatically shut themselves down. Meanwhile, if all parallel UPSs detect the bypass AC source is normal, they will automatically switch to Bypass mode to protect the connected critical loads from power interruption. The critical loads will be equally shared by all parallel units. After the abnormalities mentioned above are eliminated, the parallel UPSs will switch back to On-Line mode from Bypass mode. During Bypass mode (parallel), each UPS's tri-color LED illuminates yellow and each UPS's LCD shows the text 'Bypass' in the upper right corner. Please see **Figure 3-24** for the path of electrical power through the parallel UPSs in Bypass mode.

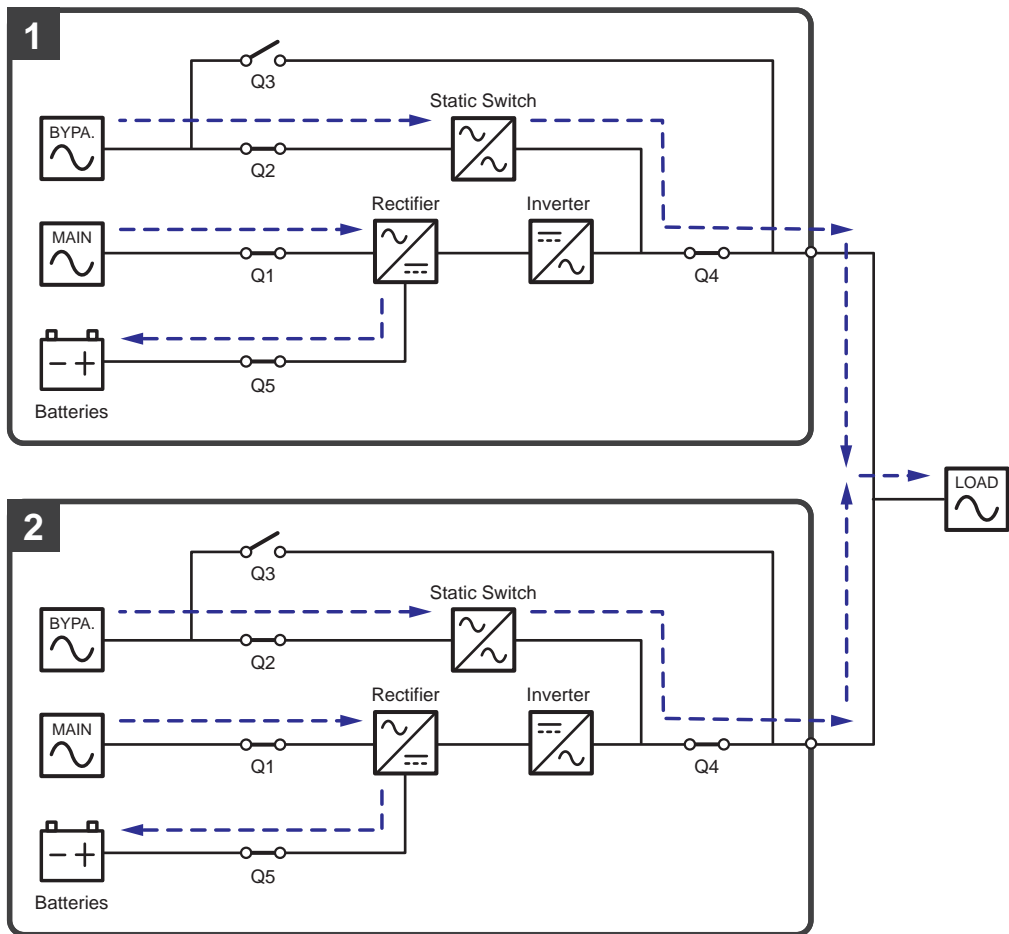

(Figure 3-24: Bypass Mode Diagram_ Dual Input Parallel Units)

3.2.11 Manual Bypass Mode_ Dual Input_ Parallel Units



WARNING:

1. In Manual Bypass mode, make sure that all of the breakers (except each UPS's Manual Bypass Switch (Q3)) are in the **OFF** position before working on any of the parallel UPSs' internal circuits. This avoids electric shock.
2. After the power inside each of the parallel UPSs is completely cut off, there is no high voltage inside all parallel UPSs and maintenance can be performed safely. However, to avoid electric shock, please do not touch the following parts on each parallel UPS: AC Input terminal block, Bypass Input terminal block, UPS Output terminal block, Battery Input terminal block, grounding terminals (see **Figure 5-8 ~ Figure 5-10** for the location of these terminal blocks and terminals) and any copper bars connected to the Manual Bypass Switch (Q3), as they may carry high voltage.
3. During Manual Bypass mode, each parallel UPS's input power is completely cut off and the connected critical loads are not protected.
4. For parallel UPSs, if you want to turn off one of the parallel UPSs for maintenance, please make sure the total connected critical loads will not exceed the remaining parallel units' total capacity.

In Manual Bypass mode (parallel), if one of the parallel UPSs needs maintenance, please first confirm that the bypass AC source and each parallel UPS's STS module are normal. After confirmation, please follow the procedures below to manually switch each of the parallel UPSs to Manual Bypass mode.

- 1 Tap each LCD's ON/ OFF Button () and the '**POWER OFF?**' screen will pop up to ask if you want to power off the UPS's inverter. Please select '**YES**'.
- 2 Turn **ON** each UPS's Manual Bypass Switch (Q3).
- 3 Turn **OFF** each UPS's Bypass Switch (Q2).
- 4 Turn **OFF** each UPS's Input Switch (Q1) and Output Switch (Q4).
- 5 Turn **OFF** each external battery cabinet's breaker (Q5).

In Manual Bypass mode, all power inside the parallel UPSs is completely cut off and maintenance personnel can perform maintenance safely. Power of the connected critical loads will be supplied by manual bypass. During Manual Bypass mode (parallel), all parallel UPSs' tri-color LEDs and LCDs are off. Please see **Figure 3-25** for the path of electrical power through the parallel UPSs in Manual Bypass mode.

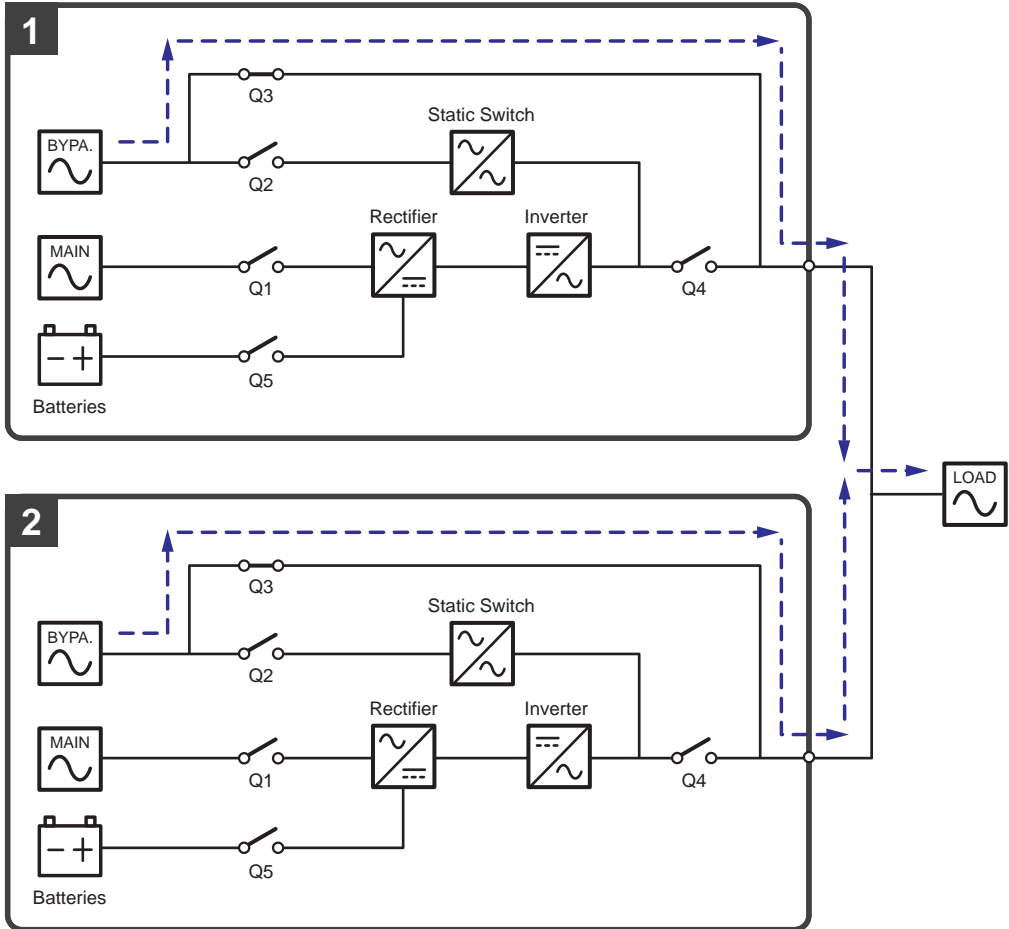

(Figure 3-25: Manual Bypass Mode Diagram_ Dual Input Parallel Units)

3.2.12 ECO Mode_ Dual Input_ Parallel Units

To activate ECO mode, please refer to **6.2.5 ECO Mode Start-up Procedures**, **7.6 Main Screen** and **7.10.2 Mode Setting**.

In ECO mode (parallel), when each parallel UPS's bypass input voltage and frequency are within the range of rating voltage $\pm 10\%$ and rating frequency $\pm 3\text{Hz}$ respectively, each parallel UPS works in Bypass mode; otherwise, each parallel UPS runs in On-Line mode. During ECO mode (parallel), each UPS's tri-color LED illuminates green and each UPS's LCD shows the text 'ECO' in the upper right corner. Please see **Figure 3-26** for the path of electrical power through the parallel UPSs in ECO mode.

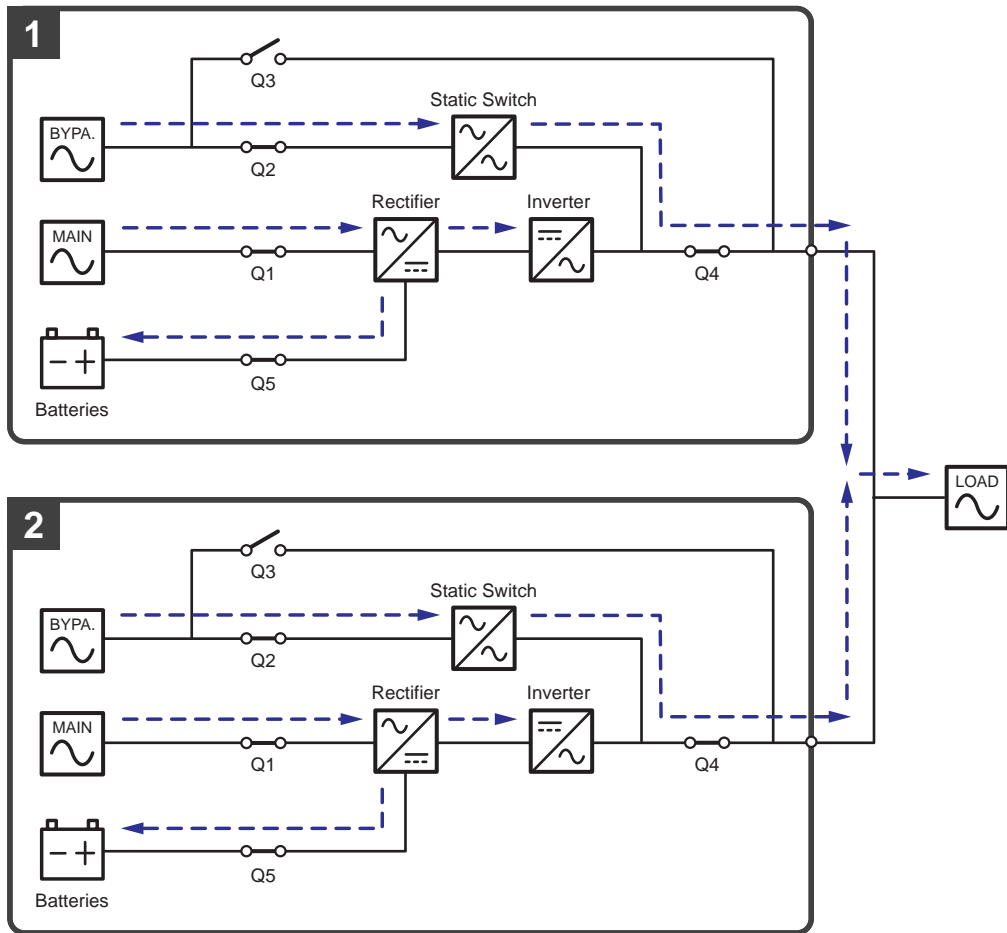

(Figure 3-26: ECO Mode Diagram_ Dual Input Parallel Units)

3.2.13 Green Mode_ Dual Input_ Parallel Units

To activate Green mode, please refer to **6.2.7 Green Mode Start-up Procedures**, **7.6 Main Screen** and **7.10.2 Mode Setting**.

For parallel application, Green mode is the same as On-Line mode, but the difference is that each parallel UPS's system will automatically detect its own output status (i.e. total load capacity %) to decide which specific power modules should be fully powered on or idle in order to achieve higher efficiency of the UPS. During Green mode (parallel), each UPS's tri-color LED illuminates green and each UPS's LCD shows the text 'Green' in the upper right corner. Please see **Figure 3-27** for the path of electrical power through the parallel UPSs in Green mode.

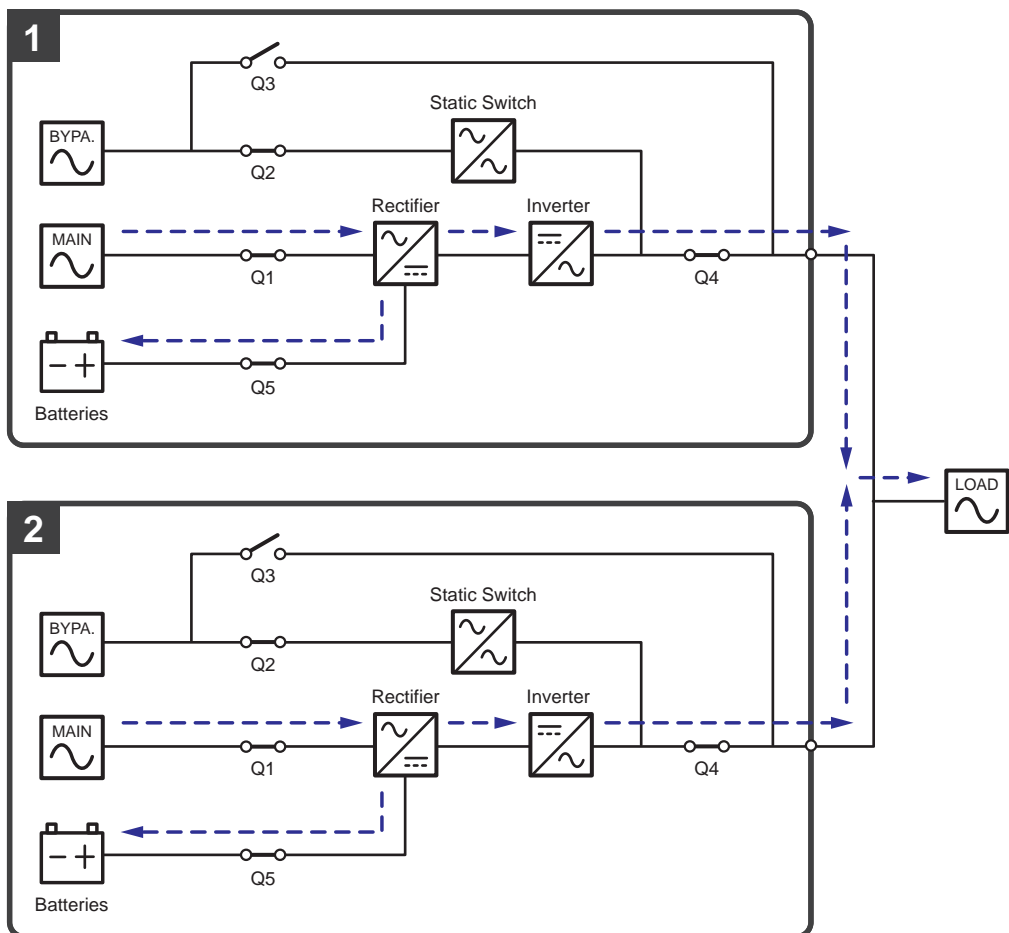

(Figure 3-27: Green Mode Diagram_ Dual Input Parallel Units)

3.3 Hot Standby Redundancy (Only for Dual Input & At Least Two UPSs)

To provide customers more application choices, the UPS with dual-input configurations can have a hot standby redundancy function. If you use two UPSs and wish them to work in hot standby redundancy mode, please connect the output of UPS1 to the bypass input of UPS 2. Please see **Figure 3-28**.

For more information about the hot standby redundancy application, please contact service personnel.

In normal condition, it is the UPS 2 inverter that supplies power to the critical loads. Both UPS 1 & UPS 2 tri-color LEDs illuminate green.

When the UPS 2 inverter becomes abnormal, the UPS 2 will automatically transfer to bypass mode and the UPS 1 inverter will supply power to the critical loads. Under such circumstances, the UPS 1 tri-color LED illuminates green and the UPS 2 tri-color LED illuminates yellow.

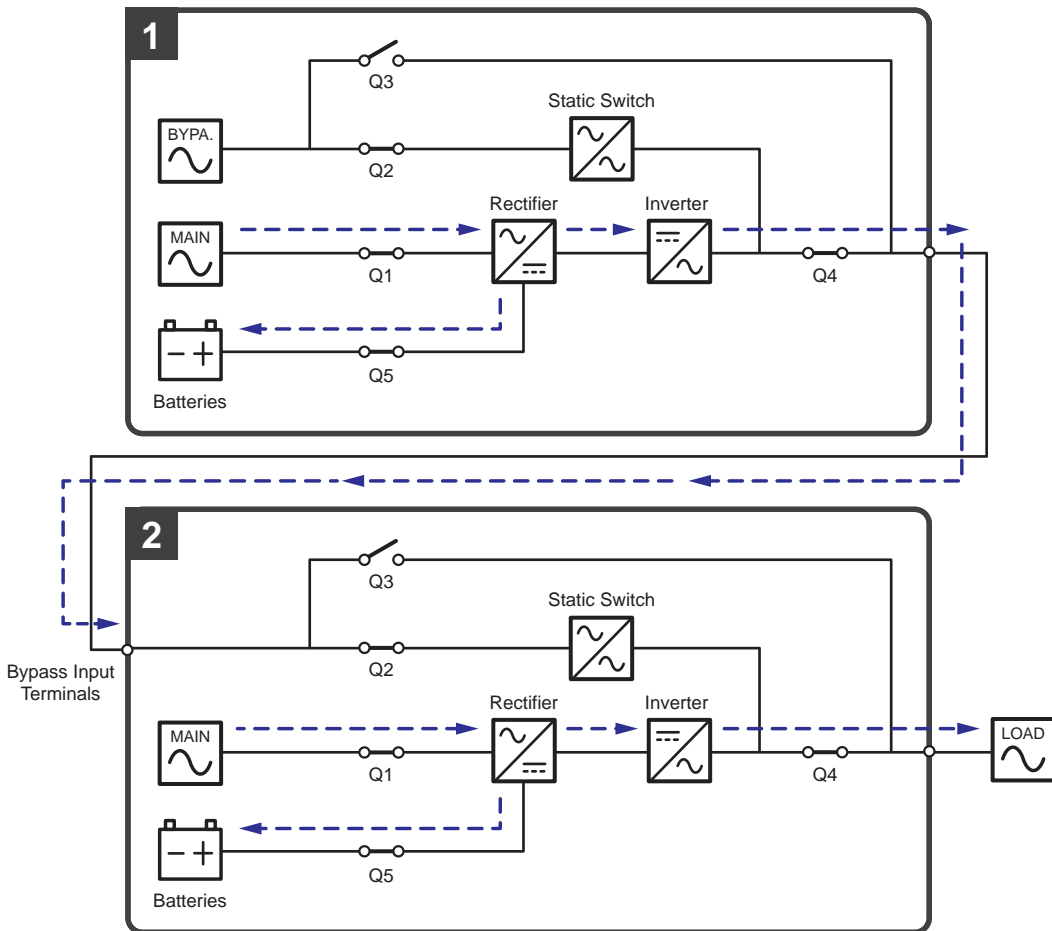

(Figure 3-28: Hot Standby Redundancy Diagram (only for Dual Input & at Least Two UPSs))

3.4 Common Battery (Only for Parallel UPSs Connecting to the Same External Battery Cabinet(s))



NOTE:

1. The 'common battery' information in this chapter is only applicable to the UPS using lead-acid batteries. If you need information about the lithium-ion batteries, please refer to the user manual of the lithium-ion batteries or contact Delta customer service.
2. Whether you use the lead-acid batteries or the lithium-ion batteries, please contact Delta service personnel for any battery/ battery cabinet's setup and configurations.

To save on your costs and installation space, the parallel UPSs can share their connected external battery cabinet(s). For common battery application, please install a protective device between each parallel UPS and its connected external battery cabinet(s). For relevant information about the protective device, please refer to **5.6 External Battery Cabinet Connection Warnings**. Please see **Figure 3-29** for two parallel UPSs sharing one external battery cabinet as an example.

If the parallel UPSs share the external battery cabinet(s), you should use the LCD to set up relevant parameters such as '**Battery Type**', '**Capacity**', '**Battery Strings**', '**Float Charge Voltage**', '**Equalized Charge Voltage**'^{*1}, '**Charge Current (Max)**', etc. For more information, please refer to **7.10.4 Battery & Charging Setting**.



NOTE:

1. For common battery application, please use the LCD to set each UPS's float charge voltage (default: 272V) the same, each UPS's equalized charge voltage^{*1} (if applicable, default: 280V) the same, and each UPS's battery strings and charge current (Max) even. For example:
 - A. When (1) two UPSs are paralleled and share one external battery cabinet, (2) the lead-acid batteries are used, (3) the battery capacity is 200AH, (4) there are a total of 4 battery strings, and (5) the charge current (Max) is 80A, please use the LCD to set each UPS's '**Battery Type**' as '**VRLA**', '**Capacity**' as 200AH, '**Battery Strings**' as 2, and '**Charge Current (Max)**' as 40A.
 - B. When (1) three UPSs are paralleled and share one external battery cabinet, (2) the lead-acid batteries are used, (3) the battery capacity is 300AH, (4) there are a total of 3 battery strings, and (5) the charge current (Max) is 90A, please use the LCD to set each UPS's '**Battery Type**' as '**VRLA**', '**Capacity**' as 300AH, '**Battery Strings**' as 1, and '**Charge Current (Max)**' as 30A.
2. ^{*1} The item '**Equalized Charge Voltage**' mentioned above will change into '**Restored Voltage**' if you use the Delta lithium-ion batteries with the optional multifunctional communication card (MFC) being installed in the SMART slot shown in **Figure 4-13**. For relevant information, please refer to **7.10.4 Battery & Charging Setting**.

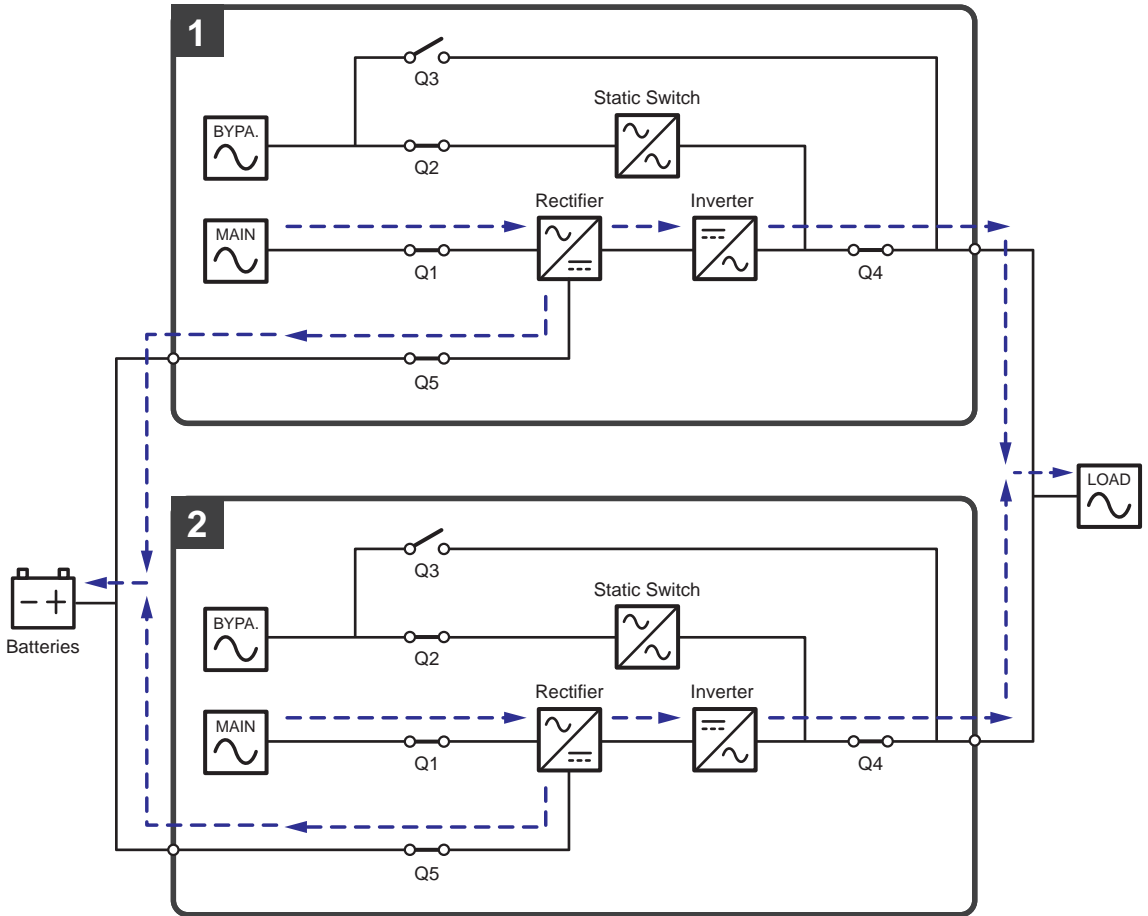

(Figure 3-29: Common Battery Diagram_ only for Parallel UPSs Connecting to the Same External Battery Cabinet(s))

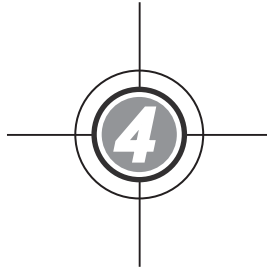

Communication Interfaces

- 4.1 Communication Interfaces (I): on the Front of the UPS with Two Front Doors Open
- 4.2 Communication Interfaces (II): at the Rear of the Touch Panel

The communication interfaces are hot swappable and located at two different places. One is on the front of the UPS with two front doors open and the other is at the rear of the touch panel. Please see **Figure 4-1**.

(Internal View with Two Front Doors Open)

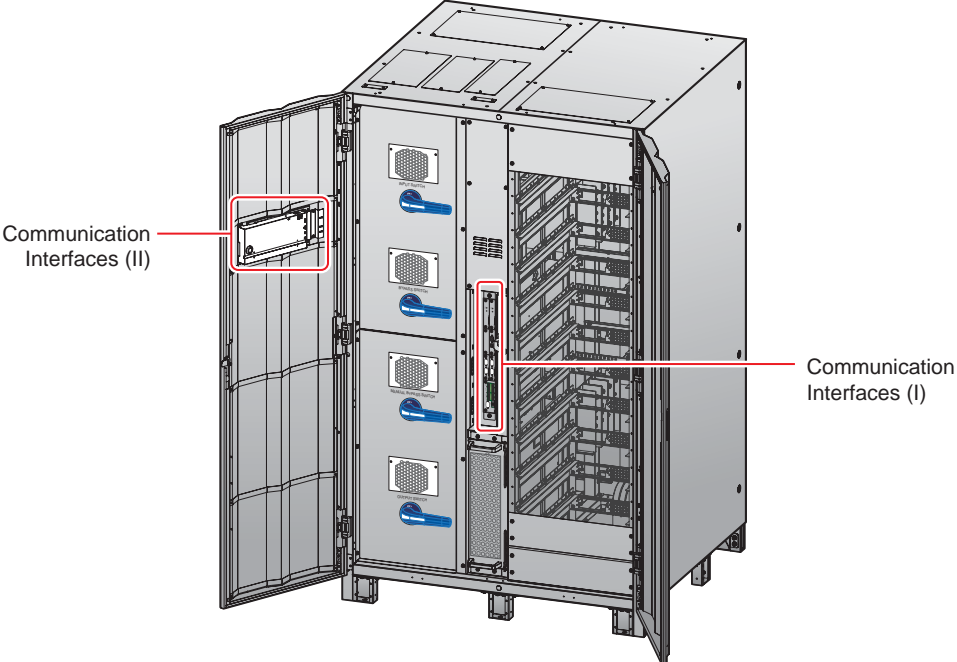

(Figure 4-1: Location of the Communication Interfaces)

4.1 Communication Interfaces (I): on the Front of the UPS with Two Front Doors Open

The following communication interfaces are located on the front of the UPS with two front doors open. Please refer to **Figure 4-2** and the table below.

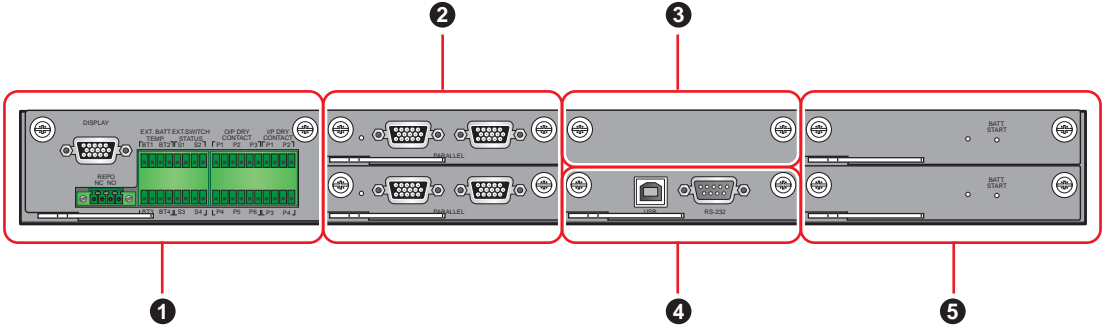

(Figure 4-2: Communication Interfaces (I)_ on the Front of the UPS with Two Front Doors Open)

No.	Item	Q'ty	Description
①	Dry Contact Card	1 PC	Includes a display port, REPO dry contacts, external battery temperature detection, external switch/breaker status dry contacts, output dry contacts and input dry contacts.
②	Parallel Communication Card	2 PCS	Each card includes two parallel ports and one LED indicator.
③	SMART Slot	1 PC	<ol style="list-style-type: none"> 1. You can install the optional Relay I/O card in the slot for dry contact expansion. 2. If you use the Delta lithium-ion batteries, you must purchase the optional multifunctional communication card (MFC) and install it in the SMART slot to monitor the status and information of the Delta lithium-ion batteries. For relevant information, please refer to 7.9.6 Battery Status, 7.10.4 Battery & Charging Setting and 7.10.7 General Setting. If you have any questions, please contact Delta customer service.
④	System Control Card	1 PC	Includes a USB port and an RS-232 port.
⑤	Auxiliary Power Card	2 PCS	Each card includes a LED indicator and a battery start button.

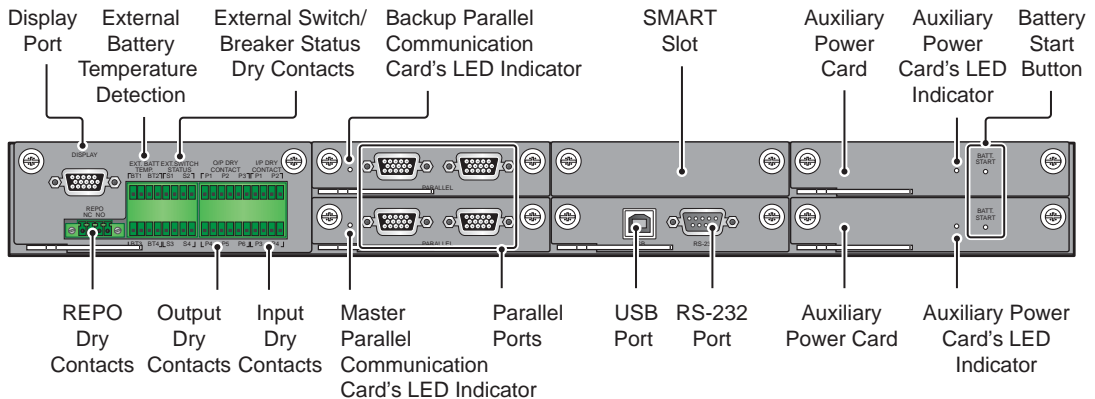

(Figure 4-3: Functions of the Communication Interfaces)

4.1.1 Display Port

Before shipment, the display port has been connected to the 10" touch panel with the designated cable in Delta factory.

4.1.2 REPO Dry Contacts

The REPO dry contacts provide you with quick and convenient interfaces to shut down the UPS safely when an emergency occurs. Connect the REPO dry contacts to a user-supplied switch and you can remotely shut down the UPS. The REPO dry contacts provide normally open (NO) and normally closed (NC) these two options for use.

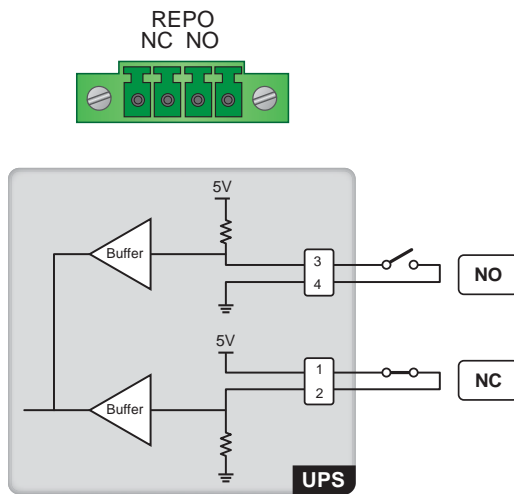

(Figure 4-4: REPO Dry Contacts & Schematic)



NOTE:

If you want to enable the normally closed (NC) function, please take out the dry contact card (see **Figure 4-5**) and remove its Jump CNR3 (see **Figure 4-6**) before you turn on the UPS.

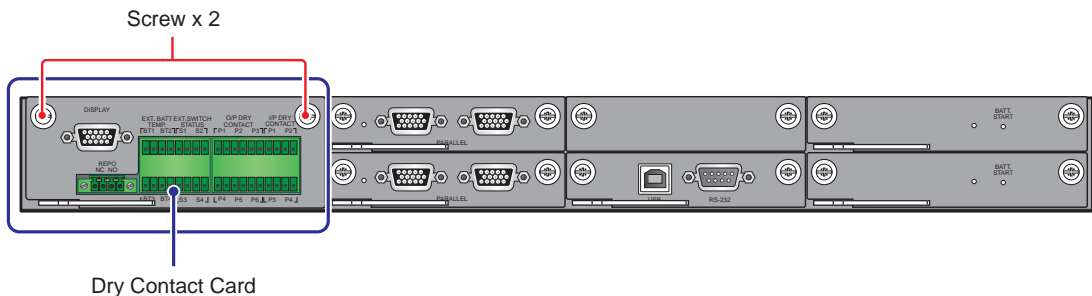

(Figure 4-5: Location of the Dry Contact Card)

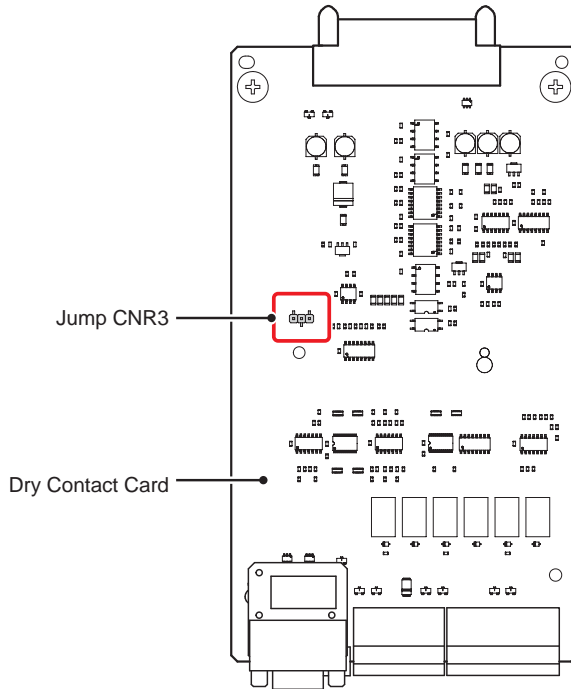

(Figure 4-6: Location of the Jump CNR3)

4.1.3 External Battery Temperature Detection

You can use the external battery temperature detection (BT1, BT2, BT3 and BT4) to detect a maximum of four external battery cabinets' temperature. You need to purchase the battery cabinet temperature sensor cable (optional).

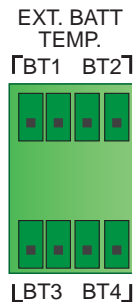

(Figure 4-7: External Battery Temperature Detection & Schematic)

4.1.4 External Switch/ Breaker Status Dry Contacts

There are four sets of external switch/ breaker status dry contacts (S1, S2, S3 and S4), which can be used to respectively detect the status of input, bypass, output and manual bypass switches or breakers. Please follow the table below to connect the dry contacts to normally open (NO) or normally closed (NC) devices.

Type	Connection
Dry Contact_ S1	Normally closed (NC) device
Dry Contact_ S2	Normally closed (NC) device
Dry Contact_ S3	Normally closed (NC) device
Dry Contact_ S4	Normally open (NO) device

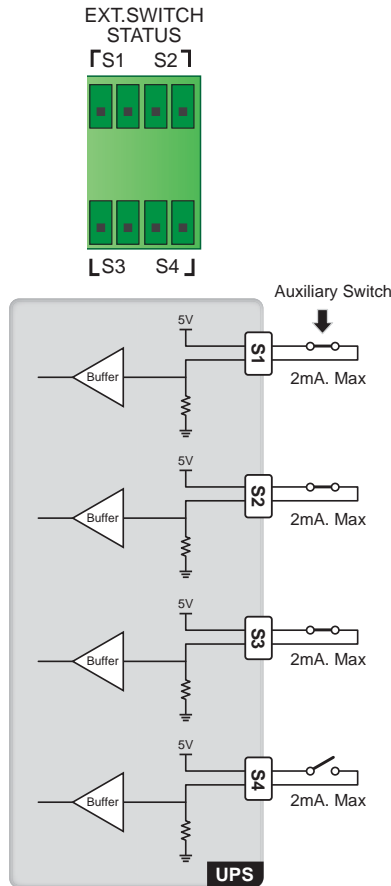

(Figure 4-8: External Switch/ Breaker Status Dry Contacts & Schematic)

No.	Event	Description
1	External input switch or breaker detection.	Detect the external input switch or breaker's status (default: S1).
2	External bypass switch or breaker detection.	Detect the external bypass switch or breaker's status (default: S2).
3	External output switch or breaker detection.	Detect the external output switch or breaker's status (default: S3).
4	External manual bypass switch or breaker detection.	Detect the external manual bypass switch or breaker's status (default: S4).

4.1.5 Output Dry Contacts

There are six sets of programmable output dry contacts (see **Figure 4-9**). Please use the touch panel to set each dry contact as normally open (NO) or normally closed (NC). Each dry contact can be assigned with a specific event. Six out of twenty-one events can be assigned according to your applications. For the twenty-one events, please refer to the table below. To learn how to set up, please contact your local dealer and refer to **7.10.6 Dry Contact Setting**.



NOTE:

Since the output dry contacts belong to the secondary circuit, the voltage of each dry contact's connected device should not exceed 60Vdc/ 42Vac to avoid electric shock and insufficient insulation.

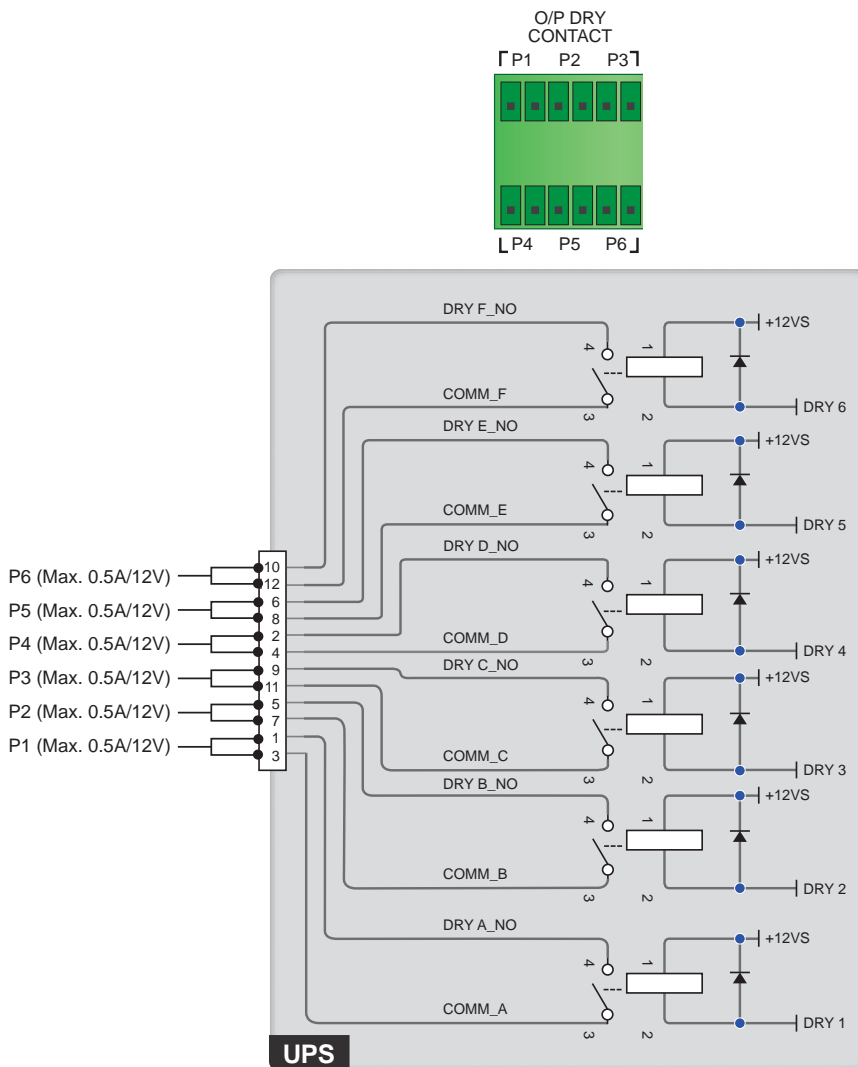

(Figure 4-9: Output Dry Contacts & Schematic)

No.	Event	Description
1	None	No set-up.
2	Load On Inverter	The UPS works in online mode.
3	Load On Bypass	The UPS works in bypass mode.
4	Load On Battery	When the main AC source fails, the batteries supply power to the critical loads.
5	Battery Low	When the UPS runs in battery mode, battery voltage is lower than the setup limit (default: 220Vdc).
6	Bypass Input Abnormal	The bypass voltage, frequency or phase sequence is abnormal.
7	Battery Test Fail	During the battery test, the battery voltage is out of the setup limit.
8	Internal Comm. Fail	The #n power module's internal communication is abnormal.
9	External Parallel Comm. Fail (For parallel application only)	In parallel mode, parallel communication is abnormal.
10	Output Overload	The UPS is overloaded or the UPS shuts down to let the bypass supply power to the critical loads.
11	EPO Activated	The EPO button is pressed to urgently power off the UPS.
12	Load On Manual Bypass	The Manual Bypass Switch (Q3) is turned on and the UPS transfers to manual bypass mode.
13	Battery Over Temperature	The external battery cabinet's temperature is too high.
14	Output Voltage Abnormal	The output voltage is too high or too low.
15	Battery Need Replacement	The battery replacement date is due.
16	Bypass Over Temperature	The bypass static switch temperature is too high.
17	Bypass Static Switch Fault	The bypass static switch has an open/ short issue.
18	UPS Over Temperature	The UPS temperature is too high.
19	Battery Breaker Shunt Trip	When the EPO button is pressed, the UPS will send a signal to the connected external shunt trip device to cut off the battery power.
20	Backfeed Protection	When the UPS's bypass SCR has an open/ short issue, the UPS will send a signal to the connected external shunt trip device to cut off the backfeed voltage.
21	General Alarm	When any UPS alarm occurs, the UPS will send an I/O signal.

4.1.6 Input Dry Contacts

There are four sets of programmable input dry contacts (see **Figure 4-10**). The input dry contacts allow the UPS to receive external signals from peripheral devices and let the UPS response accordingly. Please use the touch panel to set each dry contact as normally open (NO) or normally closed (NC). Each input dry contact can be assigned with a specific event. There are six events can be assigned according to your applications. For information about the six events, please refer to the table below. To learn how to set up, please contact your local dealer and refer to **7.10.6 Dry Contact Set**.

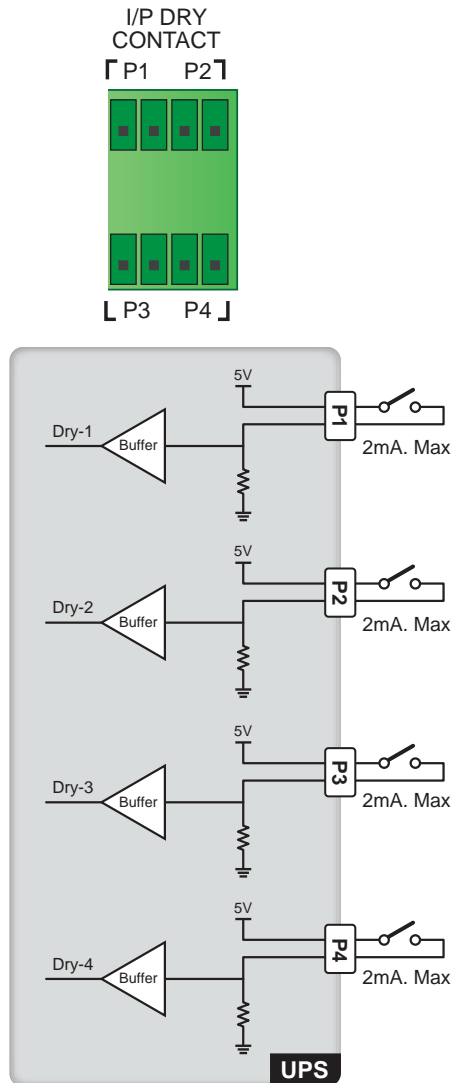

(Figure 4-10: Input Dry Contacts & Schematic)

No.	Event	Description
1	None	No set-up.
2	Generator Status	Generator status detection.
3	Battery Ground Fail	Battery leakage detection.
4	External Battery Breaker Detection	Status detection of the external battery cabinet's breaker or switch.
5	Charger Off (Positive)* ¹	Turn off the charger (positive).
6	Charger Off (Negative)* ¹	Turn off the charger (negative).



NOTE:

*¹ If you use non-Delta lithium-ion batteries, you must set up **Charger Off (Positive)** and **Charger Off (Negative)** these two items. Please refer to **7.10.4 Battery & Charging Setting** and **7.10.6 Dry Contact Setting** to perform relevant setup. If you have any questions, please contact Delta customer service.

4.1.7 Parallel Communication Cards

The UPS has two parallel communication cards, which are master parallel communication card and backup parallel communication card. Each card has one LED indicator and two parallel ports. Please see **Figure 4-11** and **Figure 4-12** for relevant location.

If both cards work normally, the master parallel communication card's LED indicator will illuminate green and the backup parallel communication card's LED indicator will illuminate yellow.

If one card works normally and the other works abnormally, the normal card's LED indicator will illuminate green and the abnormal card's LED indicator will illuminate red.

During initialization process, both cards' LED indicators flash yellow.

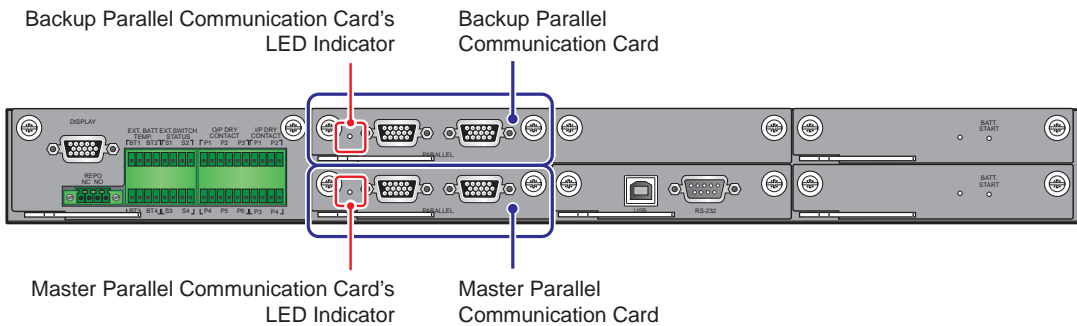

(Figure 4-11: Location of the Parallel Communication Cards)

4.1.8 Parallel Ports

The parallel ports (see **Figure 4-12**) are used to connect parallel UPSs to increase the system capacity and redundancy. With the provided parallel cable, up to eight UPS units with the same capacity, voltage, frequency, version and serial No. can be paralleled. For version and serial No. information, please refer to **7.11.7 Version & S/N**. Please only use the provided parallel cable to parallel the UPS units. Otherwise, parallel functions will fail. To enhance parallel reliability, please adopt Daisy Chain method (see **Figure 5-14 & Figure 5-16**) to execute parallel configurations.



WARNING:

One parallel cable is provided in each UPS's accessory package. Using non-Delta parallel cables to parallel the UPSs may cause failure, malfunctions and accidents.

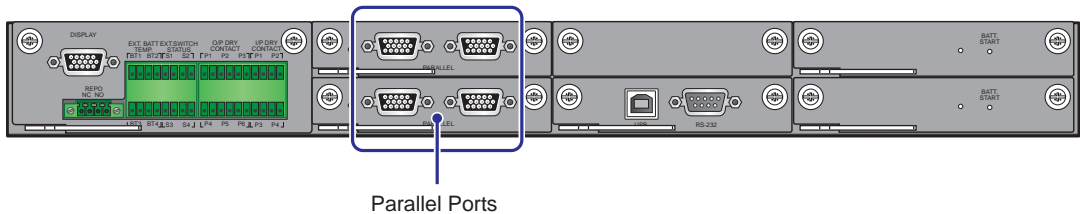

(Figure 4-12: Location of the Parallel Ports)

4.1.9 SMART Slot

1. You can install the optional Relay I/O card (for dry contact expansion) into the SMART slot shown in **Figure 4-13**. For relevant installation and application information, please contact Delta customer service.
2. If you use the Delta lithium-ion batteries (please refer to the Delta P/N shown below), you must purchase the optional multifunctional communication card (MFC) and install it in the SMART slot shown in **Figure 4-13** to monitor the status and information of the Delta lithium-ion batteries. For relevant information, please refer to **7.9.6 Battery Status**, **7.10.4 Battery & Charging Setting** and **7.10.7 General Setting**. If you have any questions, please contact Delta customer service.

Delta Lithium-ion Batteries	Delta P/N
UPS BTY RACK 31.0KWH, Master (60Ah)	UBR120B14001A00
UPS BTY RACK 31.0KWH, Slave (60Ah)	UBR120B14001A01
UPS BTY RACK 62.1KWH, Master (60Ah)	UBR240B14002A00
UPS BTY RACK 62.1KWH, Slave (60Ah)	UBR240B14002A01

Delta Lithium-ion Batteries



Please use the Ethernet cable*¹ to connect the MFC's parallel ports. The Ethernet cable routing is the same as the UPS parallel cable routing (see **Figure 5-14-1**).



NOTE:

*¹ One Ethernet cable is provided in each package of the optional multi-functional communication card (MFC).

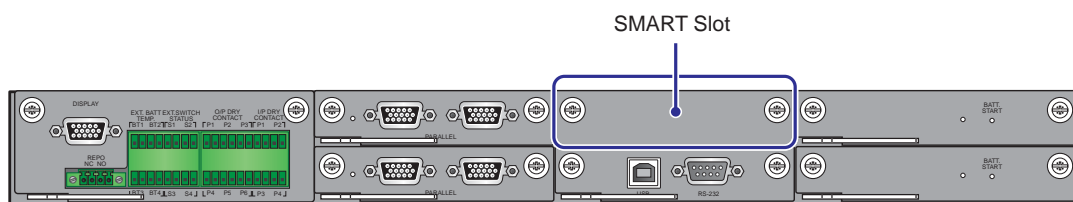

(Figure 4-13: Location of the SMART Slot)

4.1.10 USB Port & RS-232 Port

Only service personnel can use an RS-232 cable (provided) or a USB cable (provided) to connect a computer to the UPS's RS-232 port or USB port to (1) upgrade the firmware of the UPS, power modules, system control card, parallel communication cards and optional multifunctional communication card (MFC) and (2) download event logs.



NOTE:

Do not use the RS-232 port and the USB port at the same time.

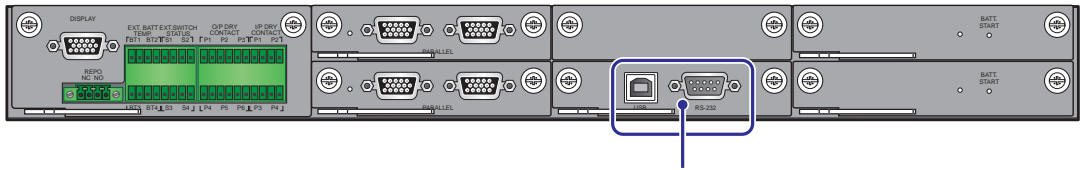

USB Port & RS-232 Port

(Figure 4-14: Location of the USB Port & RS-232 Port)

4.1.11 Auxiliary Power Cards

The UPS has two auxiliary power cards. Each card has one LED indicator. Please see **Figure 4-15** for their location.

If the auxiliary power card works normally, its LED indicator will illuminate green. If the auxiliary power card is off or abnormal, its LED indicator will be off.



WARNING:

When replacing, remove only one auxiliary power card at a time to avoid power interruption.

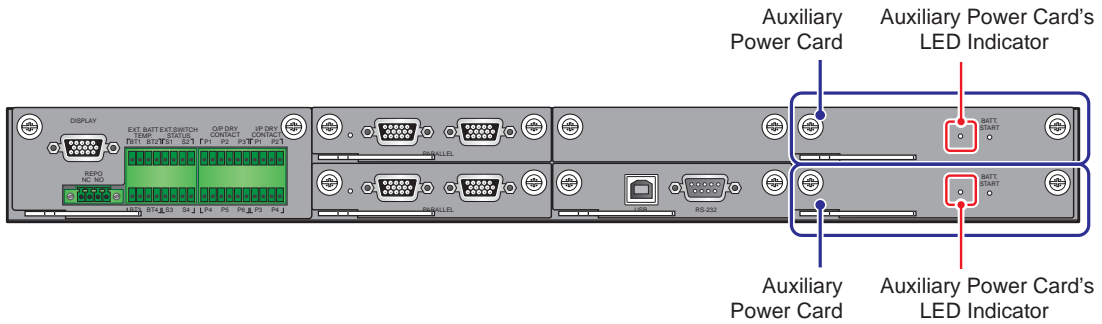

(Figure 4-15: Location of the Auxiliary Power Cards)

4.1.12 Battery Start Buttons

Please refer to **Figure 4-16** for the location of battery start buttons. For the battery start buttons' relevant operation information, please refer to **6.2.2 Battery Mode Start-up Procedures**.

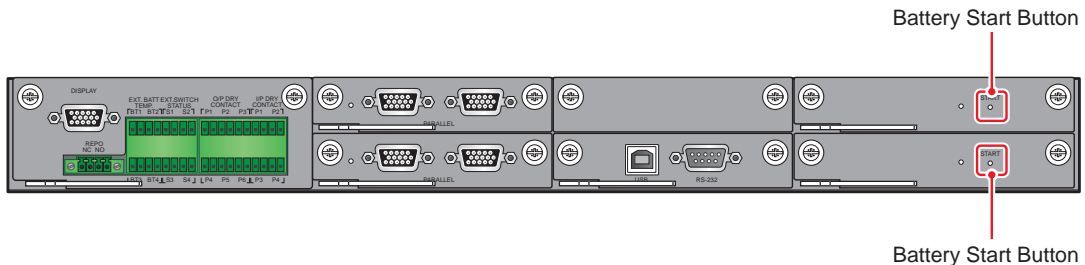

(Figure 4-16: Location of the Battery Start Buttons)



4.2 Communication Interfaces (II): at the Rear of the Touch Panel

The following communication interfaces are located at the rear of the touch panel. Please refer to **Figure 4-17** and the table below.

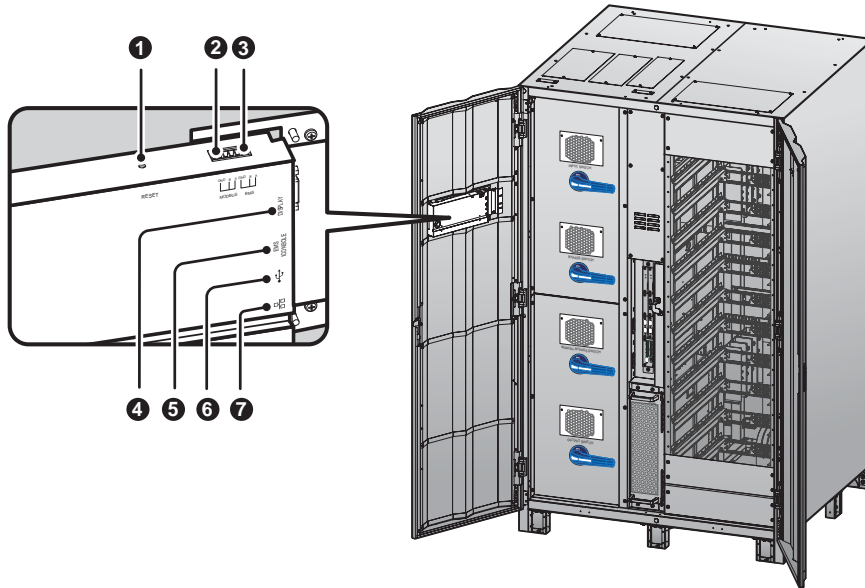
(Internal View with Two Front Doors Open)



(Figure 4-17: Communication Interfaces (II)_ at the Rear of the Touch Panel)

No.	Item	Function
①	RESET	Press the RESET button once to restart the LCD.
②	MODBUS (RS-485 Port)	1. Provides MODBUS RTU communication service. 2. Connects to a user-supplied monitoring system.
③	BMS	Connects to the Delta battery management system (optional). The BMS function is only applicable to lead-acid batteries.
④	DISPLAY	Before shipment, the DISPLAY port has been connected.
⑤	EMS/ CONSOLE	Connects to a user-supplied environmental monitoring system or Delta EnviroProbe 1000 (optional).
⑥	 (USB Port x 2)	There are two USB ports. Connects a user-supplied USB flash drive to any of the USB ports to (1) upgrade the UPS and LCD's firmware and (2) download event logs.
⑦	 (Network Port)	1. Provides network communication service (including SNMP, MODBUS TCP, HTTP, HTTPS, etc.). 2. Connects to a user-supplied monitoring system.

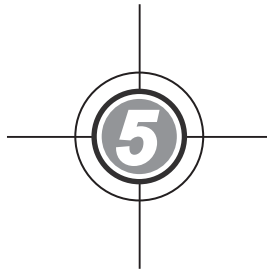

Installation and Wiring

- 5.1 Before Installation and Wiring
- 5.2 Installation Environment
- 5.3 UPS Transportation
- 5.4 UPS Installation
- 5.5 Wiring
- 5.6 External Battery Cabinet Connection Warnings
- 5.7 STS Module
- 5.8 Power Module (Optional)

5.1 Before Installation and Wiring

- Please read this user manual thoroughly before installation, wiring and operation. Only authorized Delta engineers or service personnel can perform installation, wiring, panel & cover removal, maintenance and operation. If you want to execute any action mentioned above by yourself, the action must be under the supervision of authorized Delta engineers or service personnel. If you use a forklift or other equipment to move the UPS, please make sure its load bearing is sufficient. Please refer to **Table 5-1**.
- The UPS must be connected with at least one external battery cabinet (user-supplied, handled and configured by Delta service personnel). Please refer to **5.6 External Battery Cabinet Connection Warnings** for relevant information.

5.2 Installation Environment

- Install the UPS indoors. Do not place it outdoors.
- Make sure that transportation routes (e.g. corridors, door gates, elevators, etc.) and installation area can accommodate and bear the weight of the UPS, external battery cabinet(s), and handling equipment. Please refer to **Table 5-1** for floor weight loading information.

Table 5-1: UPS Floor Weight Loading Table

DPH Series UPS_ 200/ 300/ 400/ 500/ 600kVA					
UPS Net Weight (without Power Modules): 605 kg (1333.8 lb)					
UPS Weight Loading (without Power Modules): 458.3 kg/m² (93.9 lb/ft²)					
UPS Capacity	200kVA/ 200kW	300kVA/ 300kW	400kVA/ 400kW	500kVA/ 500kW	600kVA/ 600kW
Power Module Q'ty	4	6	8	10	12
Weight	753 kg (1660.1 lb)	828 kg (1825.4 lb)	902 kg (1988.6 lb)	976 kg (2151.7 lb)	1050 kg (2314.9 lb)
Floor Weight Loading	570.5 kg/m ² (116.8 lb/ft ²)	627.3 kg/m ² (128.5 lb/ft ²)	683.3 kg/m ² (140.0 lb/ft ²)	739.4 kg/m ² (151.4 lb/ft ²)	795.5 kg/m ² (162.9 lb/ft ²)

- The UPS allows cable entry from the top or bottom. Please leave adequate space on the top or at the bottom of the UPS to allow cable entry.
- Ensure that the installation area is big enough for maintenance and ventilation. Since the UPS adopts the design of air inlet at the front and air outlet at the rear (see **Figure 5-1**) and the external battery cabinet must be placed next to the UPS, we suggest that you:

1. Keep a distance of 1000 mm (39.4") from the front of the UPS for maintenance and ventilation.
2. Keep a distance of at least 350 mm (13.8") from the rear of the UPS for ventilation, or at least 500 mm (19.7") for maintenance.
3. Keep a distance of 500 mm (19.7") from the top of the UPS for maintenance, wiring and ventilation.

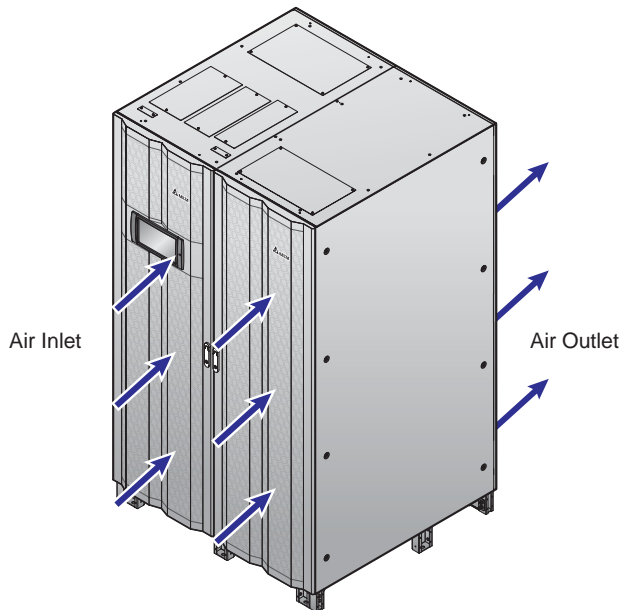

(Figure 5-1: UPS Air Inlet & Outlet Direction)

- Keep the installation area clean. Please note that wiring routes must be hermetic to prevent possible damage from rodents.
- Keep the installation area's temperature around 25°C (77°F) and humidity within 95%. The highest operating altitude is 1000 meters (3280 ft) above sea level.
- For safety concerns, we suggest that you:
 1. Equip surroundings of the installation area with CO₂ or dry powder fire extinguishers.
 2. Install the UPS in an environment where fireproof materials are used to construct the walls, floors and ceilings.
 3. Install the UPS on a floor that is made of noncombustible materials.
- Do not allow unauthorized personnel to enter the installation area and assign specified personnel to keep the UPS key.



WARNING:

Do not use air conditioners or similar equipment to blow into the rear of the UPS and hinder ventilation.

5.3 UPS Transportation

At the bottom of the UPS, there are eight stands which have been firmly fixed on the pallet before shipment. Before unloading the UPS from the pallet, please use a #17 combination wrench and a socket wrench to remove the eight bolts and eight screws from the eight stands (see **Figure 5-2**). After that, use appropriate handling equipment (e.g. forklift) to carefully move the UPS from its pallet to the ground.

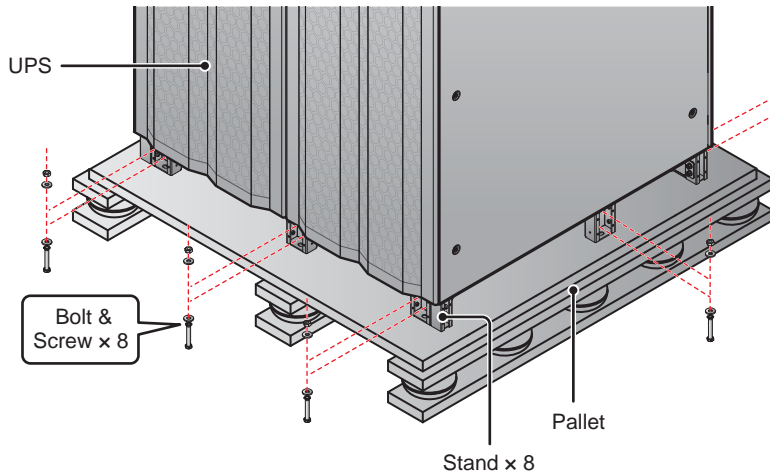

(Figure 5-2: Location of the Stands, Bolts & Screws)

5.4 UPS Installation



NOTE:

Please use appropriate equipment (e.g. forklift) to move the UPS.

Please follow the steps below:

- 1 Before installing the UPS in a designated installation area, please double check whether the area's floor weight loading is sufficient to bear the UPS, external battery cabinet(s) and handling equipment (e.g. forklift) to avoid accidents. For UPS floor weight loading information, please refer to **Table 5-1**.
- 2 After the UPS is moved to the designated installation area, please check that the UPS can stand on the ground stably and levelly without any tipping.
- 3 At the bottom of the UPS, there are eight stands, three at the front, three at the rear, and one at each side. Please firmly fix the eight stands on the ground to avoid UPS movement. A M10 expansion screw (provided by qualified service personnel) for each stand is required. For how to fix the UPS stands on the ground, please refer to **Figure 5-3**.

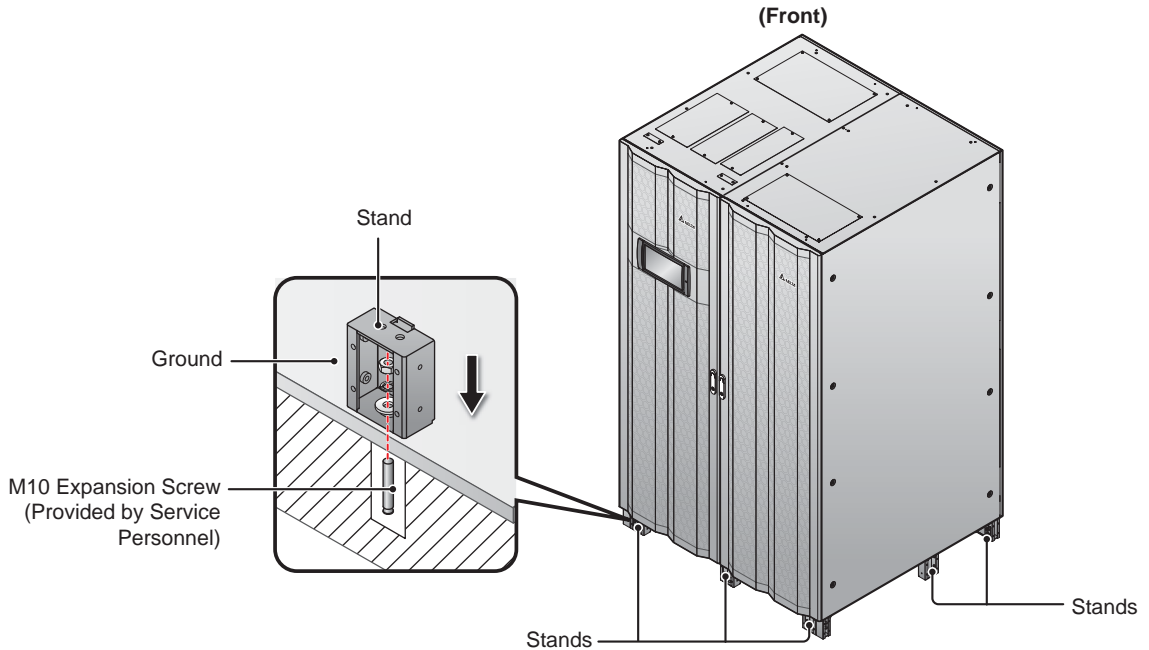

(Figure 5-3: Fix the UPS Stands on the Ground)



WARNING:

If you don't fix the UPS stands on the ground, the UPS might topple over. For safety concerns, please fix the UPS stands on the ground.

- 4 Follow **5.5 Wiring** to perform wiring procedures.
- 5 Follow **5.6 External Battery Cabinet Connection Warnings** to connect the external battery cabinet(s).
- 6 Follow **5.8 Power Module (Optional)** to install the power modules.
- 7 After routing the cables and verifying cable connections, seal or cover the gaps between the cables and the cabinet to avoid foreign materials falling into the UPS. After that, reinstall the removed panels and close the UPS's two front doors if necessary.

5.5 Wiring

5.5.1 Pre-wiring Warnings



NOTE:

1. Before wiring, please ensure that you have followed **5.4 UPS Installation** to fix the UPS in the designated installation area firmly.
 2. Before wiring, please read **5.5 Wiring** thoroughly.
 3. Only authorized Delta engineers or service personnel can perform installation, wiring, panel & cover removal, maintenance and operation. If you want to execute any action mentioned above by yourself, the action must be under the supervision of authorized Delta engineers or service personnel.
 4. During wiring procedures, please protect the UPS from foreign materials falling into the cabinets.
- Before wiring or making any electrical connection, make sure that the power supplied to the input and output of the UPS is completely cut off.
 - The UPS allows cable entry from the top or bottom. Please leave adequate space on the top or at the bottom of the UPS to allow cable entry.
 - Check that the size, diameter, phase, polarity are correct for each cable that needs connecting to the UPS and external battery cabinet(s). Please refer to **Table 5-2**.



NOTE:

Table 5-2 is based on (1) default input/ output voltage: 220V, (2) default battery Q'ty: 40 PCS and (3) default charge current per power module: 5A. For other conditions different from **Table 5-2**, please contact Delta service personnel for relevant values.

Table 5-2: Specifications of Input/ Output/ Battery Cables, Switches & Breakers

DPH Series 200 ~ 600kVA						
UPS Capacity		200kVA/ 200kW	300kVA/ 300kW	400kVA/ 400kW	500kVA/ 500kW	600kVA/ 600kW
Power Module Q'ty		4	6	8	10	12
Input	Rated current at 220V with battery charging	340A	510A	680A	850A	1020A
	Recommended cable size (L1/ L2/ L3/ N)	95 mm ² × 2 PCS (4/0 AWG × 2 PCS)	185 mm ² × 2 PCS (400 kcmil × 2 PCS)	300 mm ² × 2 PCS (600 kcmil × 2 PCS)	240 mm ² × 3 PCS (500 kcmil × 3 PCS)	300 mm ² × 3 PCS (600 kcmil × 3 PCS)
	Maximum cable size (L1/ L2/ L3/ N)	300 mm ² × 3 PCS (600 kcmil × 3 PCS)				

DPH Series 200 ~ 600kVA						
UPS Capacity		200kVA/ 200kW	300kVA/ 300kW	400kVA/ 400kW	500kVA/ 500kW	600kVA/ 600kW
Input	Maximum Cable lug width	50 mm (1.97")				
	Screw size/ Cable lug inner diameter	M12/ 13 mm (0.51")				
	Terminal type*1	TLAPH325-2A12				
Bypass & Output	Rated current at voltage 220V	303A	455A	606A	758A	909A
	Recommended cable size (L1/ L2/ L3/ N)	70 mm ² × 2 PCS (3/0 AWG × 2 PCS)	150 mm ² × 2 PCS (300 kcmil × 2 PCS)	240 mm ² × 2 PCS (500 kcmil × 2 PCS)	185 mm ² × 3 PCS (400 kcmil × 3 PCS)	240 mm ² × 3 PCS (500 kcmil × 3 PCS)
	Maximum cable size (L1/ L2/ L3/ N)	300 mm ² × 3 PCS (600 kcmil × 3 PCS)				
	Maximum cable lug width	50 mm (1.97")				
	Screw size/ Cable lug inner diameter	M12/ 13 mm (0.51")				
	Terminal type*1	TLAPH325-2A12				
Battery	Nominal discharge current (condition: 12V × 40 PCS)	440A	660A	880A	1100A	1320A
	Maximum discharge current (condition: 9.6V × 40 PCS)	549A	823A	1097A	1371A	1645A
	Recommended cable size (+/ -/ N)	150 mm ² × 2 PCS (300 kcmil × 2 PCS)	300 mm ² × 2 PCS (600 kcmil × 2 PCS)	240 mm ² × 3 PCS (500 kcmil × 3 PCS)	185 mm ² × 4 PCS (400 kcmil × 4 PCS)	300 mm ² × 4 PCS (600 kcmil × 4 PCS)
	Maximum cable size (+/ -/ N)	300mm ² × 4 PCS (600 kcmil × 4 PCS)				

DPH Series 200 ~ 600kVA						
UPS Capacity		200kVA/ 200kW	300kVA/ 300kW	400kVA/ 400kW	500kVA/ 500kW	600kVA/ 600kW
Battery	Maximum Cable lug width	50 mm (1.97")				
	Screw size/ Cable lug inner diameter	M12/ 13 mm (0.51")				
	Terminal type*1	TLAPH325-2A12				
Tightening Torque		M12 = 500 ± 10 kgf-cm (434 ± 8.7 lb-in)				
Input Switch (Q1)		400A	600A	800A	1000A	1250A
Bypass Switch (Q2)		400A	600A	800A	1000A	1250A
Manual Bypass Switch (Q3)		400A	600A	800A	1000A	1250A
Output Switch (Q4)		400A	600A	800A	1000A	1250A
External Battery Cabinet's Breaker (Q5)		500A	800A	1000A	1250A	1600A



NOTE:

1. Please follow local regulations to install a suitable conduit and bushing for cable protection.
 2. Please refer to national and local electrical codes for acceptable protective devices and cable sizes.
 3. For the cables mentioned in **Table 5-2**, copper wires with PVC material and temperature resistance up to 105°C (221°F) are suggested.
 4. *1 The suggested manufacturer is K.S. TERMINALS INC. You may use equivalent terminals provided by other manufacturers.
- If there is a floating voltage between the input power's neutral (N) and the PE (protective earth) (⊕), and you require that the VNG of the UPS should be zero, we suggest that you install an isolation transformer in front of the input side of the UPS, and connect the isolation transformer's secondary neutral (N) to the PE (protective earth) (⊕) at the proximal end of the isolation transformer.
 - The (main/ bypass) AC source must be a three-phase four-wire system (Y configuration) and meets the specifications specified on the UPS rating label. Make sure the connection is in the positive phase sequence.
 - Check the battery polarity when connecting the external battery cabinet(s) to the UPS. Do not connect the battery polarity in reverse. For battery connection relevant information, please refer to **5.6 External Battery Cabinet Connection Warnings**.
 - The UPS's PE terminal (⊕) must be grounded. Please use ring-type terminals when wiring.

**WARNING:**

1. Wrong wiring will cause damage to the UPS and electric shock.
2. For single input, the UPS will not work normally if the main AC power's neutral (N) is not firmly connected or not connected to the AC Input neutral (N) terminal shown in **Figure 5-8**.

For dual input, the UPS will not work normally if the main AC power's neutral (N) and bypass power's neutral (N) are not firmly connected or not connected to the AC Input neutral (N) terminal shown in **Figure 5-8**.

3. If the UPS is not grounded, the power boards and components might be damaged after the UPS is powered on.

5.5.2 Single Input to Dual Input Modification

**WARNING:**

Only authorized Delta engineers or service personnel can modify single input/ dual input setup.

The UPS default setting is single input. If you want to modify it into dual input, please follow the procedures below.

- 1 Open the UPS's two front doors and unscrew the twelve screws to remove the upper and lower switch panels shown in **Figure 5-4**. After removing the upper and lower switch panels, you will see the AC Input terminals and the Bypass Input terminals shown in **Figure 5-5**.

(Internal View with Two Front Doors Open)

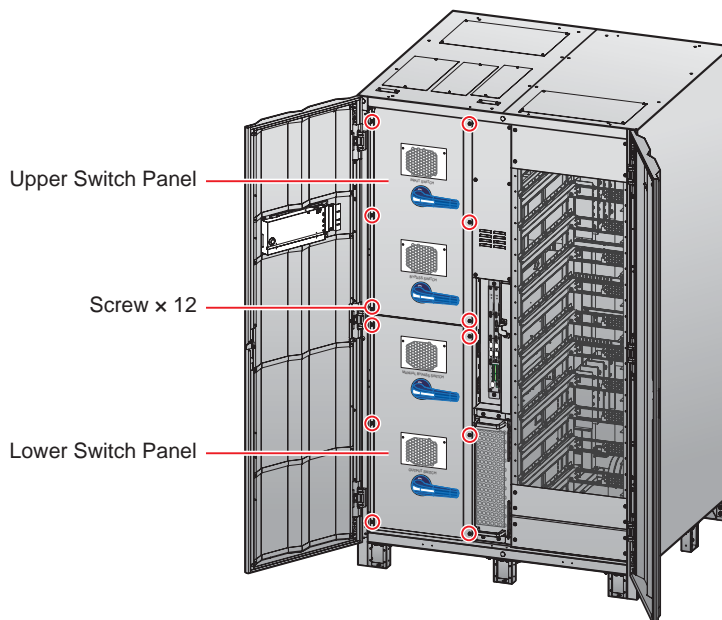

(Figure 5-4: Location of the Switch Panels and Screws)

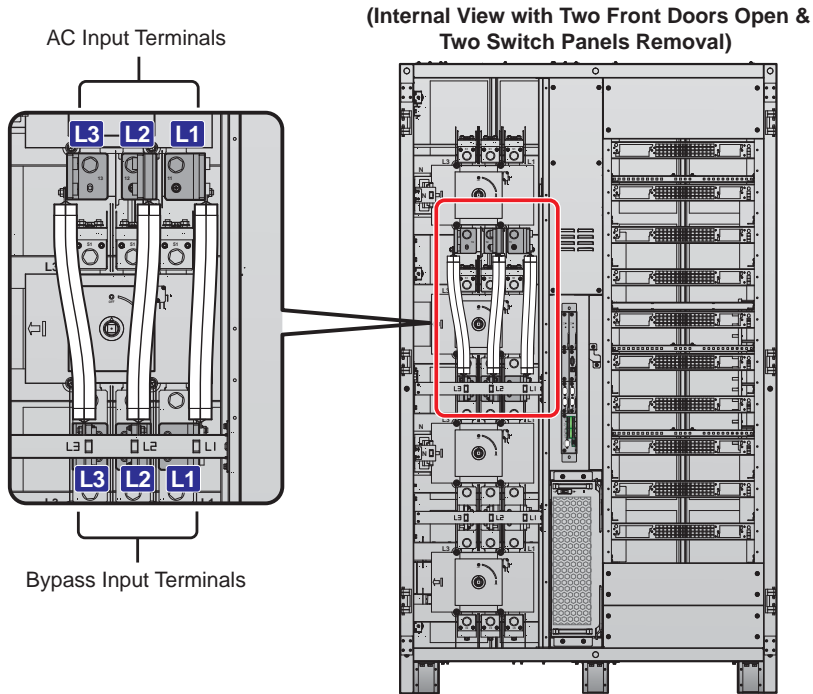

(Figure 5-5: Wiring Terminals_ AC Input & Bypass Input)

- ② Unscrew the twelve nuts to remove the twelve cables connected between the AC Input terminals (L1/ L2/ L3) and the Bypass Input terminals (L1/ L2/ L3) in order to modify the UPS from single input into dual input. Please refer to **Figure 5-6**.



NOTE:

1. There are four cables and four nuts used to connect the AC Input and Bypass Input's L1 Terminals.
2. There are four cables and four nuts used to connect the AC Input and Bypass Input's L2 Terminals.
3. There are four cables and four nuts used to connect the AC Input and Bypass Input's L3 Terminals.

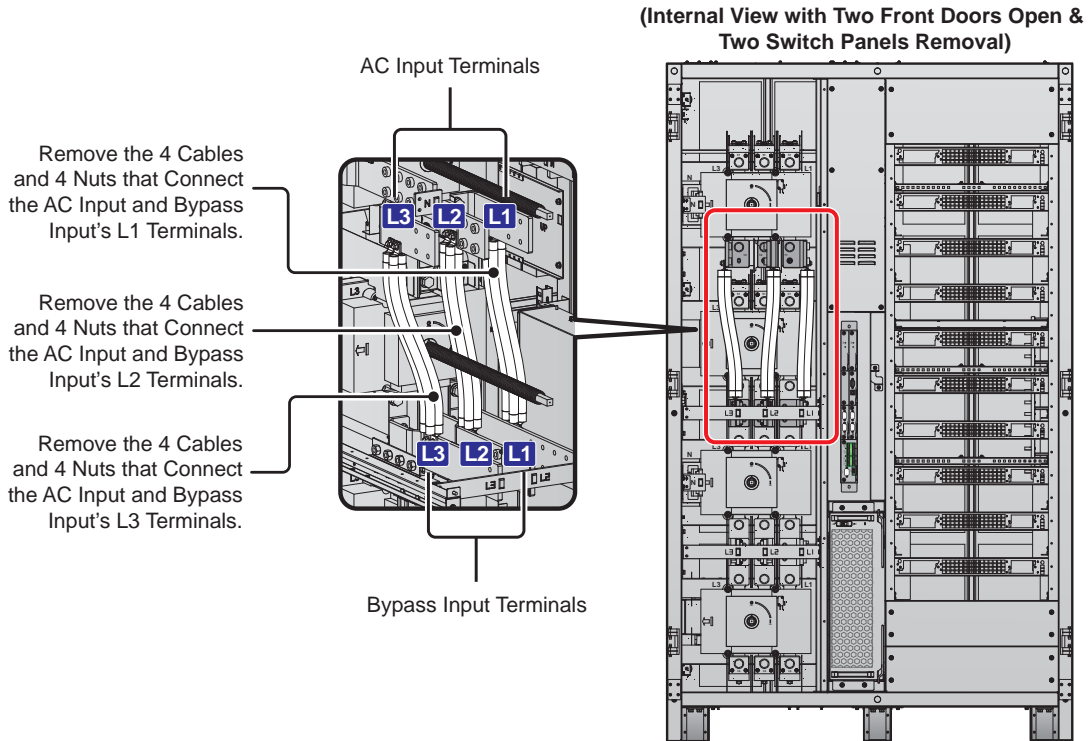

(Figure 5-6: Remove the Twelve Cables Connected between the AC Input Terminals (L1/ L2/ L3) and the Bypass Input Terminals (L1/ L2/ L3))



NOTE:

1. Please keep the twelve nuts and twelve cables well for future use.
2. If you want to modify the UPS from dual input into single input, please use the removed twelve nuts to connect the removed twelve cables to the AC Input Terminals (L1/ L2/ L3) and the Bypass Input Terminals (L1/ L2/ L3).

5.5.3 Single Unit Wiring



NOTE:

1. Only authorized Delta engineers or service personnel can perform installation, wiring, panel & cover removal, maintenance and operation. If you want to execute any action mentioned above by yourself, the action must be under the supervision of authorized Delta engineers or service personnel.
2. The UPS rating voltage is 220/ 380 Vac, 230/ 400 Vac or 240/ 415 Vac.
3. The external battery cabinet's rating voltage is ± 240 Vdc.
4. Before wiring, please read **5.5 Wiring**.

- **Single Input (Single Unit)**

When there is only one AC power source, single unit wiring procedures are as follows.

- 1 The UPS allows cable entry from the top or bottom. Please leave adequate space on the top or at the bottom of the UPS to allow cable entry.
- 2 Open the UPS's two front doors and unscrew the twelve screws to remove the upper and lower switch panels shown in **Figure 5-7**. After removing the upper and lower switch panels, you will see the wiring terminals shown in **Figure 5-8 ~ Figure 5-10**.

(Internal View with Two Front Doors Open)

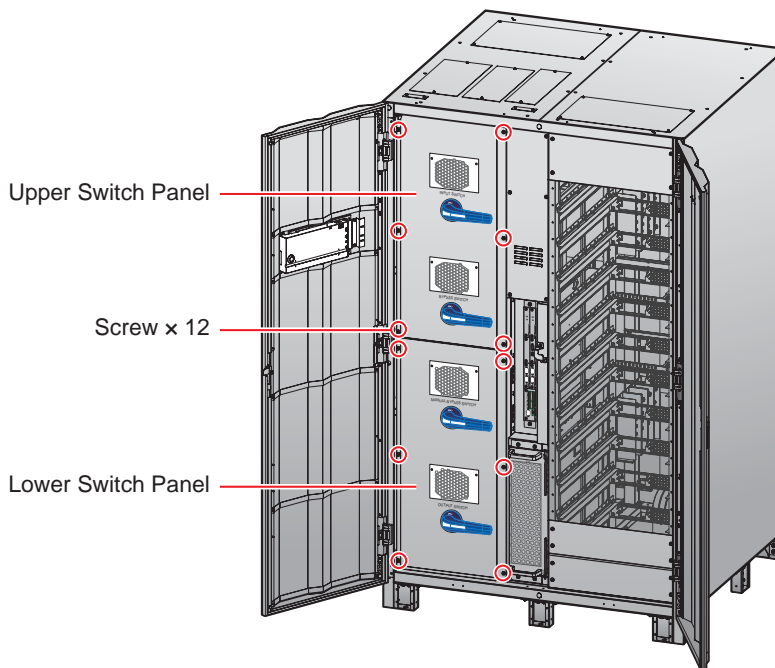

(Figure 5-7: Location of the Switch Panels and Screws)

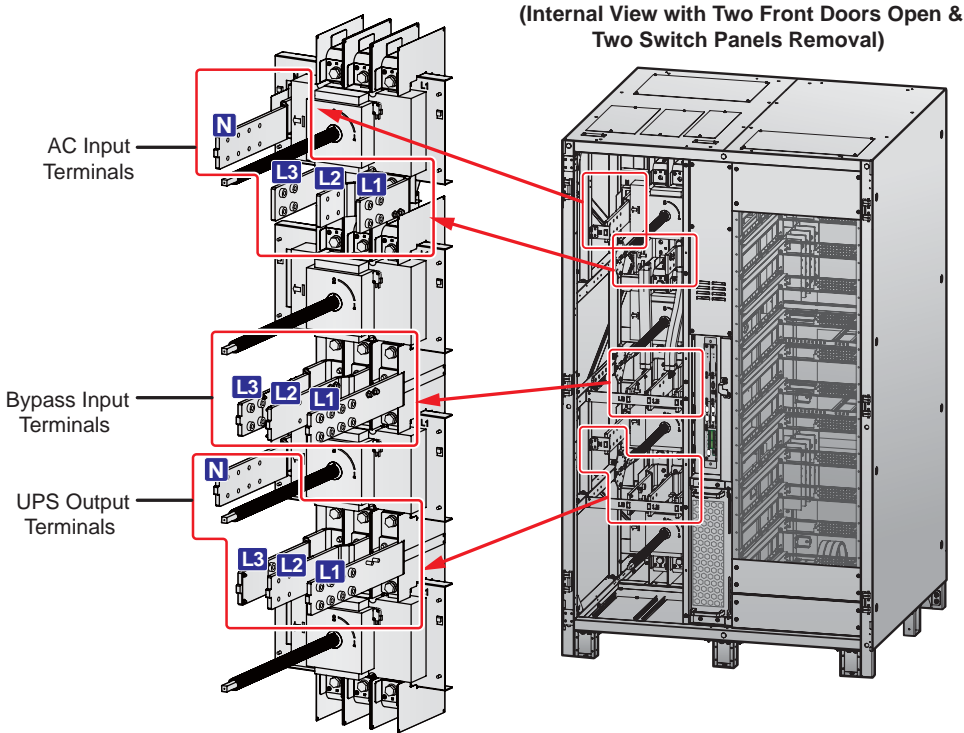

(Figure 5-8: Wiring Terminals_ AC Input, Bypass Input & UPS Output)

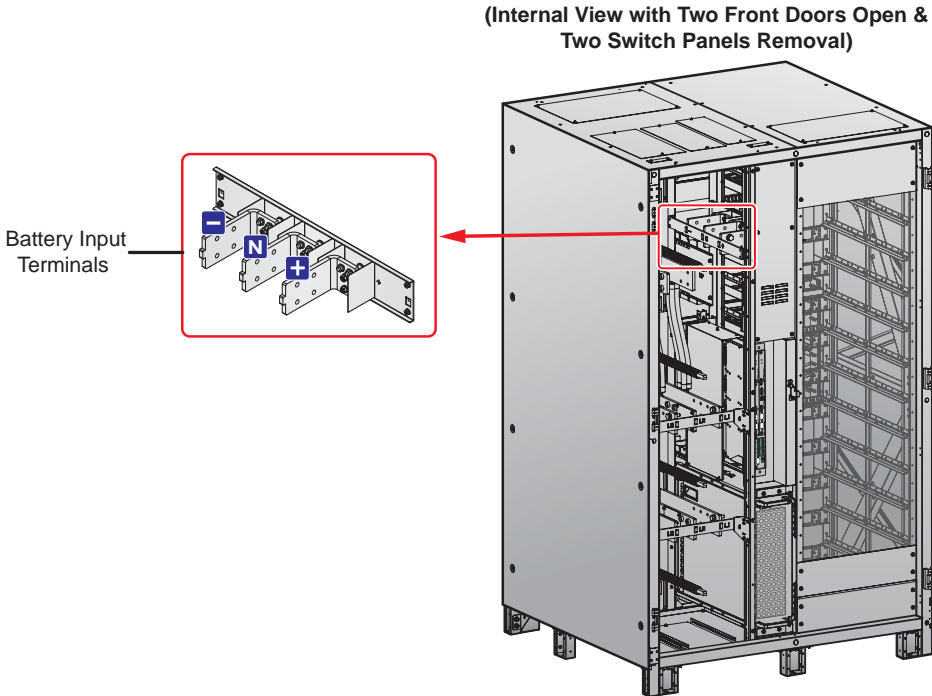

(Figure 5-9: Wiring Terminals_ Battery Input)

(Internal View with Two Front Doors Open & Two Switch Panels Removal)

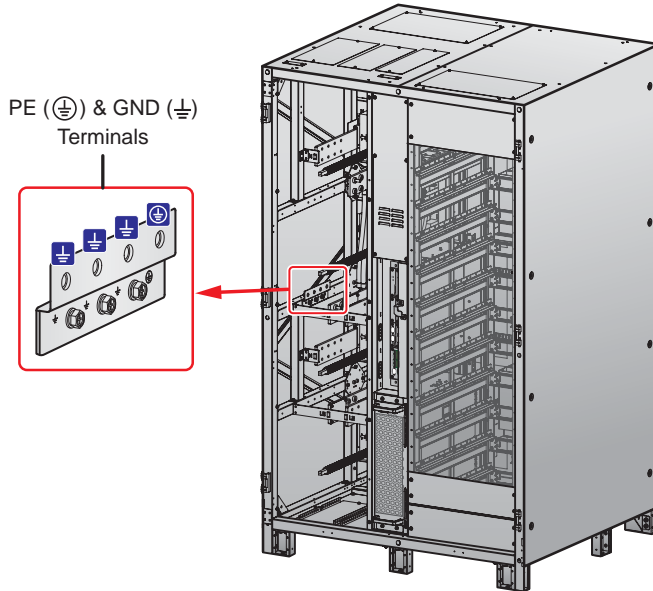

(Figure 5-10: Wiring Terminals_ Grounding)

- 3 For top wiring, please remove the three top covers shown in **Figure 5-11** for cable entry. Each top cover has two screws.

(Internal View with Two Front Doors Open & Two Switch Panels Removal)

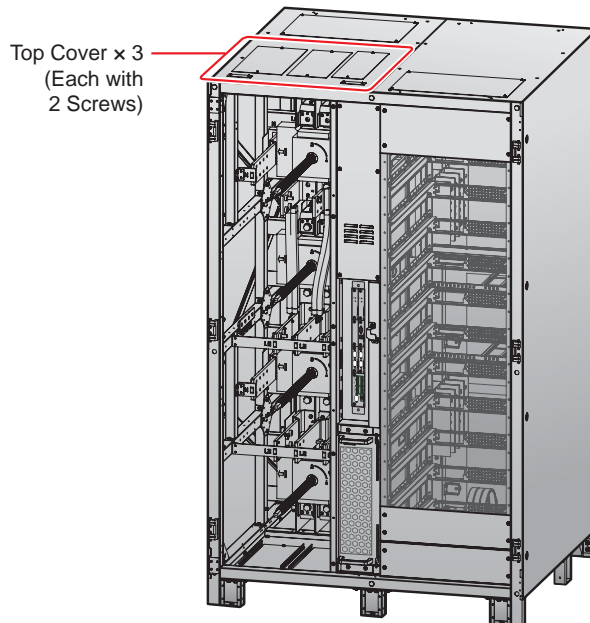

(Figure 5-11: Location of the Top Covers)

- 4 For bottom wiring, please remove the two bottom covers shown in **Figure 5-12** for cable entry. Each bottom cover has two screws.

(Internal View with Two Front Doors Open & Two Switch Panels Removal)

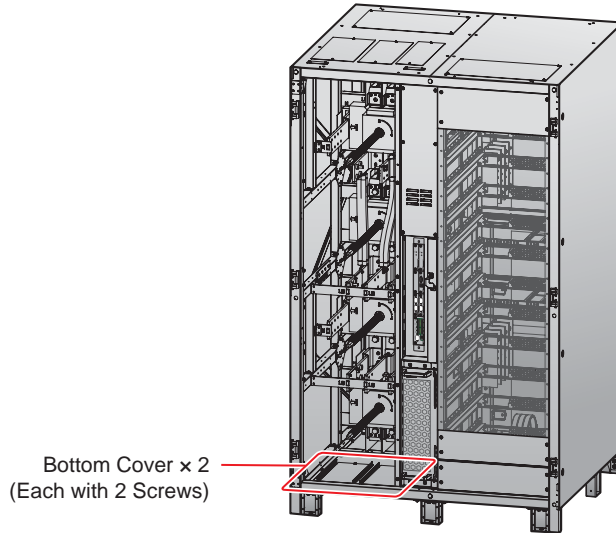

(Figure 5-12: Location of the Bottom Covers)

- 5 For wiring terminals and wiring information, please refer to **Table 5-3** and also cross-refer to **Figure 5-8 ~ Figure 5-16**.

Table 5-3: UPS's Wiring Terminals & Wiring Information

No.	Item	Function
1	AC Input Terminals (L1/ L2/ L3/ N)	Connect to the main AC source
2	Bypass Input Terminals (L1/ L2/ L3/ N)	<ul style="list-style-type: none"> • Single Input: There is no need to connect the Bypass Input terminals. • Dual Input: Connect to the bypass AC source. The bypass AC source's neutral (N) must be connected to the AC Input neutral (N) terminal.
3	UPS Output Terminals (L1/ L2/ L3/ N)	Connect to the critical loads.

No.	Item	Function
4	Battery Input Terminals (+/ -/ N)	Connect to the external battery cabinet(s). Please contact Delta service personnel for battery configurations.
5	⊕ PE (protective earth) Terminal	Protective earthing for protection against electrical shock in case of fault* ¹ . The terminal must be connected to the main earth.
6	⊥ GND (ground) Terminals	The terminals are used to ground the devices, which are associated with UPS operation.



NOTE:

*¹ The PE (protective earth) connection ensures that all exposed conductive surfaces are at the same electric potential as the Earth to avoid the risk of electrical shock due to leakage current or an insulation fault.

- 6 Make sure the Input Switch (Q1), Bypass Switch (Q2), Manual Bypass Switch (Q3) and Output Switch (Q4) are in the **OFF** position. Please refer to **Figure 2-4** and **Figure 2-5** for relevant information.
- 7 Make sure each external battery cabinet's breaker (Q5) is in the **OFF** position.
- 8 Follow **Table 5-2** to select proper input, output, and battery cables.
- 9 Connect the cables of the main AC source, output and external battery cabinet(s) to the UPS. Please refer to the following to perform wiring.

Figure 5-8: Wiring Terminals_ AC Input, Bypass Input & UPS Output

Figure 5-9: Wiring Terminals_ Battery Input

Figure 5-10: Wiring Terminals_ Grounding

Table 5-3: UPS's Wiring Terminals & Wiring Information

5.6 External Battery Cabinet Connection Warnings



NOTE:

For single input, the UPS will not work normally if the main AC power's neutral (N) is not firmly connected or not connected to the AC Input neutral (N) terminal shown in **Figure 5-8**.

- 10 Follow the table below to select proper Protective Earth (PE) cables to ground the UPS, external battery cabinet(s) and connected critical loads. The table is in accordance with **IEC 60364-5-54 (Article 543 and Table 54.2)**. The grounding diagram below is for reference.

DPH Series 200 ~ 600kVA						
UPS Capacity		200kVA/ 200kW	300kVA/ 300kW	400kVA/ 400kW	500kVA/ 500kW	600kVA/ 600kW
Suggested PE Cable Size	Input	25 mm ² × 1 PC (2 AWG × 1 PC)	50 mm ² × 1 PC (1/0 AWG × 1 PC)	67 mm ² × 1 PC (2/0 AWG × 1 PC)	70 mm ² × 1 PC (3/0 AWG × 1 PC)	95 mm ² × 1 PC (4/0 AWG × 1 PC)
	Bypass	25 mm ² × 1 PC (2 AWG × 1 PC)	50 mm ² × 1 PC (1/0 AWG × 1 PC)	67 mm ² × 1 PC (2/0 AWG × 1 PC)	70 mm ² × 1 PC (3/0 AWG × 1 PC)	95 mm ² × 1 PC (4/0 AWG × 1 PC)
	Output	25 mm ² × 1 PC (2 AWG × 1 PC)	50 mm ² × 1 PC (1/0 AWG × 1 PC)	67 mm ² × 1 PC (2/0 AWG × 1 PC)	70 mm ² × 1 PC (3/0 AWG × 1 PC)	95 mm ² × 1 PC (4/0 AWG × 1 PC)
	Battery	50 mm ² × 1 PC (1/0 AWG × 1 PC)	67 mm ² × 1 PC (2/0 AWG × 1 PC)	95 mm ² × 1 PC (4/0 AWG × 1 PC)	95 mm ² × 1 PC (4/0 AWG × 1 PC)	120 mm ² × 1 PC (250 kcmil × 1 PC)
Maximum Cable Lug Width		50 mm (1.97")				
Screw Size/ Cable Lug Inner Diameter		M12/ 13 mm (0.51")				
Tightening Torque		M12 = 500 ± 10 kgf-cm (434 ± 8.7 lb-in)				
Terminal Type*1		TLAPH325-2A12				



NOTE:

*1 The suggested manufacturer is K.S. TERMINALS INC. You may use equivalent terminals provided by other manufacturers.

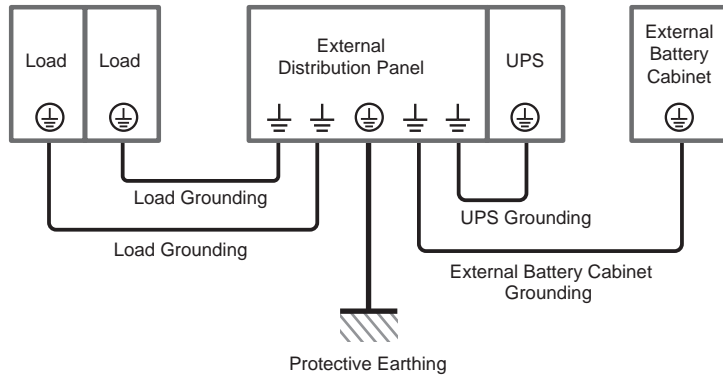

(Figure 5-13: Grounding Diagram_ Single Unit)

- **Dual Input (Single Unit)**

When there are two AC power sources, single unit wiring procedures are as follows.

- 1 Follow **5.5.2 Single Input to Dual Input Modification** to modify the UPS from single input into dual input.
- 2 Follow the procedures 1 ~ 8 stated in the section of **Single Input (Single Unit)**.
- 3 Connect the cables of the main AC source, bypass source, output and external battery cabinet(s) to the UPS. Please refer to the following to perform wiring.

Figure 5-8: Wiring Terminals_ AC Input, Bypass Input & UPS Output

Figure 5-9: Wiring Terminals_ Battery Input

Figure 5-10: Wiring Terminals_ Grounding

Table 5-3: UPS's Wiring Terminals & Wiring Information

5.6 External Battery Cabinet Connection Warnings



NOTE:

For dual input, the UPS will not work normally if the main AC power's neutral (N) and bypass power's neutral (N) are not firmly connected or not connected to the AC Input neutral (N) terminal shown in **Figure 5-8**.

- 4 Follow **Figure 5-13** to ground the UPS, external battery cabinet(s) and connected critical loads.

5.5.4 Parallel Units Wiring



NOTE:

1. Only authorized Delta engineers or service personnel can perform installation, wiring, panel & cover removal, maintenance and operation. If you want to execute any action mentioned above by yourself, the action must be under the supervision of authorized Delta engineers or service personnel.
2. Up to eight UPS units can be paralleled for redundancy and capacity expansion. Only the UPSs with the same capacity, voltage, frequency, version and serial No. can be paralleled. For version and serial No. information, please refer to **7.11.7 Version & S/N**. Please only use the provided parallel cable to parallel the UPS units. Otherwise, parallel functions will fail.
3. When the UPSs are paralleled, the length of each unit's bypass input cables plus output cables must be the same. This ensures that the parallel UPSs can equally share the critical loads in bypass mode.

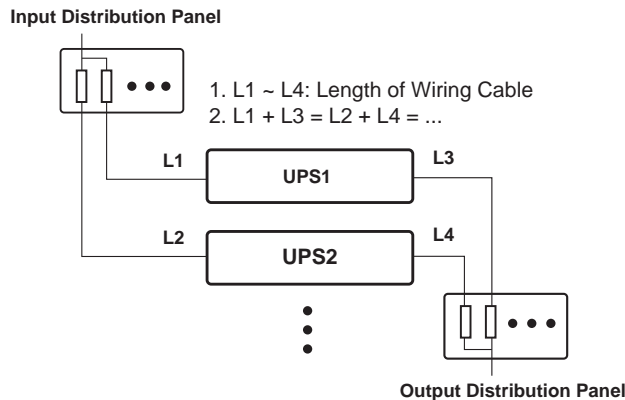

4. The UPS's rating voltage is 220/ 380Vac, 230/ 400Vac or 240/ 415Vac.
5. The external battery cabinet's rating voltage is ± 240 Vdc.
6. Before wiring, please read **5.5 Wiring** thoroughly and make sure relevant conditions have been met.

- **Single Input (Parallel Units)**

When there is only one AC power source, parallel units' wiring procedures are as follows.

- 1 Follow the procedures 1 ~ 8 stated in the section of **Single Input (Single Unit)**.
- 2 Connect the cables of the main AC source, output and external battery cabinet(s) to the UPS. Please refer to the following to perform wiring.

Figure 5-8: Wiring Terminals_ AC Input, Bypass Input & UPS Output

Figure 5-9: Wiring Terminals_ Battery Input

Figure 5-10: Wiring Terminals_ Grounding

Table 5-3: UPS's Wiring Terminals & Wiring Information

Figure 5-14: Parallel Units Single Input Wiring Diagram

5.6 External Battery Cabinet Connection Warnings

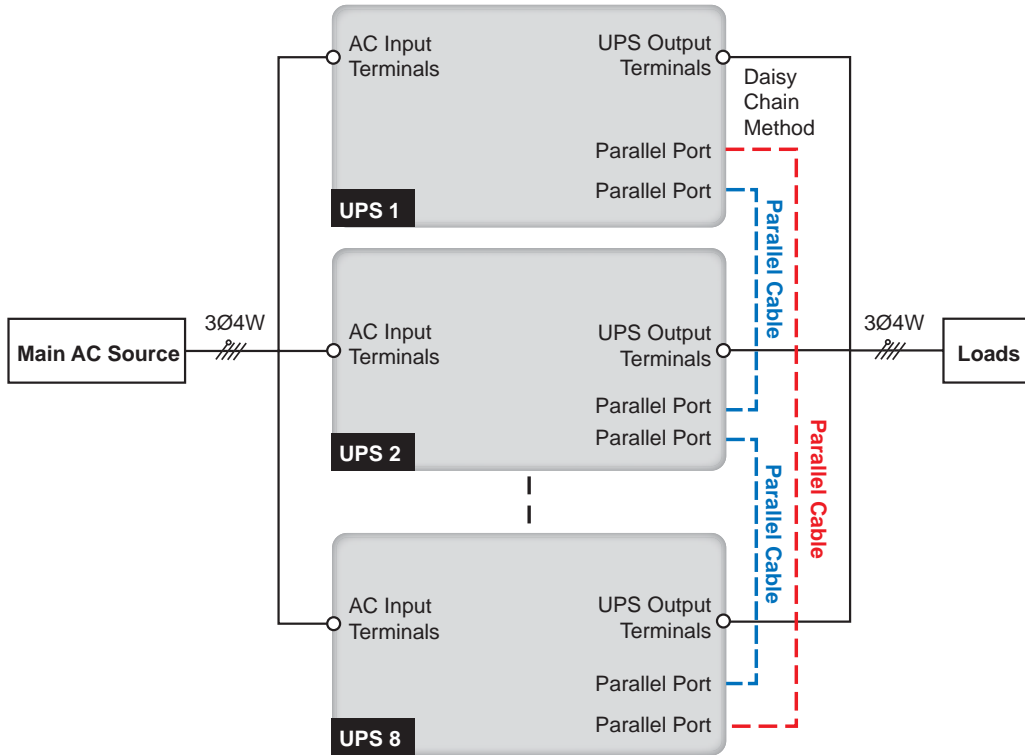

(Figure 5-14: Parallel Units Single Input Wiring Diagram)



NOTE:

For single input, the UPS will not work normally if the main AC power's neutral (N) is not firmly connected or not connected to the AC Input neutral (N) terminal shown in **Figure 5-8**.

3

Use the provided parallel cables*¹ to connect the parallel ports of the parallel units. Please adopt the Daisy Chain method shown in the figure below. For the parallel port location, refer to **Figure 4-3**.



NOTE:

*¹ One parallel cable is provided in each UPS's accessory package.

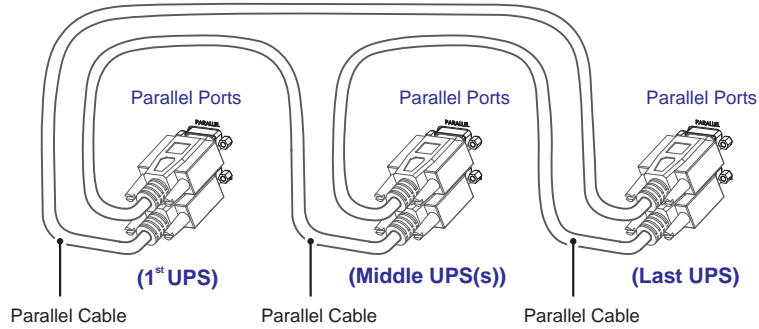

(Figure 5-14-1: Parallel Port Connection_ Daisy Chain Method)

- 4 Follow the table below to select proper Protective Earth (PE) cables to ground the parallel UPS units, external battery cabinet(s) and connected critical loads. The table is in accordance with IEC 60364-5-54 (Article 543 and Table 54.2). The grounding diagram below is for reference.

DPH Series 200 ~ 600kVA						
UPS Capacity		200kVA/ 200kW	300kVA/ 300kW	400kVA/ 400kW	500kVA/ 500kW	600kVA/ 600kW
Suggested PE Cable Size	Input	25 mm ² × 1 PC (2 AWG × 1 PC)	50 mm ² × 1 PC (1/0 AWG × 1 PC)	67 mm ² × 1 PC (2/0 AWG × 1 PC)	70 mm ² × 1 PC (3/0 AWG × 1 PC)	95 mm ² × 1 PC (4/0 AWG × 1 PC)
	Bypass	25 mm ² × 1 PC (2 AWG × 1 PC)	50 mm ² × 1 PC (1/0 AWG × 1 PC)	67 mm ² × 1 PC (2/0 AWG × 1 PC)	70 mm ² × 1 PC (3/0 AWG × 1 PC)	95 mm ² × 1 PC (4/0 AWG × 1 PC)
	Output	25 mm ² × 1 PC (2 AWG × 1 PC)	50 mm ² × 1 PC (1/0 AWG × 1 PC)	67 mm ² × 1 PC (2/0 AWG × 1 PC)	70 mm ² × 1 PC (3/0 AWG × 1 PC)	95 mm ² × 1 PC (4/0 AWG × 1 PC)
	Battery	50 mm ² × 1 PC (1/0 AWG × 1 PC)	67 mm ² × 1 PC (2/0 AWG × 1 PC)	95 mm ² × 1 PC (4/0 AWG × 1 PC)	95 mm ² × 1 PC (4/0 AWG × 1 PC)	95 mm ² × 1 PC (250 kcmil × 1 PC)
Maximum Cable Lug Width		50 mm (1.97")				
Screw Size/ Cable Lug Inner Diameter		M12/ 13 mm (0.51")				
Tightening Torque		M12 = 500 ± 10 kgf-cm (434 ± 8.7 lb-in)				
Terminal Type*1		TLAPH325-2A12				

**NOTE:**

*1 The suggested manufacturer is K.S. TERMINALS INC. You may use equivalent terminals provided by other manufacturers.

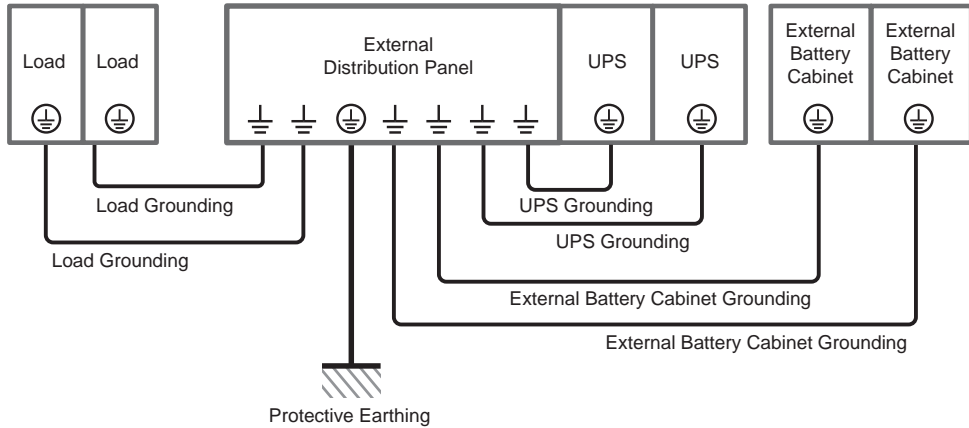

(Figure 5-15: Grounding Diagram_ Parallel Units)

**WARNING:**

Before start-up of the parallel units, qualified service personnel must set each UPS's '**Parallel Group ID**' (1 or 2) and '**Parallel ID**' (1 ~ 8) through the LCD. Otherwise, the parallel UPSs cannot be started. Please refer to **7.10.5 Parallel Setting**.

- **Dual Input (Parallel Units)**

When there are two AC power sources, parallel units' wiring procedures are as follows.

- 1 Follow **5.5.2 Single Input to Dual Input Modification** to modify the UPS from single input to dual input.
- 2 Follow the procedures 1 ~ 8 stated in the section of **Single Input (Single Unit)**.
- 3 Connect the cables of the main AC source, bypass source, output and external battery cabinet(s) to the UPS. Please refer to the following to perform wiring.

Figure 5-8: Wiring Terminals_ AC Input, Bypass Input & UPS Output

Figure 5-9: Wiring Terminals_ Battery Input

Figure 5-10: Wiring Terminals_ Grounding

Table 5-3: UPS's Wiring Terminals & Wiring Information

Figure 5-16: Parallel Units Dual Input Wiring Diagram

5.6 External Battery Cabinet Connection Warnings

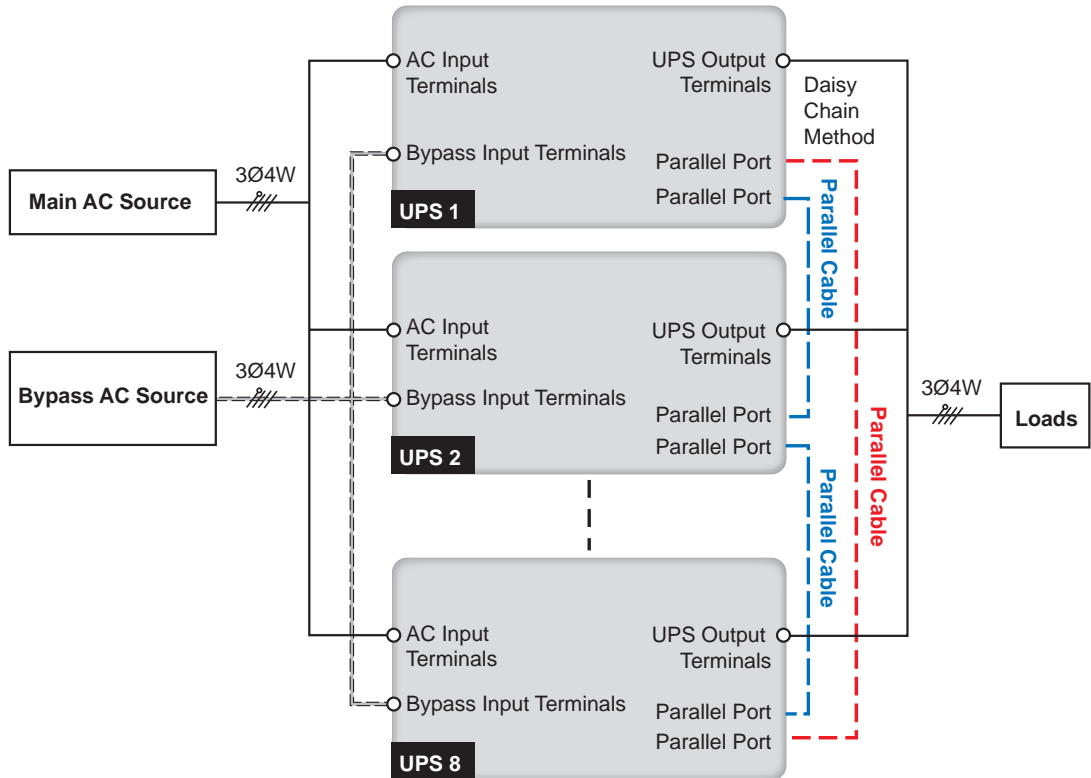

(Figure 5-16: Parallel Units Dual Input Wiring Diagram)



NOTE:

For dual input, the UPS will not work normally if the main AC power's neutral (N) and bypass power's neutral (N) are not firmly connected or not connected to the AC Input neutral (N) terminal shown in **Figure 5-8**.

- 4 Use the provided parallel cables*¹ to connect the parallel ports of the parallel units. Please adopt the Daisy Chain method shown in **Figure 5-14-1**. For the parallel port location, refer to **Figure 4-3**.



NOTE:

*¹ One parallel cable is provided in each UPS's accessory package.

- 5 Follow **Figure 5-15** to ground the parallel UPS units, external battery cabinet(s) and connected critical loads.



WARNING:

Before start-up of the parallel units, qualified service personnel must set each UPS's '**Parallel Group ID**' (1 or 2) and '**Parallel ID**' (1 ~ 8) through the LCD. Otherwise, the parallel UPSs cannot be started. Please refer to **7.10.5 Parallel Setting**.

5.6 External Battery Cabinet Connection Warnings



NOTE:

1. The information of the battery parameters in this chapter may not be applicable to the lithium-ion batteries. For relevant information, please refer to the manual of the lithium-ion batteries.
2. Whether you use the lead-acid batteries or the lithium-ion batteries, please contact Delta service personnel for any battery/ battery cabinet's setup and configurations.

You should connect the UPS with at least one external battery cabinet to ensure that the connected critical loads are protected when a power failure occurs. You can connect up to eight units of external battery cabinets to the UPS.

- To ensure that the batteries are fully charged, please charge the batteries at least 8 hours before first use of the UPS. The charging procedures are as follows:
 1. Connect the UPS to the main AC source and the external battery cabinet(s). Please see **5. Installation and Wiring**.
 2. Follow **6. UPS Operation** to turn on the UPS and the external battery cabinet(s). After the UPS is turned on, the UPS will automatically charge the batteries.



WARNING:

You can connect the critical loads to the UPS only after the batteries are fully charged. This guarantees that the UPS can provide sufficient backup power to the critical loads connected when a power failure occurs.

- **Battery Parameters**

No.	Item	Description
1	Charge Voltage	Float charge voltage: ± 272 Vdc (default)
		Equalized charge voltage: ± 280 Vdc (default)
2	Charge Current	Default: ± 5 A (per power module)
		Maximum: ± 15 A (per power module)
3	Low Battery Shutdown Voltage	$\pm 200 \sim \pm 220$ Vdc (default: ± 210 Vdc)
4	The Number of Batteries	12V \times 40 PCS (default)

**NOTE:**

1. The charge current is adjustable from 6A to the maximum in increments of 1A.
 2. If you need to modify the default charge current setting and default low battery shutdown setting, please contact your local dealer or service personnel.
 3. Follow on-site requirements to choose 12V × 30/ 32/ 34/ 36/ 38/ 40/ 42/ 44/ or 46 PCS of batteries. Changing the battery quantity will influence specifications to be applied. For battery selection, installation and replacement, please contact your local dealer or customer service.
 4. You must set up the '**Battery Rating Voltage**', '**Battery Strings**' and '**Capacity**' on the LCD according to on-site conditions; otherwise, batteries will be over-charged, not fully charged or even seriously damaged.
- Only use the same type of batteries from the same supplier. Never use old, new and different Ah batteries at the same time.
 - The number of batteries must meet UPS requirements.
 - Do not connect the batteries in reverse.
 - Use a voltage meter to measure whether the total voltage, after the external battery cabinet connection, is around 12.5Vdc × the total number of batteries.
 - The default number of batteries is 40 PCS of 12V batteries connected in string, and you should connect the external battery cabinet's neutral (N) to the middle 20th and 21st batteries. You should use battery cables to connect the external battery cabinet with the '+', '-' and 'N' terminals marked on the UPS. Please refer to **Figure 5-17**.

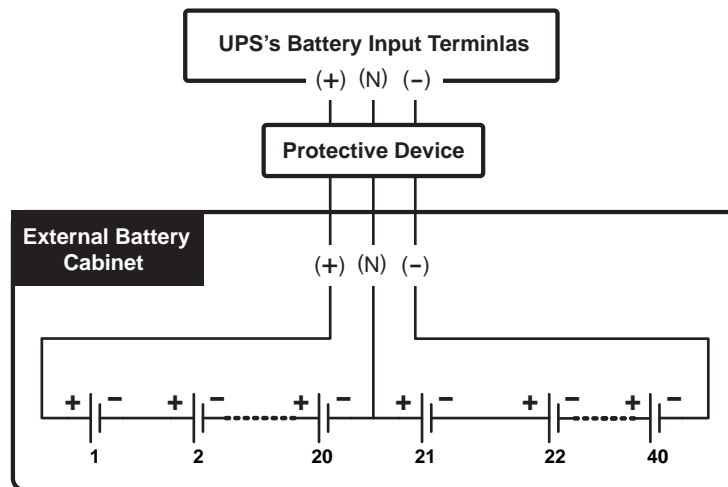

(Figure 5-17: External Battery Cabinet Connection)

**WARNING:**

The electrolyte leakage of the batteries can lead to serious accidents. For safety concerns, you must insulate the batteries properly (using insulated trays or boxes) from the metal cabinets and racks.

- Please follow your UPS rating to install an appropriate protective device for each external battery cabinet. There are two installation methods for selection.
 1. A 4-pole DC circuit breaker or DC isolated switch connected in series with a DC fuse
 2. A 3-pole DC circuit breaker or DC isolated switch connected in series with a DC fuse

For relevant values, please refer to **Table 5-4**; for relevant installation diagrams, please refer to **Figure 5-18 ~ Figure 5-19**.

Table 5-4: External Battery Cabinet's Protective Device (Default Battery Q'ty: 12Vdc x 40 PCS)

UPS Rating	Power Module Q'ty	4-Pole DC Circuit Breaker or 4-Pole DC Isolated Switch (Per Pole Voltage $\geq 250\text{Vdc}$)	3-Pole DC Circuit Breaker or 3-Pole DC Isolated Switch (Per Pole Voltage $\geq 500\text{Vdc}$)	DC fuse (voltage $\geq 500\text{Vdc}$)
200kVA/ 200kW	4	500A	500A	450A
300kVA/ 300kW	6	800A	800A	700A
400kVA/ 400kW	8	1000A	1000A	900A
500kVA/ 500kW	10	1200A	1200A	1200A
600kVA/ 600kW	12	1600A	1600A	1400A

**NOTE:**

1. **Table 5-4** is for 12Vdc × 40 PCS batteries (default). If you install a different number of batteries, please contact Delta service personnel for protective device's current and voltage.
 2. The above-mentioned DC circuit breaker, DC isolated switch and DC fuse are optional. If you want to buy any of them, please contact Delta service personnel.
 3. If you need to parallel multiple units of external battery cabinets, please contact Delta service personnel for relevant information.
 4. To extend backup time, you can parallel up to eight units of external battery cabinets to the UPS. Please note that (1) the number of batteries in each parallel external battery cabinet shall be the same and that (2) the cable length of each battery string shall be the same.
- Please note that only authorized Delta engineers or service personnel can perform wiring or you can perform wiring only under the supervision of authorized Delta engineers or service personnel. To connect the external battery cabinet(s) to the UPS, please refer to:
 - Figure 5-8: Wiring Terminals_ AC Input, Bypass Input & UPS Output**
 - Figure 5-9: Wiring Terminals_ Battery Input**
 - Figure 5-10: Wiring Terminals_ Grounding**
 - Figure 5-14: Parallel Units Single Input Wiring Diagram**
 - Figure 5-16: Parallel Units Dual Input Wiring Diagram**
 - Table 5-3: UPS's Wiring Terminals & Wiring Information**
 - Table 5-4: External Battery Cabinet's Protective Device (Default Battery Q'ty: 12Vdc × 40 PCS)**
 - For the external battery cabinet's grounding information, please refer to:
 - Figure 5-13: Grounding Diagram_ Single Unit**
 - Figure 5-15: Grounding Diagram_ Parallel Units**
 - When choosing the external battery cabinet's protective device, please take the following factors into consideration: (1) over current between the UPS and battery circuit, (2) short circuit current of the batteries, (3) wire/ cable materials, and (4) local electrical regulations. If you have any questions about the external battery cabinet's protective device, please contact Delta service personnel.
 - The protective device is optional, and its type must be fast-acting DC circuit breaker and/ or fast-acting DC fuse. If you want to buy any of them, please contact Delta service personnel. When choosing the protective device, please follow the instructions below.

1. The protective device's rated current must comply with the current values shown in **Table 5-4**.
 2. The specifications of the protective device's short-circuit protection (i.e. the tripping current of the fast-acting DC circuit breaker or/ and the melting current of the fast-acting DC fuse) must be 3 ~ 6 times the values shown in **Table 5-4**. Besides, the response time of the protective device must be less than 20ms.
 3. For the choice of the fast-acting DC fuse mentioned above, the A50QS series from the supplier **Ferraz Shawmut** is suggested. Please contact Delta customer service for relevant information.
 4. The maximum tripping current of the fast-acting DC circuit breaker or/ and the maximum melting current of the fast-acting DC fuse mentioned above are 3 ~ 8 times the values shown in **Table 5-4**. These maximum values are suggested for general applications only. For actual maximum values, the maximum short-circuit capacity of the on-site batteries must be taken into consideration. Please contact Delta customer service for relevant information.
- The external battery cabinet's protective device installation methods are as follows.

Option 1: Installation of a 4-pole DC circuit breaker or DC isolated switch (per pole voltage $\geq 250\text{Vdc}$) connected in series with a DC fuse (voltage $\geq 500\text{Vdc}$)

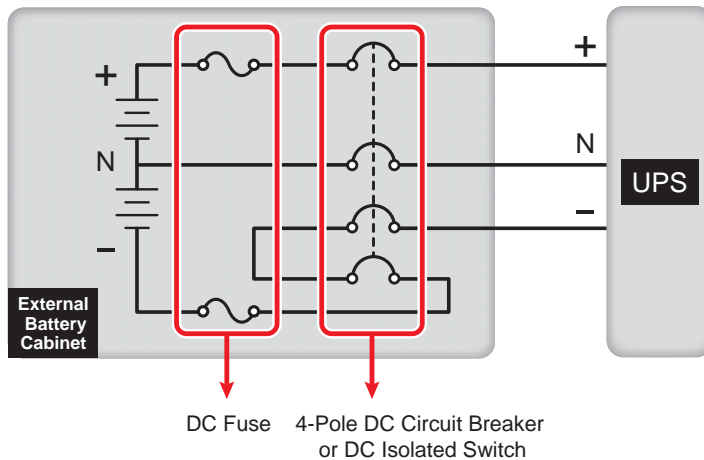

(Figure 5-18: Installation of a 4-Pole DC Circuit Breaker or DC Isolated Switch Connected in Series with a DC Fuse)

Option 2: Installation of a 3-pole DC circuit breaker or DC isolated switch (per pole voltage $\geq 500\text{Vdc}$) connected in series with a DC fuse (voltage $\geq 500\text{Vdc}$)

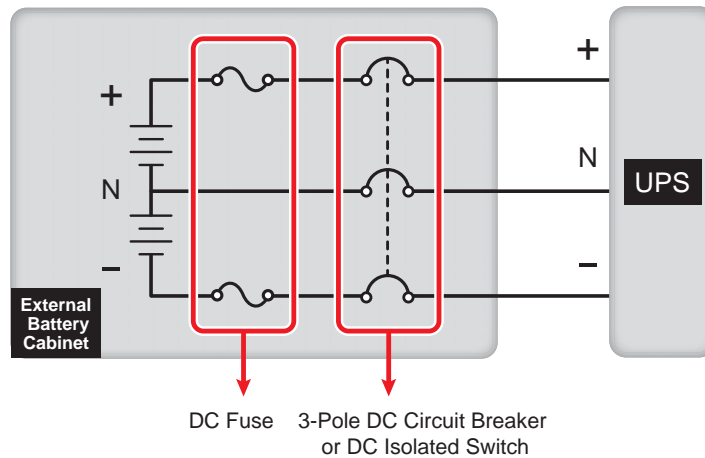

(Figure 5-19: Installation of a 3-Pole DC Circuit Breaker or DC Isolated Switch Connected in Series with a DC Fuse)

- To save on your costs and installation space, the parallel UPSs (8 units at maximum) can share their connected external battery cabinet(s). For relevant information, please refer to **3.4 Common Battery (Only for Parallel UPSs Connecting to the Same External Battery Cabinet(s))**.



WARNING:

- Before performing battery/ battery cabinet installation, wiring and replacement, please turn off each external battery cabinet's breaker (Q5) to completely disconnect the battery power from the UPS.
- A battery can present a risk of electric shock and high short-circuit current. Servicing of batteries and battery cabinets must be performed or supervised by qualified service personnel knowledgeable in batteries, battery cabinets and the required precautions. Keep unauthorized personnel away from batteries and battery cabinets.

• External Battery Cabinet Alarm

When any external battery cabinet connected to the UPS has the following problems, the UPS system will sound an alarm. Please see the table below.

No.	External Battery Cabinet Status	Alarm
1	Battery Abnormal - Reversed	Sounds 50 ms every second.
2	Battery Ground Fault	Sounds 50 ms every second.
3	Battery Over Temperature	Sounds 50 ms every second.

No.	External Battery Cabinet Status	Alarm
4	Battery Under Temperature	Sounds 50 ms every second.
5	Battery Breaker Off	Sounds 50 ms every 3 seconds.
6	Battery Disconnected (Missing)	Sounds once every second.
7	Battery Over Charged	Long beep.
8	Battery Test Fail	Sounds 50 ms every second.
9	Battery End of Discharge Imminent	Sounds 50 ms every second.
10	Battery End of Discharge	Long beep.
11	Battery Life Time Expired	Sounds 50 ms every 3 seconds.

5.7 STS Module

The hot swappable STS module has been installed inside the UPS in the Delta factory before shipment. Please see **Figure 5-20** for its location.

(Internal View with Two Front Doors Open)

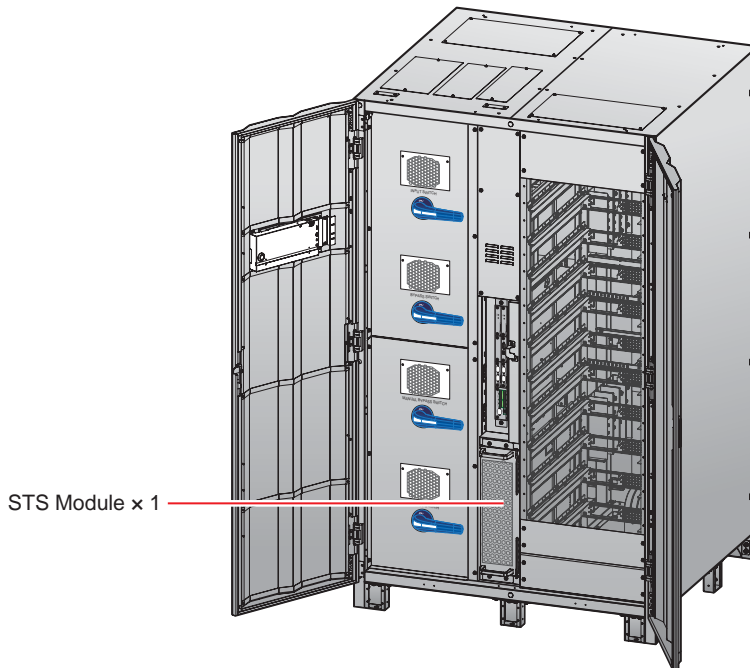

(Figure 5-20: Location of the STS Module)

For STS module illustration, please refer to **Figure 5-21**.

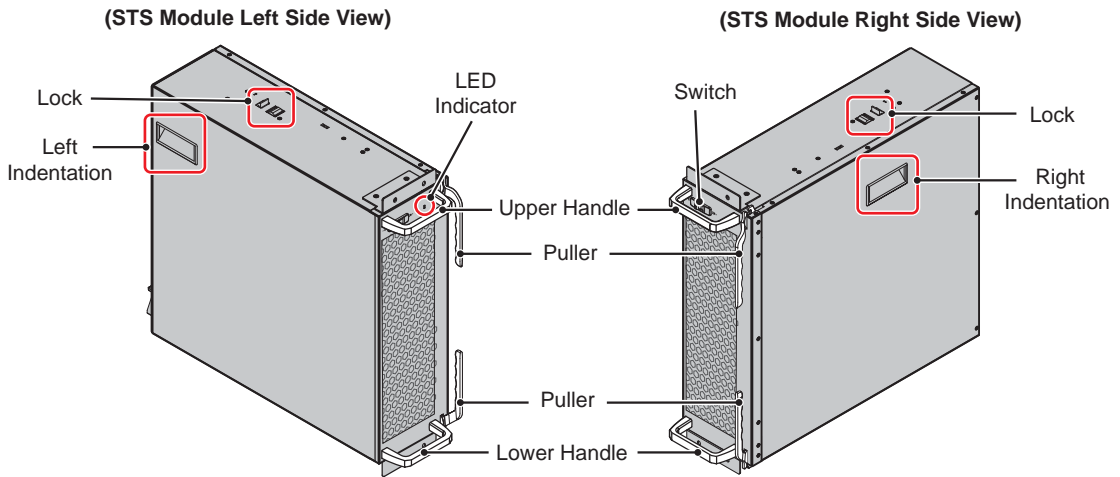

(Figure 5-21: STS Module)

5.7.1 STS Module Installation

The hot swappable STS module has been installed inside the UPS in the Delta factory before shipment. If the STS module is removed for some reasons and you want to re-install it, please follow the steps below:



NOTE:

1. Only qualified service personnel can perform the following STS module installation procedures.
2. The STS module is heavy (> 38 kg (83.8 lb)). At least two people are required for handling.

- 1 Confirm that the STS module's switch is in the lower position () and the pullers are in the open status. Please refer to **Figure 5-22** and **Figure 5-23**.

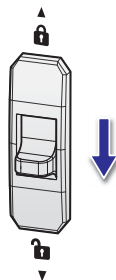

(Figure 5-22: Confirm the STS Module's Switch in the Lower Position)

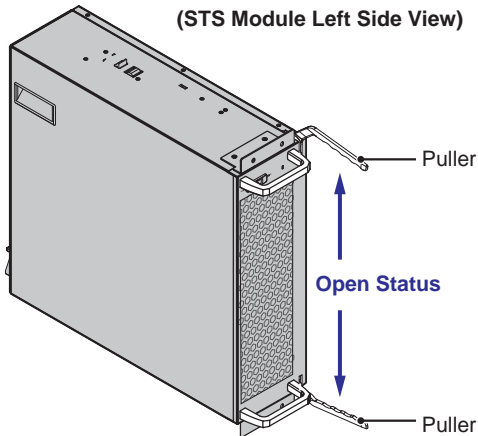

(Figure 5-23: Confirm the Pullers in the Open Status)

- 2 Two people are required. Each person holds one handle 1 and one indentation 2 of the STS module and two people work together to insert the STS module into the designated slot 3. After that, one person holds the two pullers 4 and push the two pullers inward in order to push the module into the end of the UPS cabinet until it snaps into place. Now, the two pullers are in the closed status.



NOTE:

The person who holds the upper handle must hold the left indentation and the person who holds the lower handle must hold the right indentation. For the indentation location, please refer to **Figure 5-21**.

(Internal View with Two Front Doors Open)

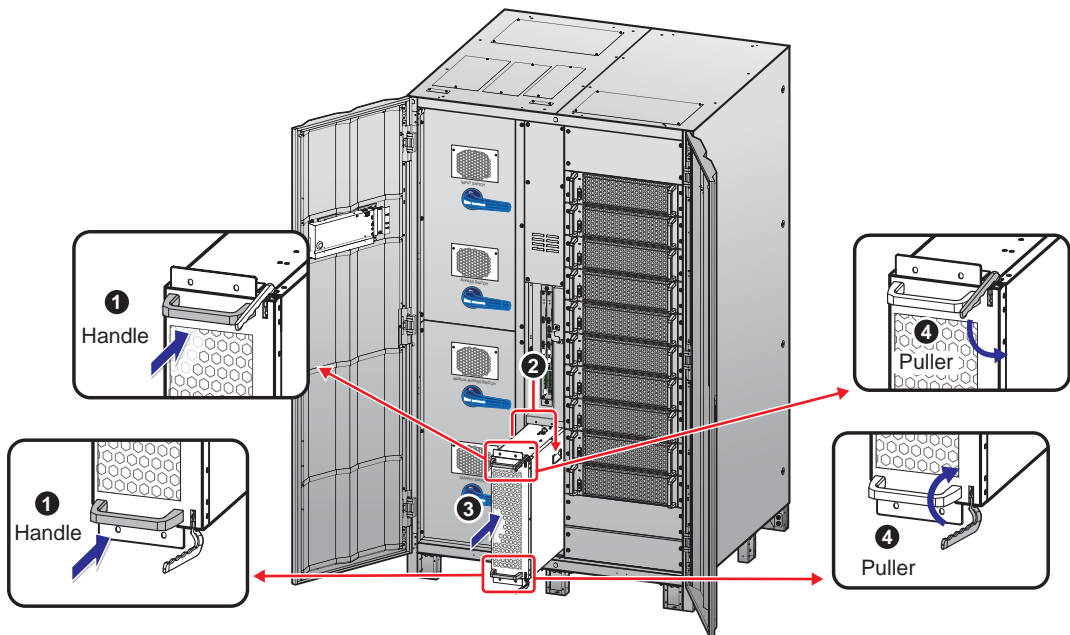

(Figure 5-24: Insert the STS Module into the UPS Cabinet)

- 3 Re-install the four screws (removed during the STS module removal process) to firmly fix the STS module's bracket ears on the UPS cabinet.

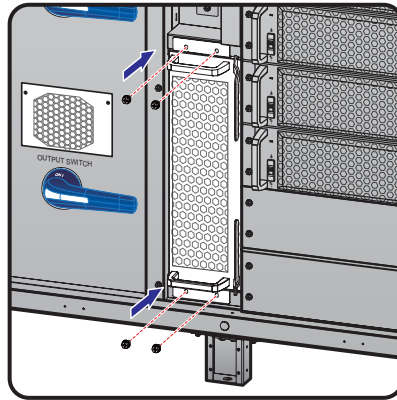

(Figure 5-25: Fix the STS Module on the UPS)

- 4 Turn the STS module's switch to the upper position ().

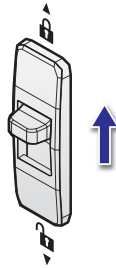

(Figure 5-26: Turn the STS Module's Switch to the Upper Position)

5.7.2 STS Module Removal



WARNING:

1. Only qualified service personnel can perform the following STS module removal procedures.
2. The STS module is heavy (> 38 kg (83.8 lb)). At least two people are required for handling.

- 1 Turn the STS module's switch to the lower position () and wait until the STS module's LED indicator becomes off.

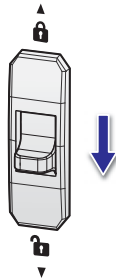

(Figure 5-27: Turn the STS Module's Switch to the Lower Position)

- 2 Remove the four screws from the STS module shown in **Figure 5-28**.

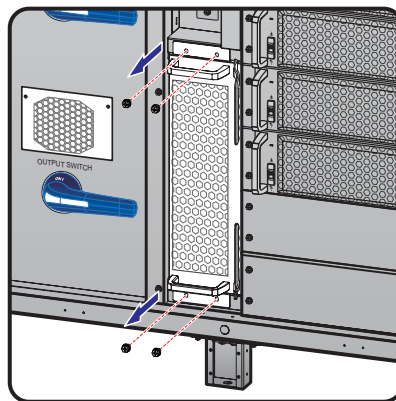

(Figure 5-28: Remove the Four Screws)

- 3 Two people are required. One person holds the STS module's two pullers and opens the two pullers outward **1**. After that, the STS module can be pulled out from the UPS cabinet **2**. Next, each person holds one handle **3** and two people work together to pull out the STS module from the UPS cabinet. When the STS module cannot be pulled out any more, press the lock (see **Figure 5-30**) on the top of the STS module. Now, each person holds one handle **3** and one indentation **4** of the STS module to continuously pull out the module from the UPS cabinet.



NOTE:

The person who holds the upper handle must hold the left indentation and the person who holds the lower handle must hold the right indentation. For the indentation location, please refer to **Figure 5-30**.

(Internal View with Two Front Doors Open)

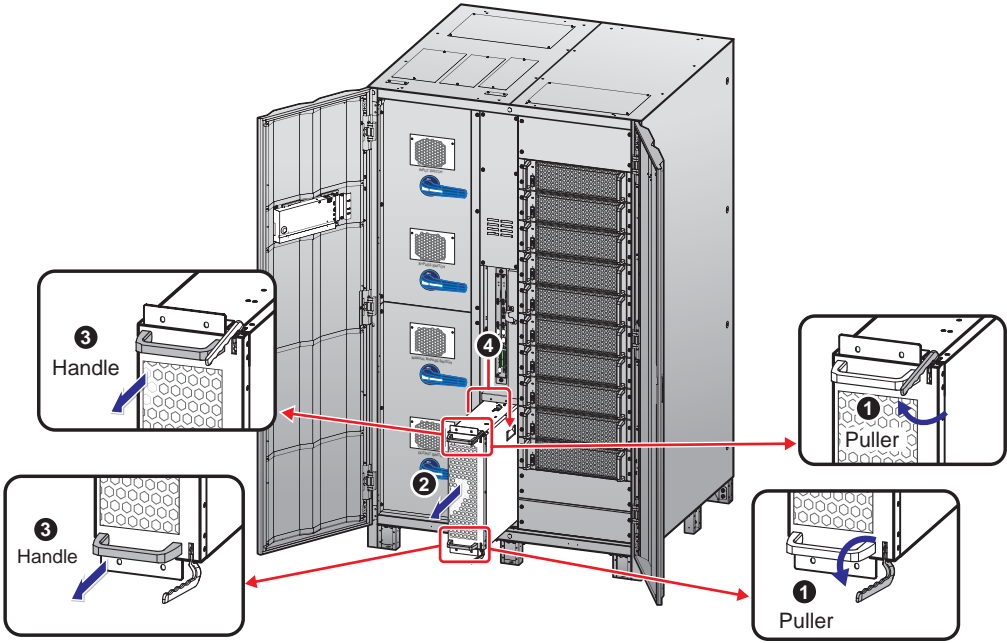

(Figure 5-29: Remove the STS Module from the UPS Cabinet)

(STS Module Left Side View)

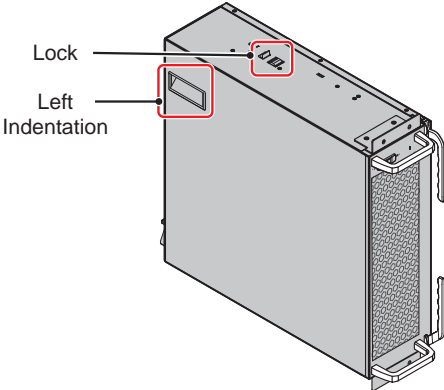

(STS Module Right Side View)

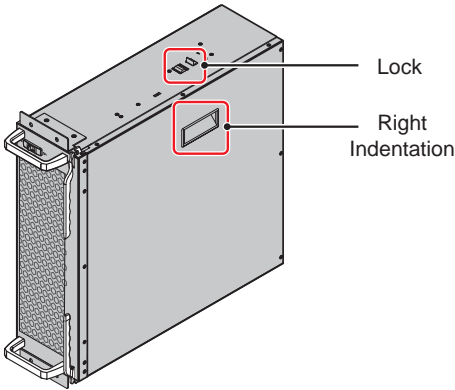

(Figure 5-30: Location of the Lock and Lateral Indentation)

5.7.3 STS Module's LED Indicator

The STS module's LED indicator shows its operation status. Please refer to the following table.

(STS Module Left Side View)

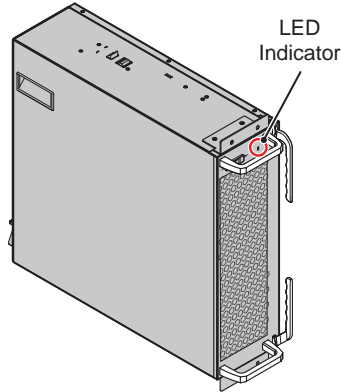

(Figure 5-31: Location of the STS Module's LED Indicator)

LED Indicator	Description
OFF	The STS module is OFF.
ON (yellow)	The STS module is working in bypass mode, ECO mode, or energy recycle mode.
Flashing (yellow)_ on for 0.3 second and off for 3 seconds	The STS module is abnormal.



NOTE:

In bypass mode, if you turn the STS module's switch to the lower position (), the STS module will shut down its output and its LED indicator will be off.

5.8 Power Module (Optional)

The power module is optional (not included in the package of the UPS). It is hot swappable and each capacity is 50kVA/ 50kW. Please follow your UPS capacity to install the correct number of power modules. Please refer to the table below.

UPS Capacity	200kVA/ 200kW	300kVA/ 300kW	400kVA/ 400kW	500kVA/ 500kW	600kVA/ 600kW
Power Module Q'ty	4	6	8	10	12

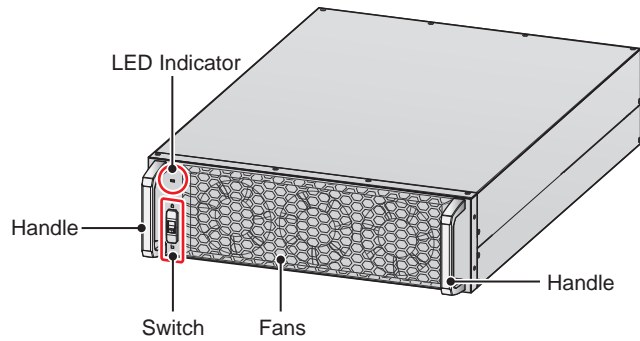

(Figure 5-32: Power Module (Optional))

Please see the table below for the power module's packing list.

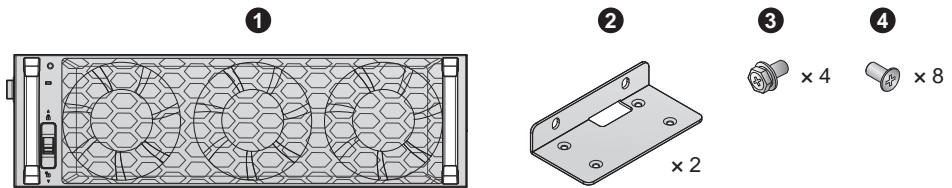

No.	Item	Q'ty
①	Power Module	1 PC
②	Bracket Ear	2 PCS
③	M6 Screw	4 PCS
④	M4 Screw	8 PCS

5.8.1 Power Module Installation

After firmly installing the UPS on the designated installation area according to the instructions stated in **5.4 UPS Installation**, continue with the following steps to install the power module (optional) into the UPS.



WARNING:

1. Only qualified service personnel can perform the following power module installation procedures.
2. The power module is heavy (> 36 kg (79.4 lb)). At least two people are required for handling.
3. Please follow your UPS capacity to install the correct number of power modules. Please refer to the table below.

UPS Capacity	200kVA/ 200kW	300kVA/ 300kW	400kVA/ 400kW	500kVA/ 500kW	600kVA/ 600kW
Power Module Q'ty	4	6	8	10	12

4. Please install the power modules from the top layer of the power module slot to the bottom layer of the power module slot in sequence.

- 1 Confirm the power module's switch is in the lower position ().

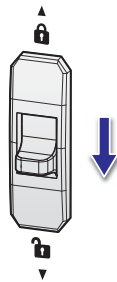

(Figure 5-33: Confirm the Power Module's Switch in the Lower Position)

- 2 Take out the two bracket ears, four M6 screws and eight M4 screws from the power module's package.
- 3 Use the provided eight M4 screws to fix the provided two bracket ears on the two sides of the power module. Please refer to **Figure 5-34**.

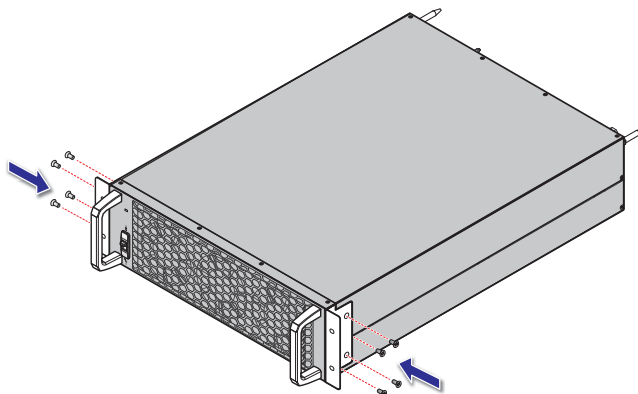

(Figure 5-34: Install the Two Bracket Ears)

- 4 Insert the power module into the unoccupied power module slot until it snaps into place. Two people are required.

**WARNING:**

Please install the power modules from the top layer of the power module slot to the bottom layer of the power module slot in sequence.

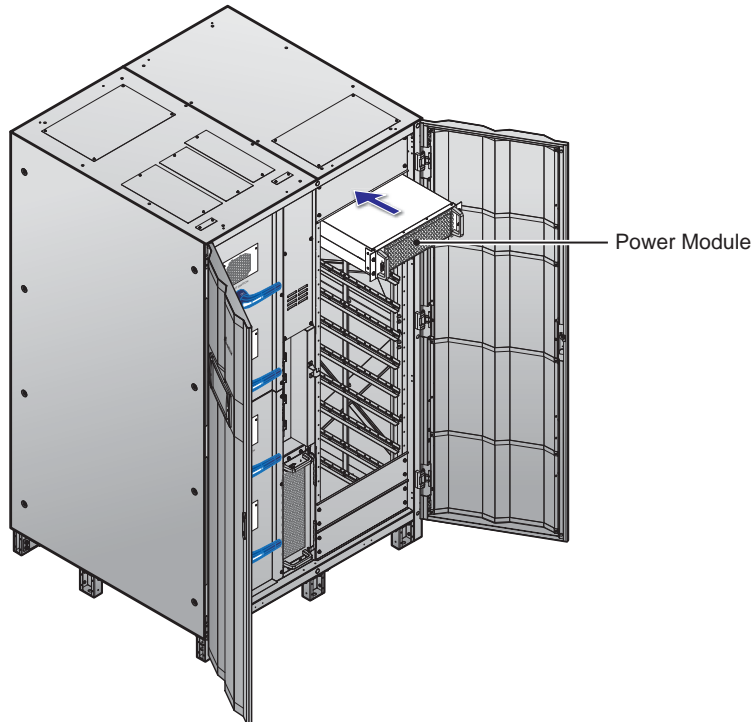

(Figure 5-35: Insert the Power Module into the UPS)

- 5 Use the provided four M6 screws to firmly fix the power module on the UPS cabinet.

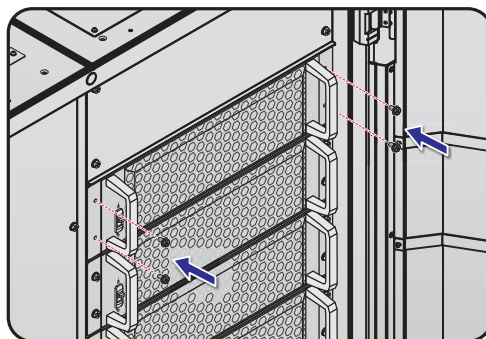

(Figure 5-36: Fix the Power Module on the UPS)

- 6 Turn the power module's switch to the upper position ().

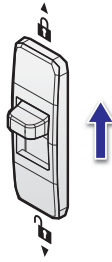

(Figure 5-37: Turn the Power Module's Switch to the Upper Position)

5.8.2 Power Module Removal



WARNING:

1. Before removing any power module, make sure that the remaining power module(s) can support the connected critical loads.
2. Only qualified service personnel can perform the following power module removal procedures.
3. The power module is heavy (> 36 kg (79.4 lb)). At least two people are required for handling.

- 1 Turn the power module's switch to the lower position (). After that, the power module will start discharging. After discharging, the power module's LED indicator will be off.

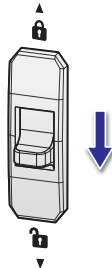

(Figure 5-38: Turn the Power Module's Switch in the Lower Position)

- 2 Use a screwdriver to remove the four screws from the power module shown in **Figure 5-39**.

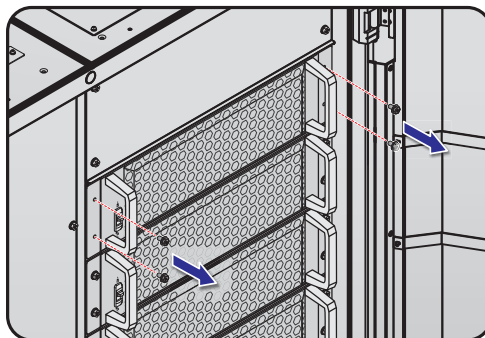

(Figure 5-39: Remove the Four Screws)

- 3 Pull out the power module from the slot (two people are required) (see **Figure 5-40**). When the power module cannot be pulled out any more, press the lock (see **Figure 5-41**) on the left side of the power module to continuously pull it out from the UPS cabinet.

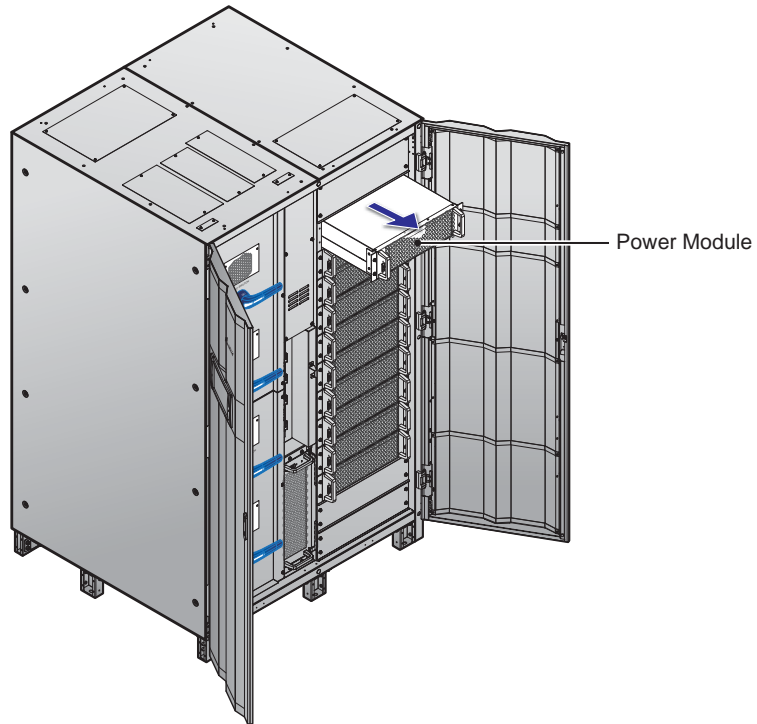

(Figure 5-40: Remove the Power Module)

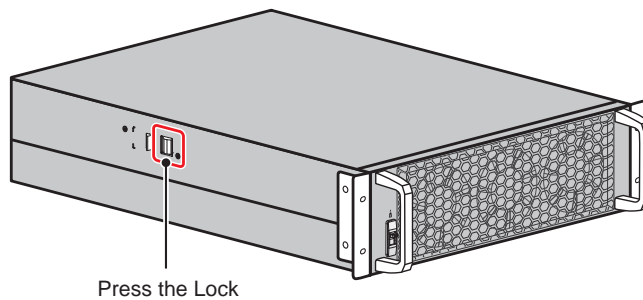

(Figure 5-41: Press the Lock of the Power Module)

5.8.3 Power Module's LED Indicator

The power module's LED indicator shows its operation status. Please refer to the following table.

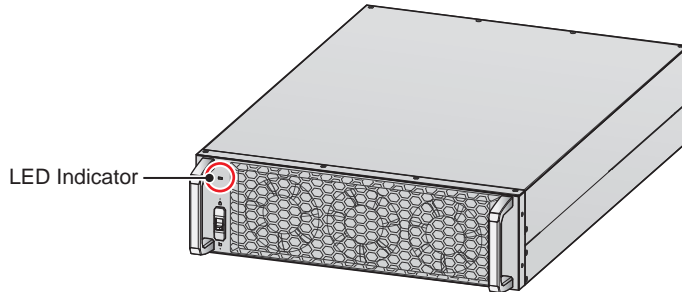

(Figure 5-42: Power Module's LED Indicator)

LED Indicator	Description
OFF	The power module is OFF.
ON (green)	<ol style="list-style-type: none"> 1. The power module is running in online mode or battery mode. 2. The power module's inverter starts up. 3. The power module's PFC starts up.
Flashing (green)_ on for 2 seconds and off for 1 second	The power module is under discharging process.
Flashing (green)_ on for 0.3 second and off for 3 seconds	The power module is abnormal.



NOTE:

In online mode, if you turn the power module's switch into the lower position (), the power module will shut down its output and discharge the DC BUS voltage until the voltage reaches to a safety level. After that, the power module's LED indicator will be off.

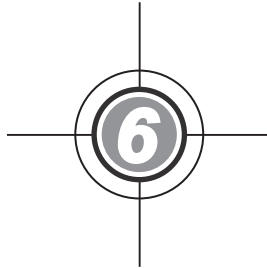

UPS Operation

- 6.1 Pre Start-up & Pre Turn-off Warnings for Single Unit and Parallel Units
- 6.2 Start-up Procedures
- 6.3 Turn-off Procedures



6.1 Pre Start-up & Pre Turn-off Warnings for Single Unit and Parallel Units



NOTE:

1. All unit No., UPS status, date, time, warning No., event No., load (%), battery remaining time, user login, administrator login, etc. shown in the LCD diagrams presented in **6. UPS Operation** are for reference only. Actual readings depend on the operation of the UPS.
2. In this user manual, the meaning of Q1, Q2, Q3, Q4 and Q5 represents the following.

Code	Meaning
Q1	Input Switch
Q2	Bypass Switch
Q3	Manual Bypass Switch
Q4	Output Switch
Q5	External Battery Cabinet's Breaker

3. Before operation, ensure that installation and wiring have been completely done according to **5. Installation and Wiring**, and relevant instructions have been followed.
4. Before operation, please refer to **2.8 Tri-color LED Indicator & Buzzer** and **7. LCD Display & Settings**.
5. (1) The setting of the **On/ Off Button Access** is set as 'Any User' for all the **ON/ OFF Button** () presented in this user manual.
 (2) If you want to change the access setting for the **ON/ OFF Button** (), please go to  → **General Setting** → **User** → **On/ OFF Button Access**. For relevant information, please refer to **7.10.7 General Setting**.

Single Unit

• Pre Start-up Warnings for Single Unit

1. Make sure that all the switches and breakers, including every external battery cabinet's breaker (Q5), are turned to the **OFF** position.
2. Make sure that the UPS's voltage difference between the Neutral (N) and Ground () is < 3V.



3. Check if the wiring is correct. Ensure that the AC power's voltage, frequency, phase sequence and battery type meet the UPS's requirements.
4. Check if all power modules are properly installed and every power module's switch is in the upper position (). Please refer to **5.8 Power Module (Optional)** for more information.

- **Pre Turn-off Warnings for Single Unit**

If you perform turn-off procedures for single unit, all power will be completely cut off. Please make sure the critical loads connected to the UPS have already been safely shut down before you perform the turn-off procedures.

Parallel Units

- **Pre Start-up Warnings for Parallel Units**

1. You can parallel eight UPS units at maximum.
2. For parallel units, ensure that each parallel cable (provided) is connected well.
3. Make sure that all switches and breakers, including every external battery cabinet's breaker (Q5), are turned to the **OFF** position.
4. Make sure that each parallel UPS's voltage difference between the Neutral (N) and Ground () is < 3V.
5. Check if the wiring is correct. Ensure that the AC power's voltage, frequency, phase sequence and battery type meet the UPS's requirements.
6. Check if all power modules are properly installed and every power module's switch is in the upper position (). Please refer to **5.8 Power Module (Optional)** for more information.
7. For parallel units, ensure that every operation procedure is synchronized to all parallel UPSs.
8. For parallel application, if you just want to operate a specific UPS but not all parallel ones, please contact service personnel.

- **Pre Turn-off Warnings for Parallel Units**

1. If you want to turn off one of the parallel UPSs, please check whether the remaining parallel units' total capacity exceeds the total critical loads. If the remaining parallel units' total capacity is less than the total critical loads, all parallel units will shut down due to overload.
2. If you perform turn-off procedures for all parallel UPSs, all power will be completely cut off. Please make sure that the critical loads connected to the parallel UPSs have already been safely shut down before you perform the turn-off procedures.

6.2 Start-up Procedures

6.2.1 On-Line Mode Start-up Procedures



WARNING:

1. For parallel units, please follow **6.2.3 Bypass Mode Start-up Procedures** to turn on each parallel UPS. After confirming that parallel operation works normally, follow the procedures below step by step.
2. For parallel units, ensure that every operation procedure mentioned below is synchronized to all parallel UPSs.
3. For parallel application, if you just want to operate a specific UPS but not all parallel ones, please contact service personnel.

- ① Ensure that the Manual Bypass Switch (Q3) is in the **OFF** position.
- ② Switch **ON** every external battery cabinet's breaker (Q5).
- ③ Switch **ON** the Input Switch (Q1), Bypass Switch (Q2) and Output Switch (Q4).
- ④ After you switch on the Input Switch (Q1) and Bypass Switch (Q2), each auxiliary power card's LED indicator will illuminate green and the following status will occur simultaneously.
 - (1) The system and each power module will start initialization. After each power module finishes initialization, each power module's fans will start running, each power module will start establishing DC BUS voltage and each power module's LED indicator will illuminate green.
 - (2) Each parallel communication card's LED indicator will illuminate red first and then each card will start initialization. After initialization, the master parallel communication card's LED indicator will illuminate green and the backup communication card's LED indicator will illuminate yellow.

For the locations of the parallel communication cards, auxiliary power cards, power modules and their LED indicators, please refer to **Figure 6-1**.

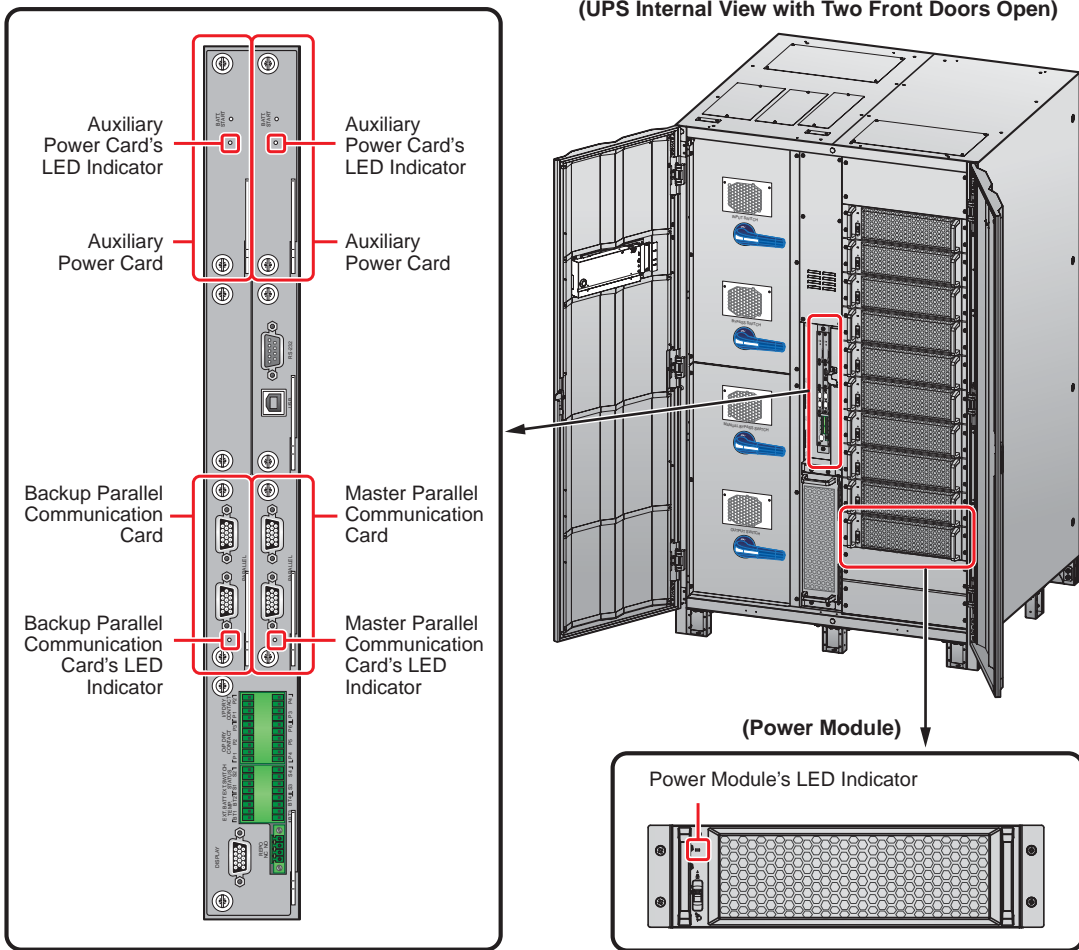

(Figure 6-1: The Locations of the Parallel Communication Cards, Auxiliary Power Cards, Power Modules and their LED Indicators)

- 5) The LCD initial screen (see **Figure 6-2**) will appear within 40 seconds after the Input Switch (Q1) and Bypass Switch (Q2) are turned on.



(Figure 6-2: LCD Initial Screen)

- 6 After 20 seconds of LCD initialization, the LCD will enter the **Main Screen**. For the **Main Screen** information, please refer to **7.6 Main Screen**.

Now, each power module keeps running and its LED indicator remains green. After each power module finishes establishing DC BUS voltage, the charger will start to charge the batteries.

If the bypass AC source is within the normal range, the UPS will transfer to run in Bypass mode, the LCD screen will show as **Figure 6-3** and the tri-color LED indicator will illuminate yellow.

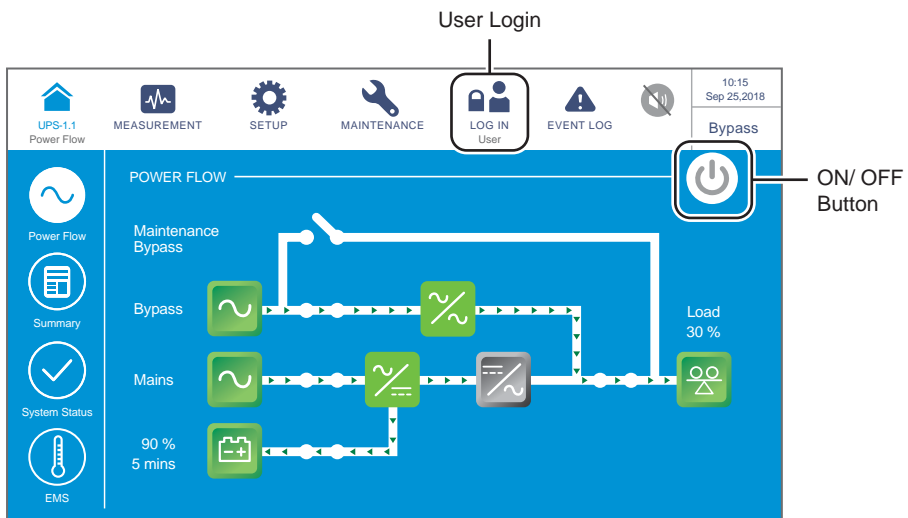

(Figure 6-3: Main Screen_ User Login & ON/ OFF Button Location)

- 7 Tap the ON/ OFF Button () and the following screen will pop up to ask if you want to power on the UPS's inverter. Please select 'YES'.

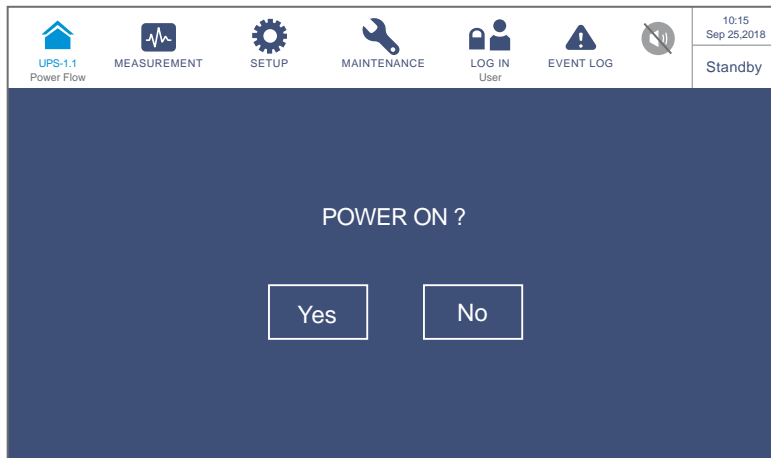

(Figure 6-4: Power on Reminder Screen)

- 8 After selection of 'YES' to start up the UPS's inverter, each power module will start up and perform self-inspection. At the same time, the system begins synchronization with the bypass AC source. After the self-inspection is completed, the UPS will automatically transfer to run in On-Line mode, the tri-color LED indicator will illuminate green and the following screen will appear.

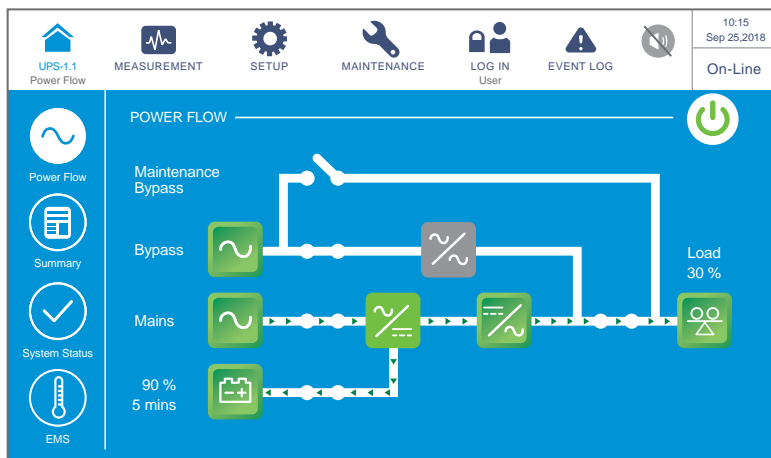

(Figure 6-5: On-Line Mode Screen)

6.2.2 Battery Mode Start-up Procedures



WARNING:

1. For parallel units, please follow **6.2.3 Bypass Mode Start-up Procedures** to turn on each parallel UPS. After confirming that parallel operation works normally, follow the procedures below step by step.
2. For parallel units, ensure that every operation procedure mentioned below is synchronized to all parallel UPSs.
3. For parallel application, if you just want to operate a specific UPS but not all parallel ones, please contact service personnel.

- 1 Ensure that the Manual Bypass Switch (Q3) is in the **OFF** position.
- 2 Switch **ON** every external battery cabinet's breaker (Q5).
- 3 Switch **ON** the Output Switch (Q4).
- 4 Press any of the **BATT. START** buttons (see **Figure 7-2**) for one second and release it. After that, each auxiliary power card's LED indicator will illuminate green and the following status will occur simultaneously.
 - (1) The system and each power module will start initialization. After each power module finishes initialization, each power module's fans will start running.
 - (2) Each parallel communication card's LED indicator will illuminate red first and then each card will start initialization. After initialization, the master parallel communication card's LED indicator will illuminate green and the backup communication card's LED indicator will illuminate yellow.

For the locations of the parallel communication cards, auxiliary power cards, power modules and their LED indicators, please refer to **Figure 6-1**.

- 5 The LCD initial screen (see **Figure 6-6**) will appear within 40 seconds after each auxiliary power card's LED indicator illuminates green.



(Figure 6-6: LCD Initial Screen)

- 6 After 20 seconds of LCD initialization, the LCD will enter the **Main Screen** shown in **Figure 6-7** and the tri-color LED indicator will illuminate yellow.

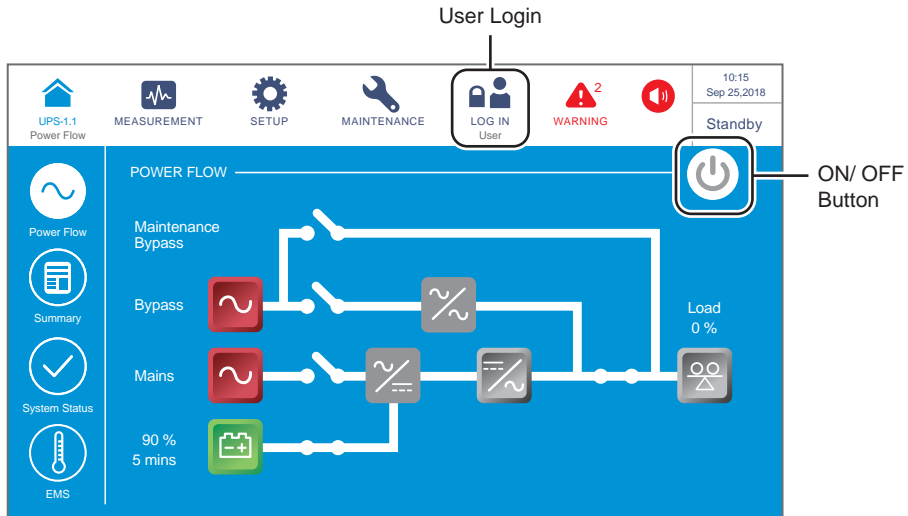

(Figure 6-7: Main Screen_ User Login & ON/ OFF Button Location)

- 7 Tap the ON/ OFF Button () and the following screen will pop up to ask if you want to power on the UPS. Please select 'YES'.

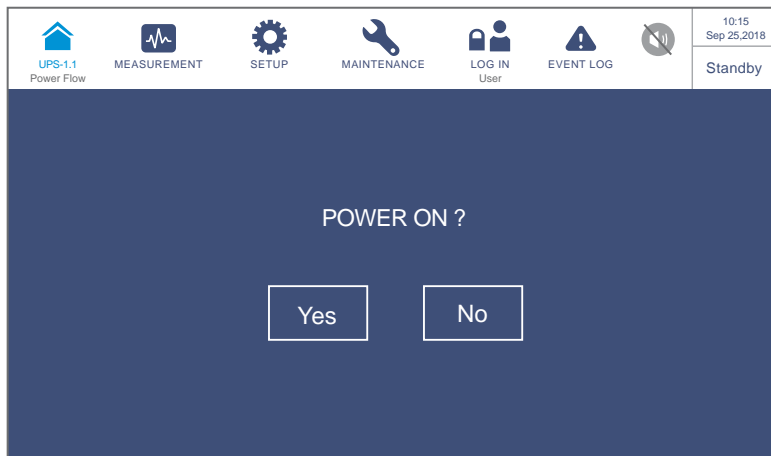

(Figure 6-8: Power on Reminder Screen)

- 8 After selection of 'YES' to start up the UPS's inverter, each power module will start up and perform self-inspection and the LED indicator of the power module will illuminate green. After the self-inspection is completed, the UPS will automatically transfer to run in Battery mode. At this moment, the tri-color LED indicator illuminates yellow and the following screen appears.

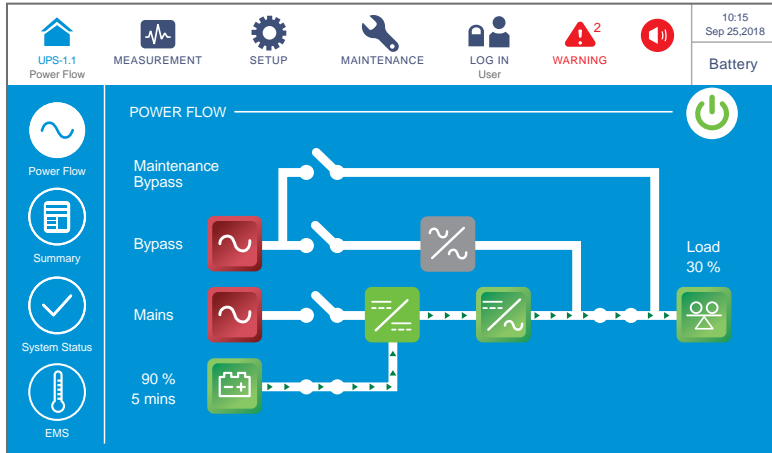

(Figure 6-9: Battery Mode Screen)

6.2.3 Bypass Mode Start-up Procedures



WARNING:

1. For parallel units, ensure that every operation procedure mentioned below is synchronized to all parallel UPSs.
2. For parallel application, if you just want to operate a specific UPS but not all parallel ones, please contact service personnel.

- ① Ensure that the Manual Bypass Switch (Q3) is in the **OFF** position.
- ② Switch **ON** every external battery cabinet's breaker (Q5).
- ③ Switch **ON** the Input Switch (Q1) and Bypass Switch (Q2).
- ④ After you switch on the Input Switch (Q1) and Bypass Switch (Q2), each auxiliary power card's LED indicator will illuminate green and the following status will occur simultaneously.
 - (1) The system and each power module will start initialization. After each power module finishes initialization, each power module's fans will start running, each power module will start establishing DC BUS voltage and each power module's LED indicator will illuminate green.
 - (2) Each parallel communication card's LED indicator will illuminate red first and then each card will start initialization. After initialization, the master parallel communication card's LED indicator will illuminate green and the backup communication card's LED indicator will illuminate yellow.

For the locations of the parallel communication cards, auxiliary power cards, power modules and their LED indicators, please refer to **Figure 6-1**.

- 5 The LCD initial screen (see **Figure 6-10**) will appear within 40 seconds after the Input Switch (Q1) and Bypass Switch (Q2) are turned on.



(Figure 6-10: LCD Initial Screen)

- 6 After 20 seconds of LCD initialization, the LCD will enter the **Main Screen**. For the **Main Screen** information, please refer to **7.6 Main Screen**.

Now, each power module keeps running and its LED indicator remains green. After each power module finishes establishing DC BUS voltage, the charger will start to charge the batteries.

If the bypass AC source is within the normal range, the UPS will transfer to run in Bypass mode, the LCD screen will show as **Figure 6-11** and the tri-color LED indicator will illuminate yellow.

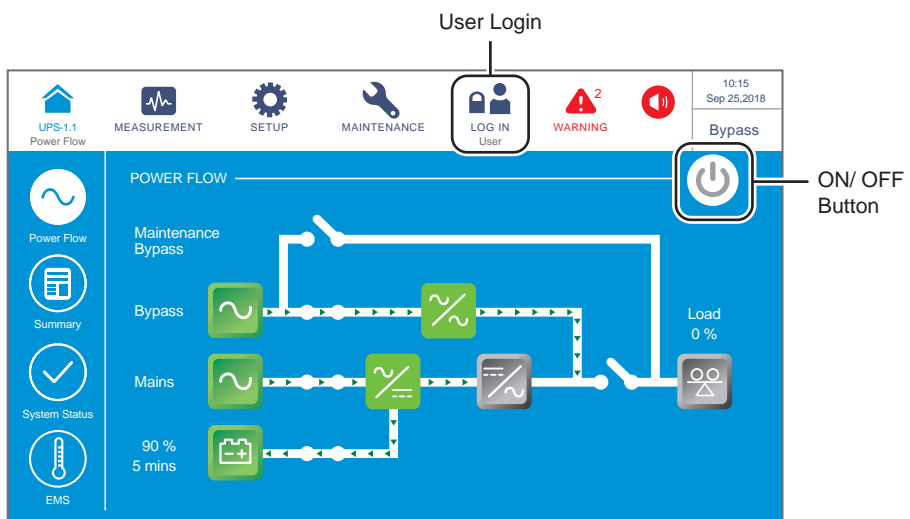

(Figure 6-11: Main Screen_ User Login & ON/ OFF Button Location)

- 7 For parallel application, please check each parallel UPS's parallel settings. Please note that each parallel UPS's parallel ID No. must be different, and parallel group ID No., input, output and battery settings must be the same.
- 8 For parallel application, tap the icon () located in the upper left corner of the screen and check if the parallel group ID No. and parallel ID No. of the parallel UPSs are correct. The UPS with the smallest parallel ID No. is defined as the master unit. Please refer to **Figure 6-12**.

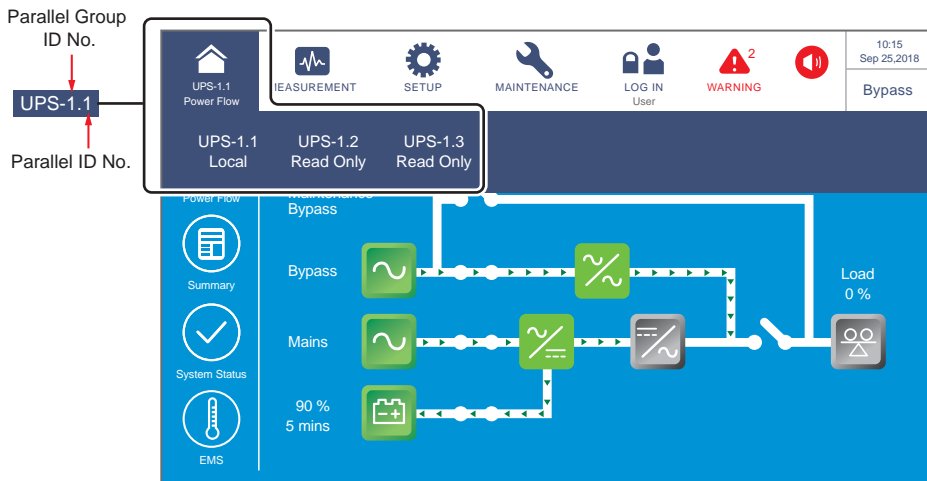

(Figure 6-12: Parallel Group ID No. & Parallel ID No. Inquiry Screen)

- 9 For single unit, turn **ON** the Output Switch (Q4).
 For parallel units, ensure that the output voltage difference between each parallel UPS is below 3V. If larger than 3V, it is abnormal; please contact service personnel immediately. If below 3V, turn **ON** each parallel UPS's Output Switch (Q4).
 Now, the tri-color LED indicator illuminates yellow and the LCD shows the following screen (see **Figure 6-13**).

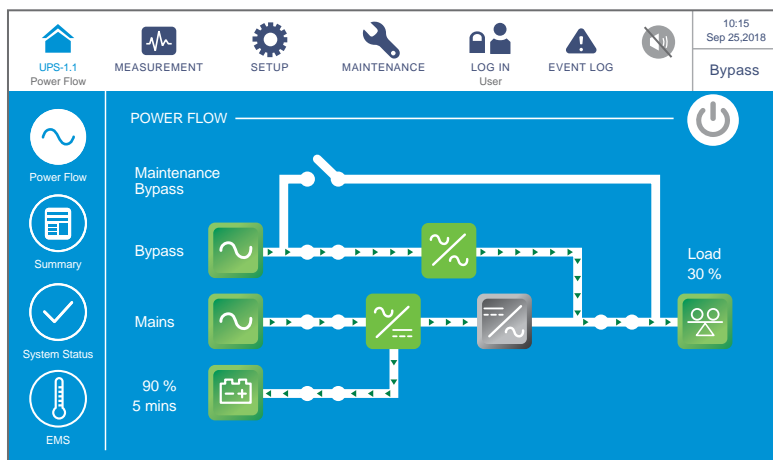

(Figure 6-13: Bypass Mode Screen)

6.2.4 Manual Bypass Mode Start-up Procedures



WARNING:

1. For parallel units, ensure that every operation procedure mentioned below is synchronized to all parallel UPSs.
2. For parallel application, if you just want to operate a specific UPS but not all parallel ones, please contact service personnel.
3. Please note that you can turn on the Manual Bypass Switch (Q3) only when the UPS needs maintenance. In Manual Bypass mode, power supply of the connected critical loads comes from the manual bypass and the output is not protected. Please ensure that the bypass AC source is normal.
4. In Manual Bypass mode, power supply of the critical loads comes from the manual bypass; thus, maintenance personnel can perform maintenance without interrupting the power supplying to the critical loads.
5. Ensure that all of the switches and breakers (except the Manual Bypass Switch (Q3)) are in the **OFF** position, and use a voltmeter to check if there is any high voltage inside the UPS. Only after you have confirmed that there is no high voltage in the UPS can service personnel perform UPS maintenance.
6. During the UPS maintenance process, do not touch the following parts: AC Input terminal block, Bypass Input terminal block, UPS Output terminal block, Battery Input terminal block, grounding terminals (see **Figure 5-8 ~ Figure 5-10** for the location of these terminal blocks and terminals) and any copper bars connected to the Manual Bypass Switch (Q3), as they may carry high voltage.

• From On-Line Mode to Manual Bypass Mode

- 1 In On-Line mode, the LCD's main screen shows as follows and the tri-color LED indicator illuminates green.

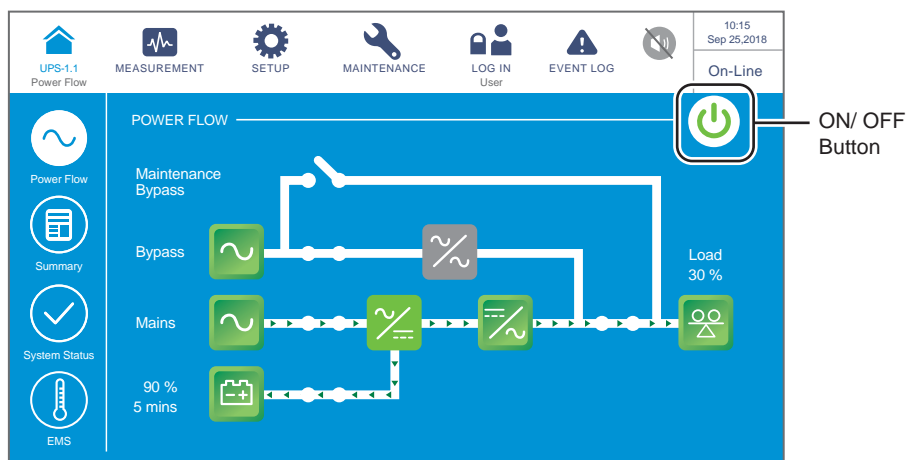

(Figure 6-14: On-Line Mode Screen_ User Login & ON/ OFF Button Location)

- 2) Check if the bypass voltage and STS module are normal or not.
- 3) If normal, tap the ON/ OFF Button () and the following screen will pop up to ask if you want to power off the UPS's inverter.

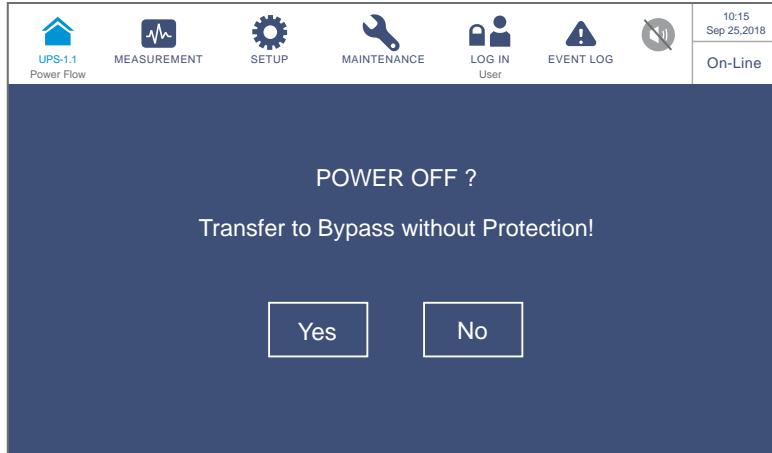

(Figure 6-15: Power off Reminder Screen)

- 4) If normal, please select 'YES'. After that, the UPS will shut down the inverter and transfer to run in Bypass mode.
- 5) Ensure that the UPS runs in Bypass mode. After confirmation, turn **ON** the Manual Bypass Switch (Q3).
- 6) Switch **OFF** the Input Switch (Q1), Bypass Switch (Q2) and Output Switch (Q4). After that, the screen shows as follows.

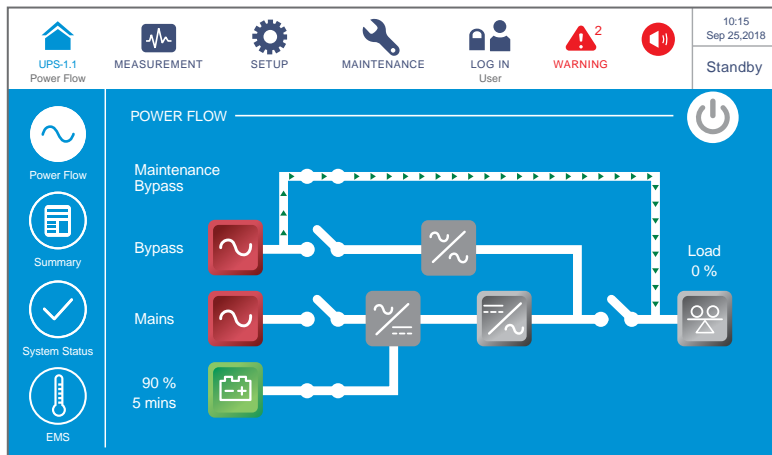

(Figure 6-16: On-Line Mode to Manual Bypass Mode Screen)

- 7 When the UPS performs DC BUS discharging, each power module's LED indicator flashes green. After discharging, each power module's LED indicator will be off.
- 8 About three minutes later, the UPS will shut down, and the LCD and the tri-color LED will be off.
- 9 Switch **OFF** every external battery cabinet's breaker (Q5).

- **From Manual Bypass Mode to Online Mode**



WARNING:

1. For parallel units, please follow **6.2.3 Bypass Mode Start-up Procedures** to turn on each parallel UPS. After confirming that parallel operation works normally, follow the procedures below step by step.
2. For parallel units, ensure that every operation procedure mentioned below is synchronized to all parallel UPSs.
3. For parallel application, if you just want to operate a specific UPS but not all parallel ones, please contact service personnel.

- 1 Switch **ON** every external battery cabinet's breaker (Q5).
- 2 Switch **ON** the Input Switch (Q1), Bypass Switch (Q2) and Output Switch (Q4).
- 3 After you switch on the Input Switch (Q1) and Bypass Switch (Q2), each auxiliary power card's LED indicator will illuminate green and the following status will occur simultaneously.
 - (1) The system and each power module will start initialization. After each power module finishes initialization, each power module's fans will start running, each power module will start establishing DC BUS voltage and each power module's LED indicator will illuminate green.
 - (2) Each parallel communication card's LED indicator will illuminate red first and then each card will start initialization. After initialization, the master parallel communication card's LED indicator will illuminate green and the backup communication card's LED indicator will illuminate yellow.

For the locations of the parallel communication cards, auxiliary power cards, power modules and their LED indicators, please refer to **Figure 6-1**.

- 4 The LCD initial screen (see **Figure 6-17**) will appear within 40 seconds after the Input Switch (Q1) and Bypass Switch (Q2) are turned on.



(Figure 6-17: LCD Initial Screen)

- 5 After 20 seconds of LCD initialization, the LCD will enter the **Main Screen**. For the **Main Screen** information, please refer to **7.6 Main Screen**.

Now, each power module keeps running and its LED indicator remains green. After each power module finishes establishing DC BUS voltage, the charger will start to charge the batteries.

If the bypass AC source is within the normal range, the UPS will transfer to run in Bypass mode, the LCD screen will show as **Figure 6-18** and the tri-color LED indicator will illuminate yellow.

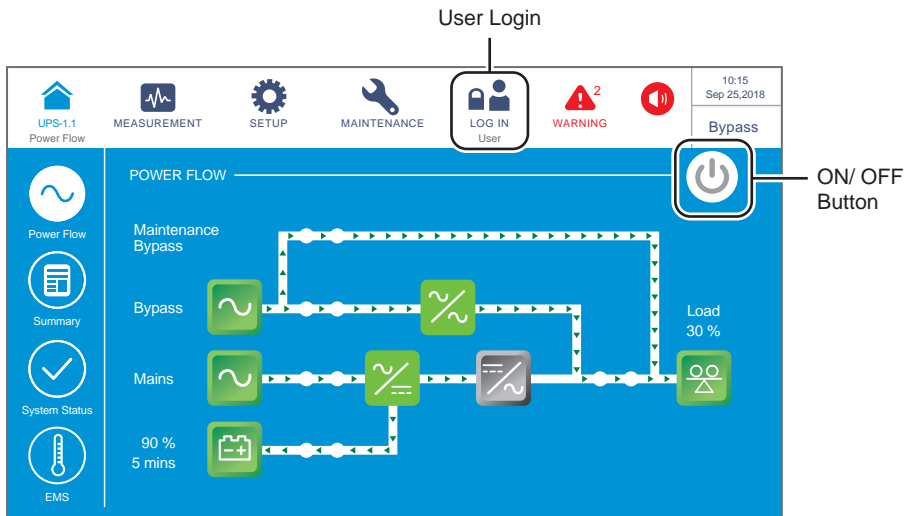

(Figure 6-18: Bypass Mode Screen_ User Login & ON/ OFF Button Location)

- 6 Switch **OFF** the Manual Bypass Switch (Q3).
- 7 Tap the ON/ OFF Button () and the following screen will pop up to ask if you want to power on the UPS's inverter. Please select 'YES'.

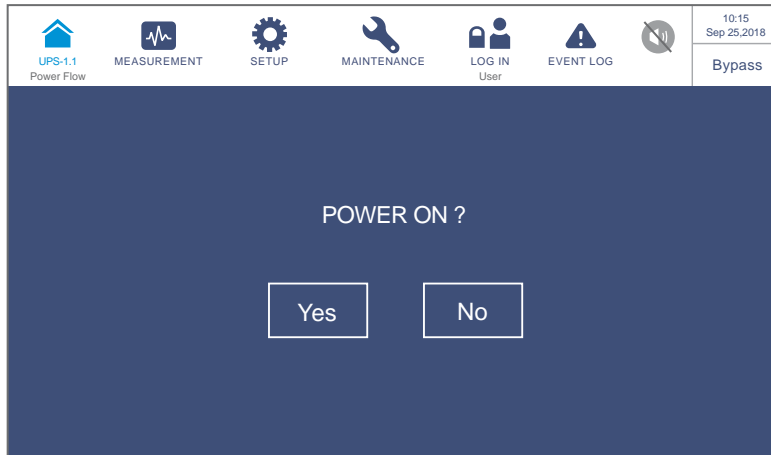

(Figure 6-19: Power on Reminder Screen)

- 8 After selection of 'YES' to start up the UPS's inverter, each power module will start up and perform self-inspection. At the same time, the system begins synchronization with the bypass AC source. After the self-inspection is completed, the UPS will automatically transfer to run in On-Line mode, the tri-color LED indicator will illuminate green and the following screen will appear.

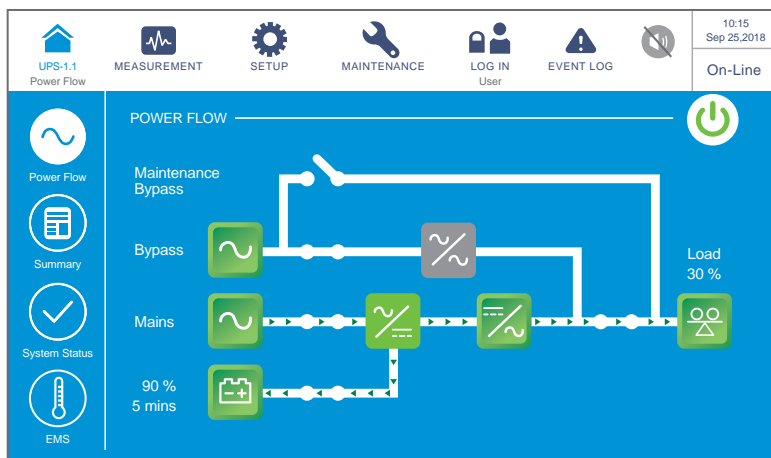

(Figure 6-20: On-Line Mode Screen)

6.2.5 ECO Mode Start-up Procedures



WARNING:

1. For parallel units, please follow **6.2.3 Bypass Mode Start-up Procedures** to turn on each parallel UPS. After confirming that parallel operation works normally, follow the procedures below step by step.
2. For parallel units, ensure that every operation procedure mentioned below is synchronized to all parallel UPSs.
3. For parallel application, if you just want to operate a specific UPS but not all parallel ones, please contact service personnel.

- ① Ensure that the Manual Bypass Switch (Q3) is in the **OFF** position.
 - ② Switch **ON** every external battery cabinet's breaker (Q5).
 - ③ Switch **ON** the Input Switch (Q1), Bypass Switch (Q2) and Output Switch (Q4).
 - ④ After you switch on the Input Switch (Q1) and Bypass Switch (Q2), each auxiliary power card's LED indicator will illuminate green and the following status will occur simultaneously.
 - (1) The system and each power module will start initialization. After each power module finishes initialization, each power module's fans will start running, each power module will start establishing DC BUS voltage and each power module's LED indicator will illuminate green.
 - (2) Each parallel communication card's LED indicator will illuminate red first and then each card will start initialization. After initialization, the master parallel communication card's LED indicator will illuminate green and the backup communication card's LED indicator will illuminate yellow.
- For the locations of the parallel communication cards, auxiliary power cards, power modules and their LED indicators, please refer to **Figure 6-1**.
- ⑤ The LCD initial screen (see **Figure 6-21**) will appear within 40 seconds after the Input Switch (Q1) and Bypass Switch (Q2) are turned on.



(Figure 6-21: LCD Initial Screen)

- 6 After 20 seconds of LCD initialization, the LCD will enter the **Main Screen**. For the **Main Screen** information, please refer to **7.6 Main Screen**.

Now, each power module keeps running and its LED indicator remains green. After each power module finishes establishing DC BUS voltage, the charger will start to charge the batteries.

If the bypass AC source is within the normal range, the UPS will transfer to run in Bypass mode, the LCD screen will show as **Figure 6-22** and the tri-color LED indicator will illuminate yellow.

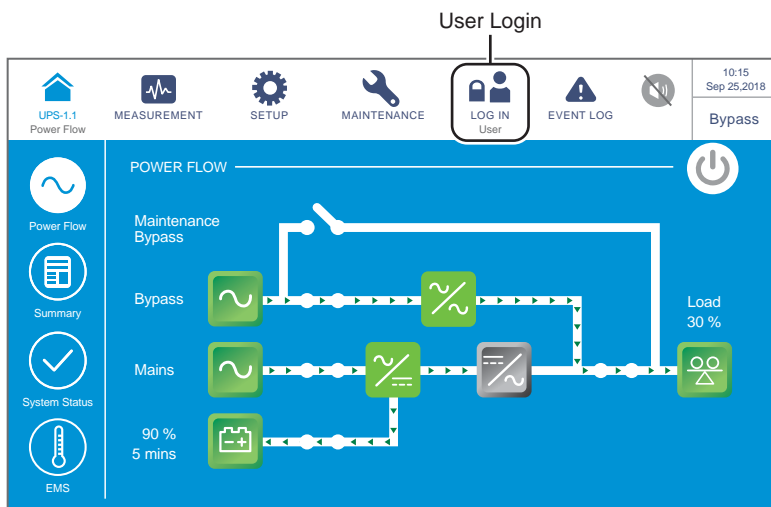

(Figure 6-22: Main Screen_ User Login)

- 7 Please log in as an **Administrator**. For the **Administrator** password, please contact service personnel. After login, ensure that you are in the **Administrator** login status (see **Figure 6-23**).

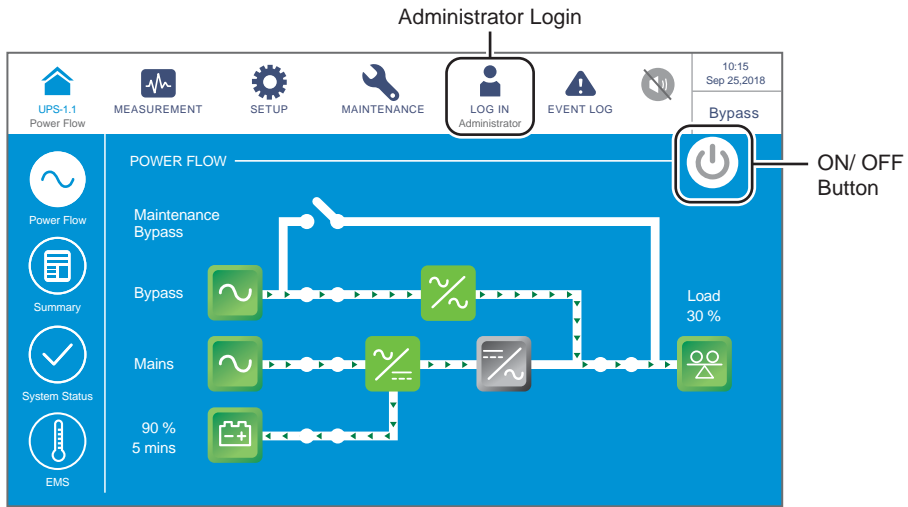

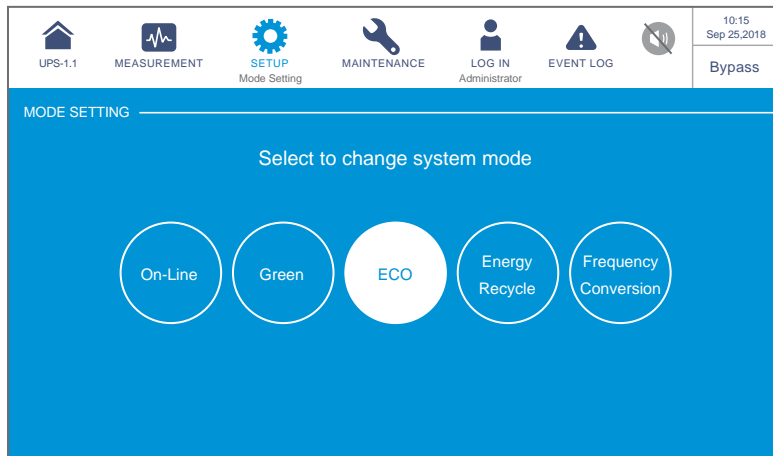

(Figure 6-23: Main Screen_ Administrator Login & ON/ OFF Button Location)

- 8 Go to **SETUP** → **Mode Setting** → **ECO**.



(Figure 6-24: Select ECO Mode)

- 9 After manually selecting **ECO** mode via the LCD, tap the icon () located in the upper left corner of the screen to go back to the **Main Screen**.

- 10 Tap the ON/ OFF Button () and the following screen will pop up to ask if you want to power on the UPS's inverter. Please select 'YES'.

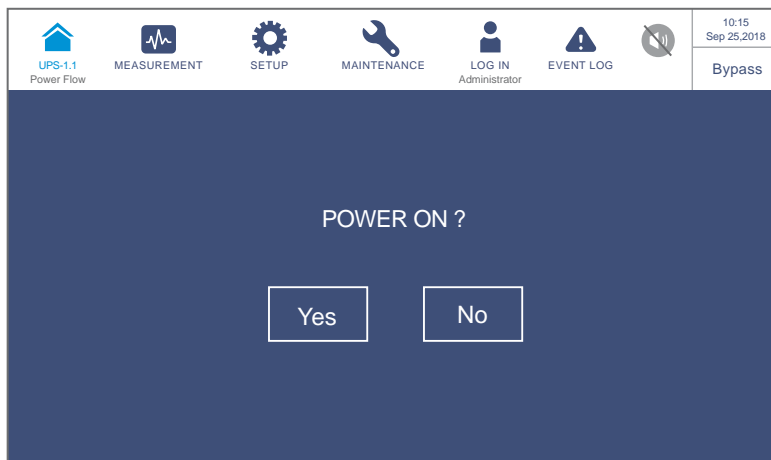

(Figure 6-25: Power on Reminder Screen)

- 11 After selection of 'YES' to start up the UPS's inverter, each power module will start up and perform self-inspection. At the same time, the system begins synchronization with the bypass AC source. After the self-inspection is completed, the UPS will automatically transfer to run in On-Line mode. After the system confirms that the bypass voltage is normal, the UPS will automatically switch to run in ECO mode to let the bypass AC source supply power (see **Figure 6-26**). Now, the tri-color LED indicator illuminates green and the following screen appears.

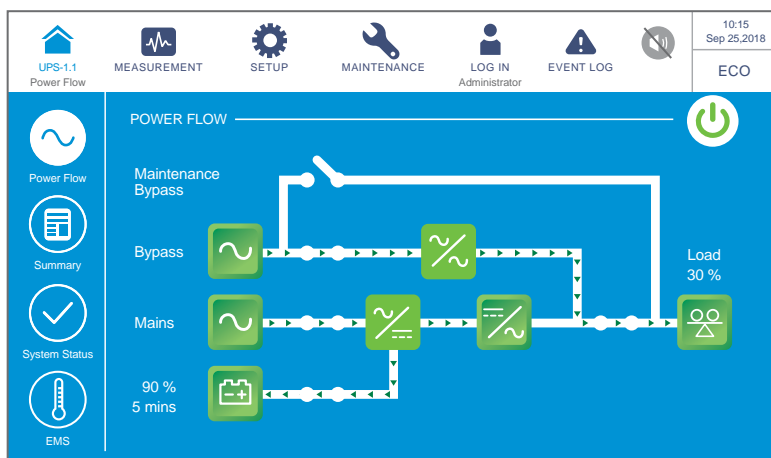

(Figure 6-26: ECO Mode Screen)

6.2.6 Frequency Conversion Mode Start-up Procedures



WARNING:

1. Frequency Conversion mode is only applicable to single UPS but not to parallel UPSs.
2. When the UPS runs in Frequency Conversion mode, once the inverter becomes off, there is no bypass power supplying to the loads.

- 1 Ensure that the Manual Bypass Switch (Q3) is in the **OFF** position.
- 2 Switch **ON** every external battery cabinet's breaker (Q5).
- 3 Switch **ON** the Input Switch (Q1), Bypass Switch (Q2) and Output Switch (Q4).
- 4 After you switch on the Input Switch (Q1) and Bypass Switch (Q2), each auxiliary power card's LED indicator will illuminate green and the following status will occur simultaneously.
 - (1) The system and each power module will start initialization. After each power module finishes initialization, each power module's fans will start running, each power module will start establishing DC BUS voltage and each power module's LED indicator will illuminate green.
 - (2) Each parallel communication card's LED indicator will illuminate red first and then each card will start initialization. After initialization, the master parallel communication card's LED indicator will illuminate green and the backup communication card's LED indicator will illuminate yellow.

For the locations of the parallel communication cards, auxiliary power cards, power modules and their LED indicators, please refer to **Figure 6-1**.

- 5 The LCD initial screen (see **Figure 6-27**) will appear within 40 seconds after the Input Switch (Q1) and Bypass Switch (Q2) are turned on.



(Figure 6-27: LCD Initial Screen)

- 6 After 20 seconds of LCD initialization, the LCD will enter the **Main Screen**. For the **Main Screen** information, please refer to **7.6 Main Screen**.

Now, each power module keeps running and its LED indicator remains green. After each power module finishes establishing DC BUS voltage, the charger will start to charge the batteries.

If the bypass AC source is within the normal range, the UPS will transfer to run in Bypass mode, the LCD screen will show as **Figure 6-28** and the tri-color LED indicator will illuminate yellow.

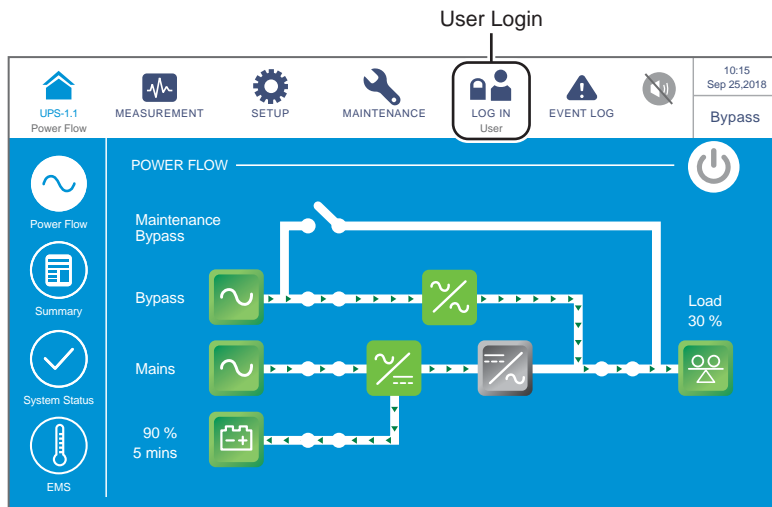

(Figure 6-28: Main Screen_ User Login)

- 7 Please log in as an **Administrator**. For the **Administrator** password, please contact service personnel. After login, ensure that you are in the **Administrator** login status (see **Figure 6-29**).

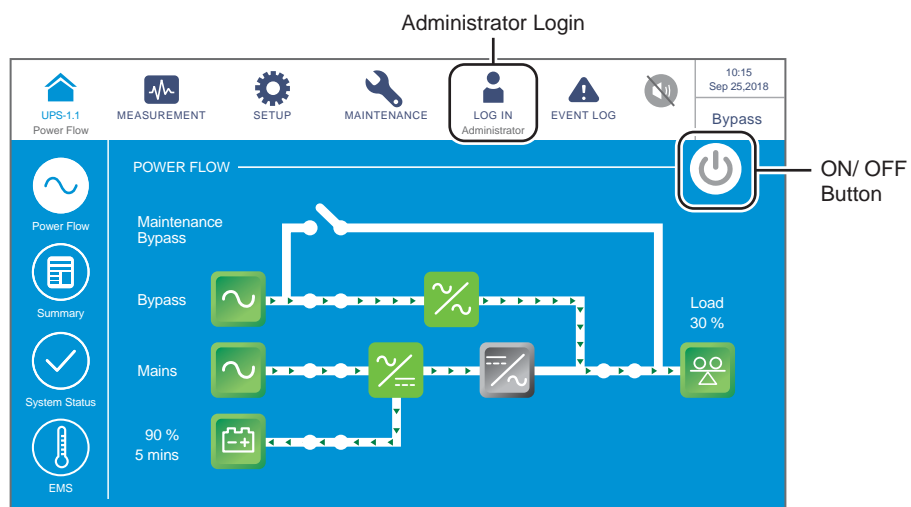

(Figure 6-29: Main Screen_ Administrator Login & ON/ OFF Button Location)

- 8 Go to **SETUP** → **Mode Setting** → **Frequency Conversion**.



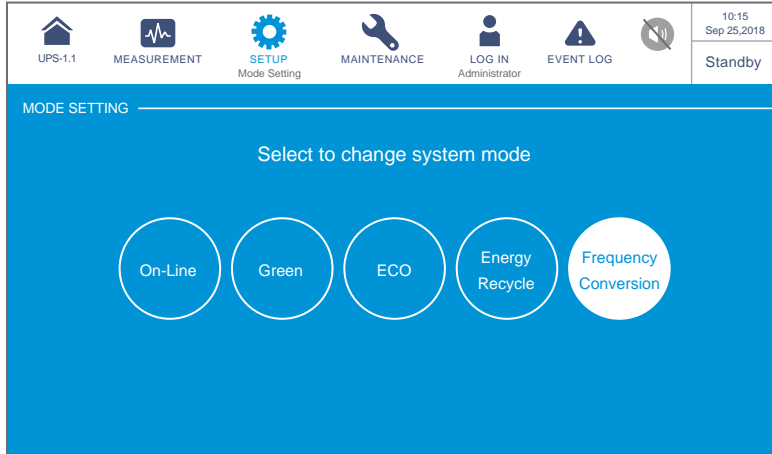

WARNING:

Please note that, once you select '**Frequency Conversion**' mode via the LCD, the UPS will run in Standby mode and the output will be terminated.



(Figure 6-30: Select Frequency Conversion Mode)

- 9 Tap the icon () located in the upper left corner of the screen to go back to the **Main Screen**.
- 10 Tap the ON/ OFF Button () and the following screen will pop up to ask if you want to power on the UPS's inverter. Please select '**YES**'.

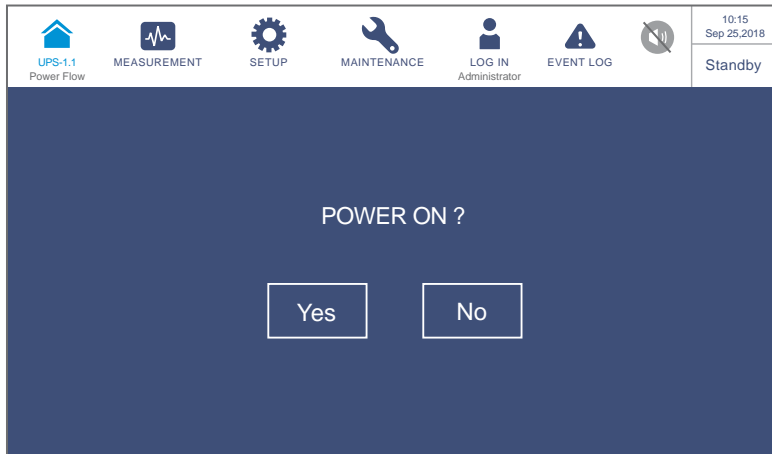

(Figure 6-31: Power on Reminder Screen)

- 11 After selection of '**YES**' to start up the UPS's inverter, each power module will start up and perform self-inspection. After the self-inspection is completed, the UPS will automatically transfer to run in Frequency Conversion mode and the output frequency will be the same as setup value. Now, the tri-color LED indicator illuminates green and the following screen appears.

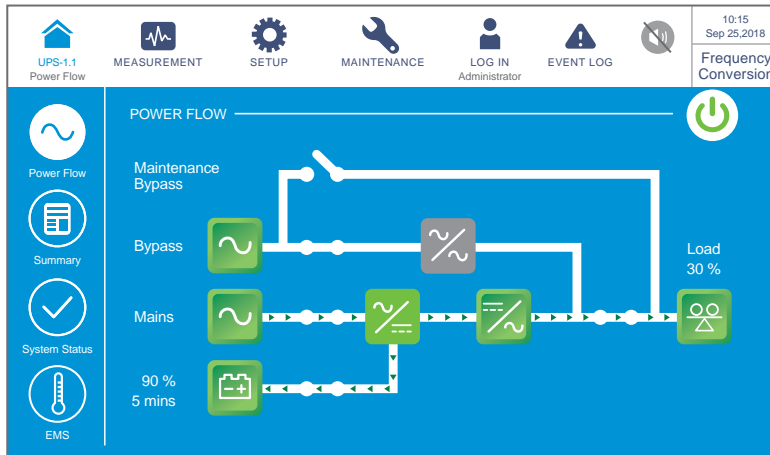

(Figure 6-32: Frequency Conversion Mode Screen)

6.2.7 Green Mode Start-up Procedures



WARNING:

1. For parallel units, please follow **6.2.3 Bypass Mode Start-up Procedures** to turn on each parallel UPS. After confirming that parallel operation works normally, follow the procedures below step by step.
2. For parallel units, ensure that every operation procedure mentioned below is synchronized to all parallel UPSs.
3. For parallel application, if you just want to operate a specific UPS but not all parallel ones, please contact service personnel.

- ① Ensure that the Manual Bypass Switch (Q3) is in the **OFF** position.
- ② Switch **ON** every external battery cabinet's breaker (Q5).
- ③ Switch **ON** the Input Switch (Q1), Bypass Switch (Q2) and Output Switch (Q4).
- ④ After you switch on the Input Switch (Q1) and Bypass Switch (Q2), each auxiliary power card's LED indicator will illuminate green and the following status will occur simultaneously.
 - (1) The system and each power module will start initialization. After each power module finishes initialization, each power module's fans will start running, each power module will start establishing DC BUS voltage and each power module's LED indicator will illuminate green.
 - (2) Each parallel communication card's LED indicator will illuminate red first and then each card will start initialization. After initialization, the master parallel communication card's LED indicator will illuminate green and the backup communication card's LED indicator will illuminate yellow.

For the locations of the parallel communication cards, auxiliary power cards, power modules and their LED indicators, please refer to **Figure 6-1**.

- 5 The LCD initial screen (see **Figure 6-33**) will appear within 40 seconds after the Input Switch (Q1) and Bypass Switch (Q2) are turned on.



(Figure 6-33: LCD Initial Screen)

- 6 After 20 seconds of LCD initialization, the LCD will enter the **Main Screen**. For the **Main Screen** information, please refer to **7.6 Main Screen**.

Now, each power module keeps running and its LED indicator remains green. After each power module finishes establishing DC BUS voltage, the charger will start to charge the batteries.

If the bypass AC source is within the normal range, the UPS will transfer to run in Bypass mode, the LCD screen will show as **Figure 6-34** and the tri-color LED indicator will illuminate yellow.

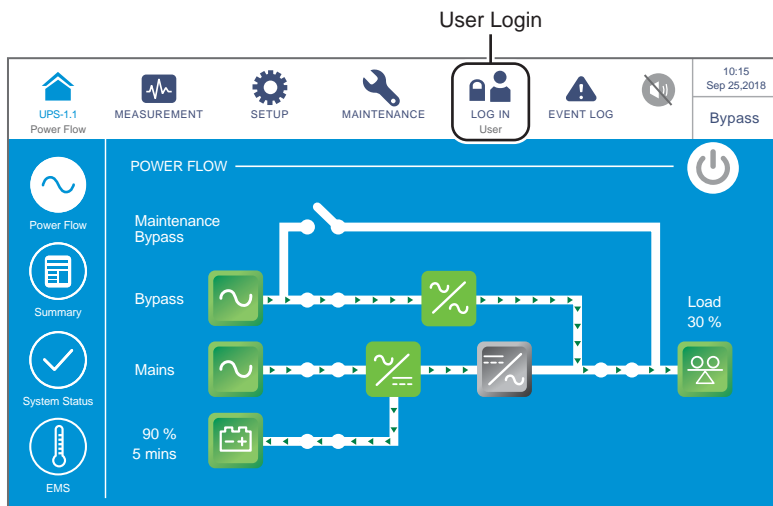

(Figure 6-34: Main Screen_ User Login)

- 7 Please log in as an **Administrator**. For the **Administrator** password, please contact service personnel. After login, ensure that you are in the **Administrator** login status (see **Figure 6-35**).

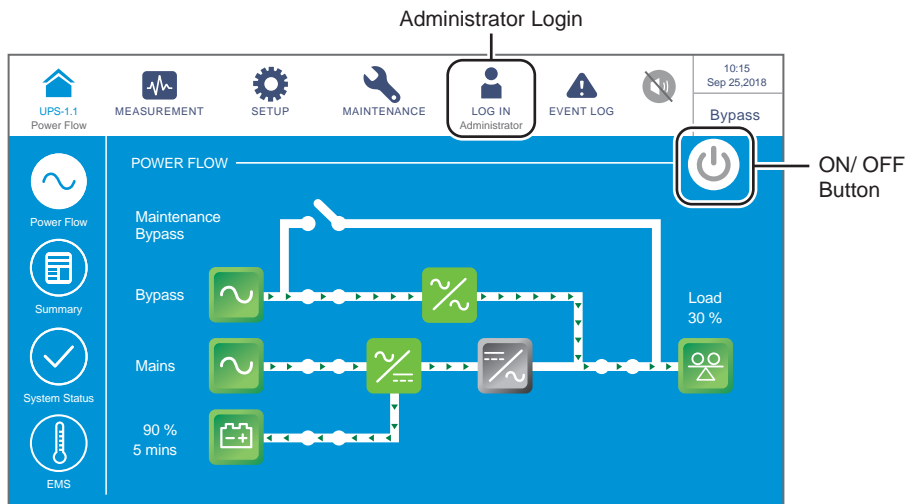

(Figure 6-35: Main Screen_ Administrator Login & ON/ OFF Button Location)

- 8 Go to **SETUP** → **Mode Setting** → **Green**.

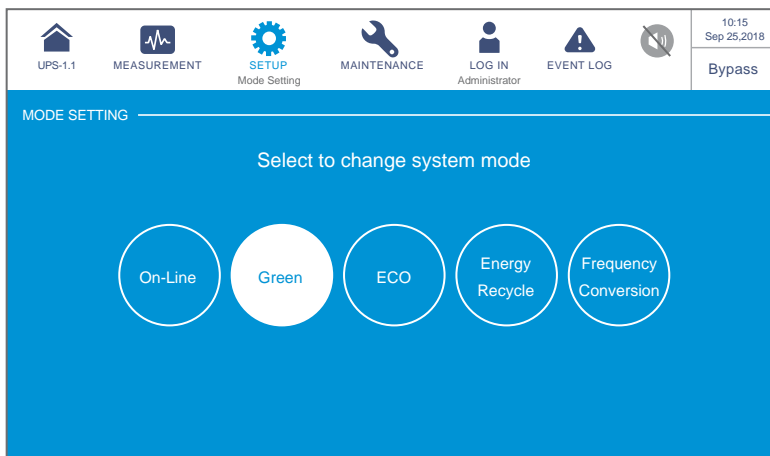

(Figure 6-36: Select Green Mode)

- 9 After manually selecting **Green** mode via the LCD, tap the icon () located in the upper left corner of the screen to go back to the **Main Screen**.

- 10 Tap the ON/ OFF Button (🔌) and the following screen will pop up to ask if you want to power on the UPS's inverter. Please select **'YES'**.

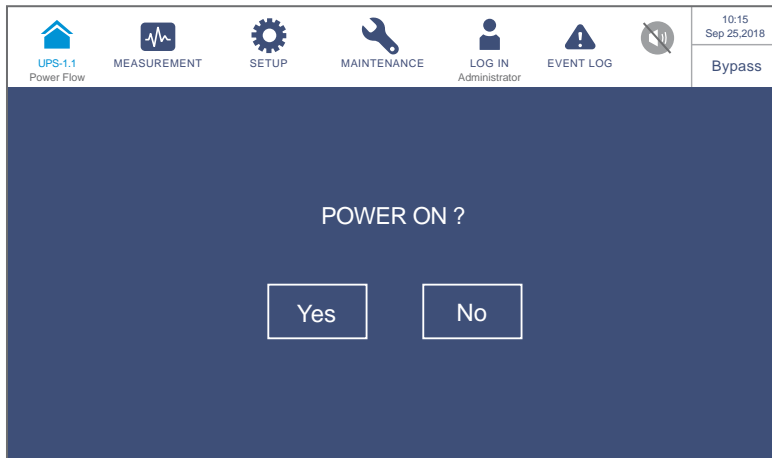

(Figure 6-37: Power on Reminder Screen)

- 11 After selection of **'YES'** to start up the UPS's inverter, each power module will start up and perform self-inspection. At the same time, the system begins synchronization with the bypass AC source. After the self-inspection is completed, the UPS will automatically transfer to run in Green mode and the system will automatically detect the output status (i.e. total load capacity %) to decide which specific power modules should be fully powered on or idle in order to achieve higher efficiency of the UPS. Now, the tri-color LED indicator illuminates green and the following screen appears.

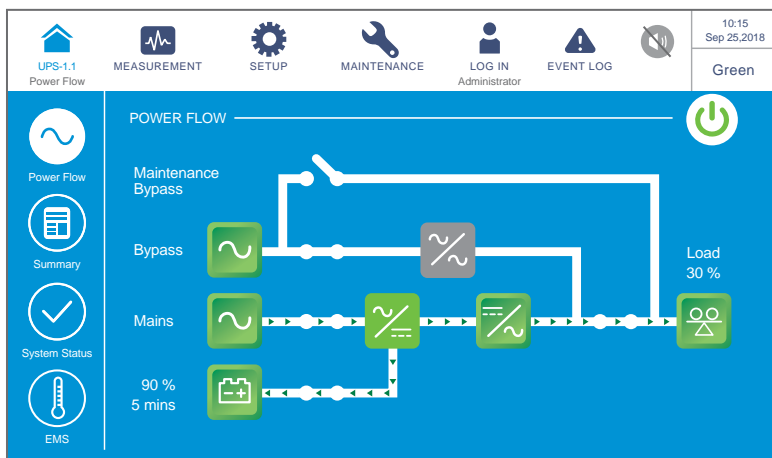

(Figure 6-38: Green Mode Screen)

6.2.8 Energy Recycle Mode Start-up Procedures



WARNING:

Energy Recycle mode is only applicable to single input and single unit application.

- 1) Ensure that the Manual Bypass Switch (Q3), Output Switch (Q4) and every external battery cabinet's breaker (Q5) are in the **OFF** position.
- 2) Switch **ON** the Input Switch (Q1) and Bypass Switch (Q2).
- 3) After you switch on the Input Switch (Q1) and Bypass Switch (Q2), each auxiliary power card's LED indicator will illuminate green and the following status will occur simultaneously.
 - (1) The system and each power module will start initialization. After each power module finishes initialization, each power module's fans will start running.
 - (2) Each parallel communication card's LED indicator will illuminate red first and then each card will start initialization. After initialization, the master parallel communication card's LED indicator will illuminate green and the backup communication card's LED indicator will illuminate yellow.

For the locations of the parallel communication cards, auxiliary power cards, power modules and their LED indicators, please refer to **Figure 6-1**.

- 4) The LCD initial screen (see **Figure 6-39**) will appear within 40 seconds after the Input Switch (Q1) and Bypass Switch (Q2) are turned on.



(Figure 6-39: LCD Initial Screen)

- 5) After 20 seconds of LCD initialization, the LCD will enter the **Main Screen**. For the **Main Screen** information, please refer to **7.6 Main Screen**.

If the bypass AC source is within the normal range, the UPS will transfer to run in Bypass mode, the LCD screen will show as **Figure 6-40** and the tri-color LED indicator will illuminate yellow.

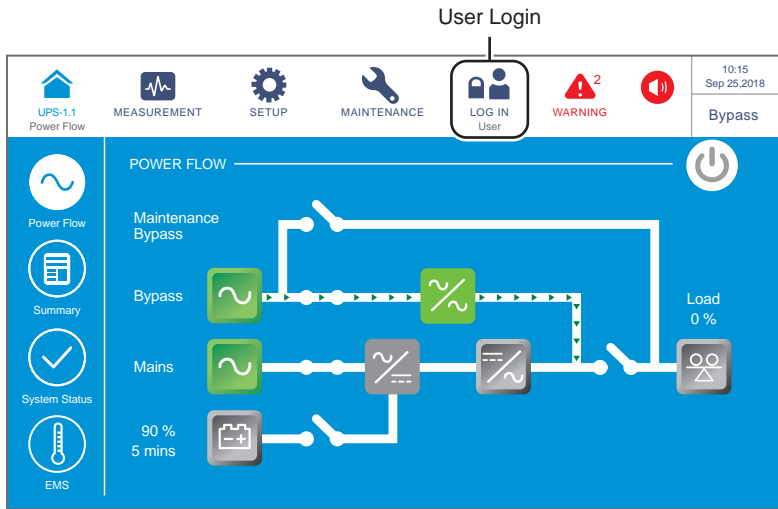

(Figure 6-40: Main Screen_ User Login)

- 6 Please log in as an **Administrator**. For the **Administrator** password, please contact service personnel. After login, ensure that you are in the **Administrator** login status (see **Figure 6-41**).

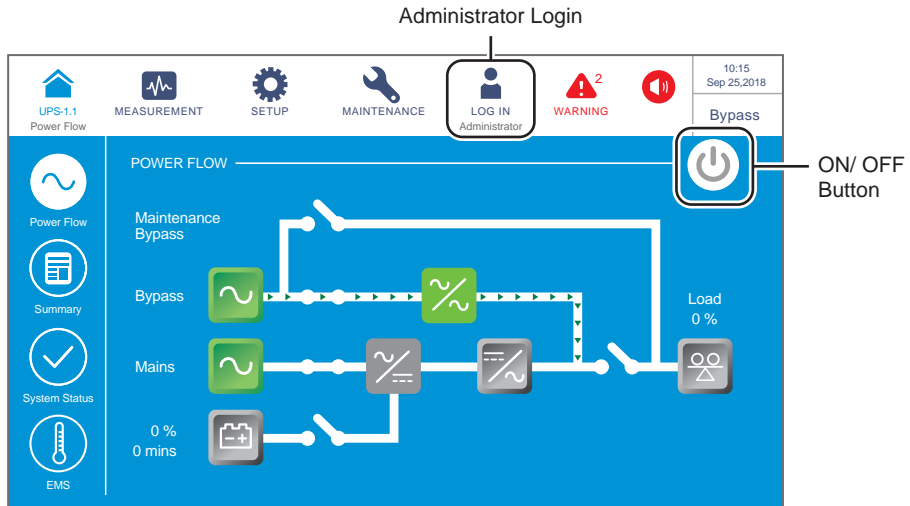

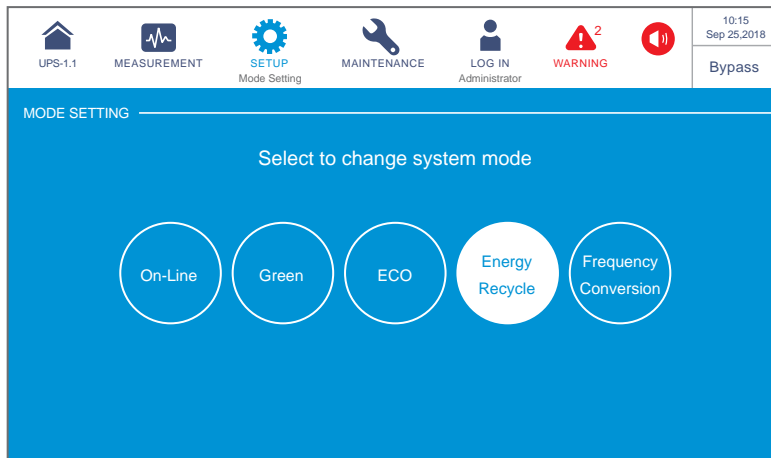

(Figure 6-41: Main Screen_ Administrator Login & ON/ OFF Button Location)

- 7 Go to **SETUP** → **Mode Setting** → **Energy Recycle**.



(Figure 6-42: Select Energy Recycle Mode)

- 8 After manually selecting **Energy Recycle** mode via the LCD, tap the icon () located in the upper left corner of the screen to go back to the **Main Screen**.
- 9 Tap the ON/ OFF Button () and the following screen will pop up to ask if you want to power on the UPS's inverter. Please select '**YES**'.

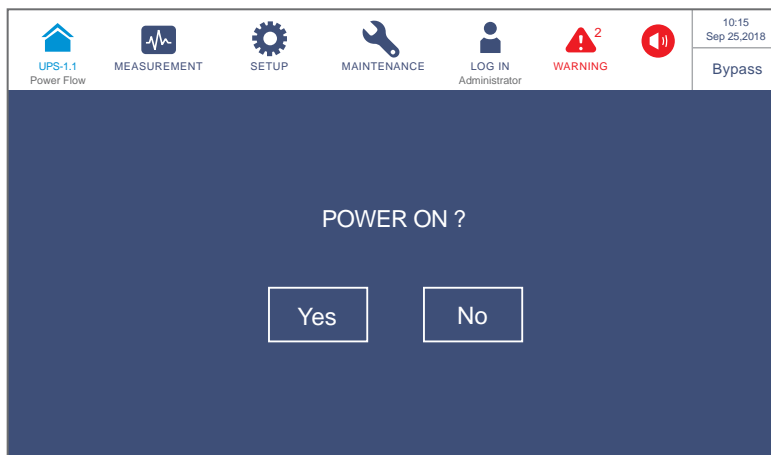

(Figure 6-43: Power on Reminder Screen)

- 10 After selection of '**YES**' to start up the UPS's inverter, each power module will start up and perform self-inspection. At the same time, the system begins synchronization with the bypass AC source. After the self-inspection is completed, the UPS will automatically transfer to run in Energy Recycle mode and perform self-aging test. Now, the tri-color LED indicator illuminates yellow and the following screen appears.

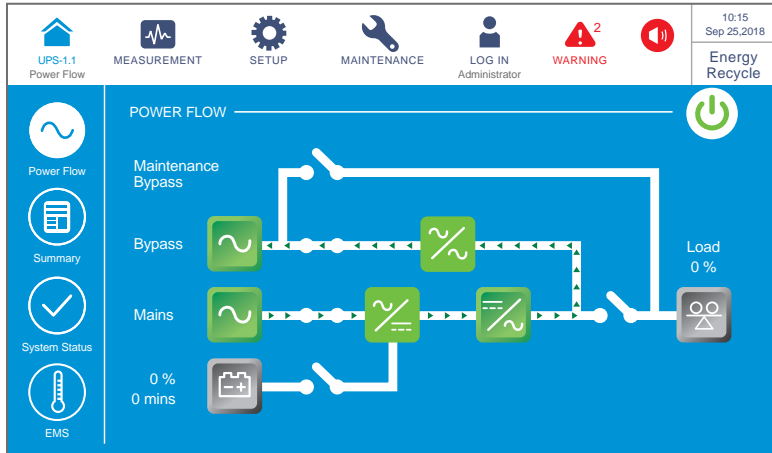

(Figure 6-44: Energy Recycle Mode Screen)

6.3 Turn-off Procedures

6.3.1 On-Line Mode Turn-off Procedures



WARNING:

1. For parallel units, ensure that every operation procedure mentioned below is synchronized to all parallel UPSs.
2. For parallel application, if you just want to operate a specific UPS but not all parallel ones, please contact service personnel.

- ① In On-Line mode, the LCD shows the following screen (**Figure 6-45**) and the tri-color LED indicator illuminates green.

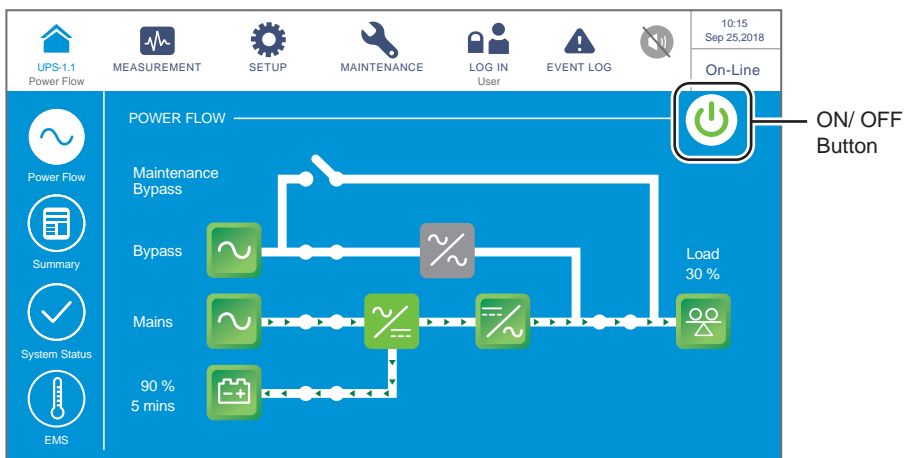

(Figure 6-45: On-Line Mode Screen & ON/ OFF Button Location)

- 2 Tap the ON/ OFF Button () and the following screen will pop up to ask if you want to power off the UPS's inverter. Please select 'YES'.

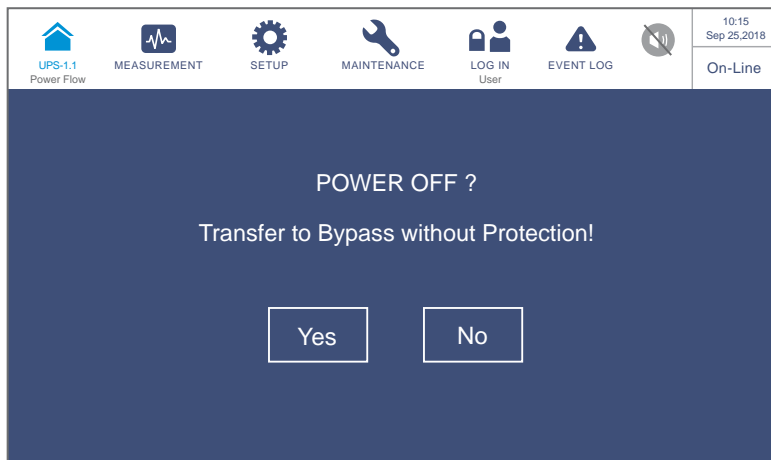

(Figure 6-46: Power off Reminder Screen)

- 3 After selection of 'YES', the UPS will shut down the inverter, terminate each power module's output and let the bypass AC source supply power. If the bypass AC source is abnormal, there is a risk of output interruption and the connected critical loads won't be protected. At this moment, each power module keeps charging the batteries, the tri-color LED indicator illuminates yellow and the following screen (**Figure 6-47**) appears.

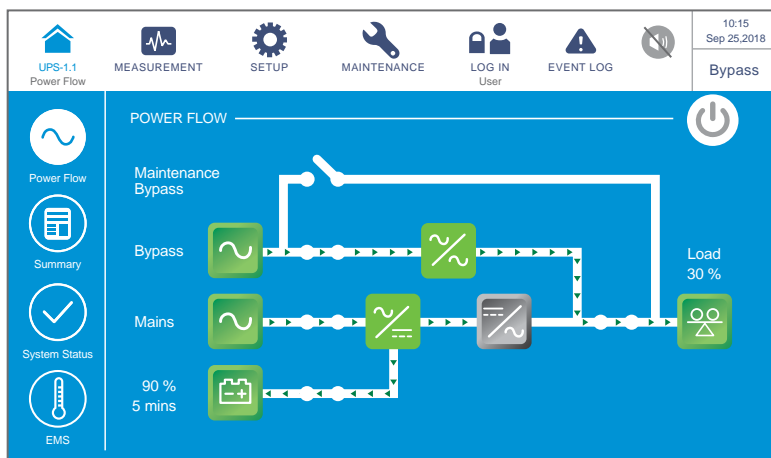

(Figure 6-47: Bypass Mode Screen)

- 4 Switch **OFF** the Input Switch (Q1), Bypass Switch (Q2) and Output Switch (Q4). After that, the UPS will run in Standby mode.
- 5 Now, each power module performs DC BUS discharging and its LED indicator flashes green. After discharging, each power module's LED indicator will be off.
- 6 About 3 minutes later, the UPS will shut down, and the LCD and tri-color LED indicator will be off.
- 7 Switch **OFF** every external battery cabinet's breaker (Q5).

6.3.2 Battery Mode Turn-off Procedures



WARNING:

1. For parallel units, ensure that every operation procedure mentioned below is synchronized to all parallel UPSs.
2. For parallel application, if you just want to operate a specific UPS but not all parallel ones, please contact service personnel.

- 1 In Battery mode, the LCD shows the following screen (**Figure 6-48**) and the tri-color LED indicator illuminates yellow.

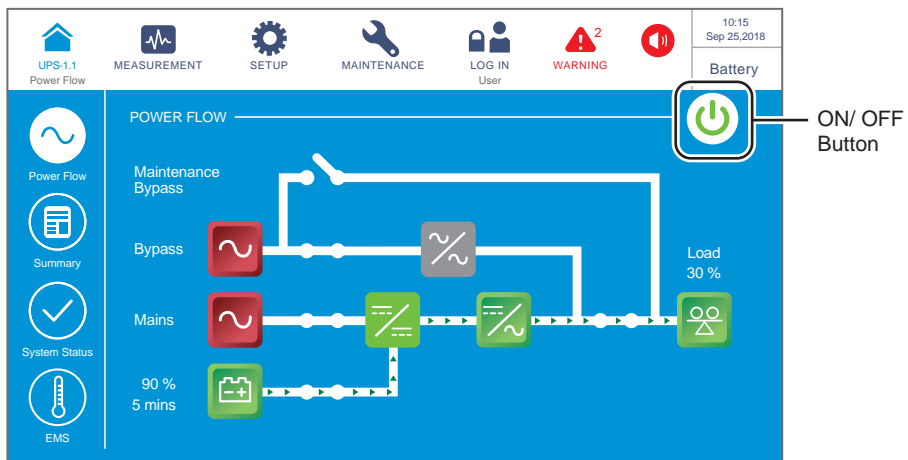

(Figure 6-48: Battery Mode Screen & ON/ OFF Button Location)

- 2 Tap the ON/ OFF Button () and the following screen will pop up to ask if you want to power off the UPS's inverter. Please select 'YES'.



WARNING:

Please note that, once you select 'YES', all power will be completely cut off. Please make sure that the critical loads connected to the UPS have already been safely shut down before you perform the turn-off procedures.

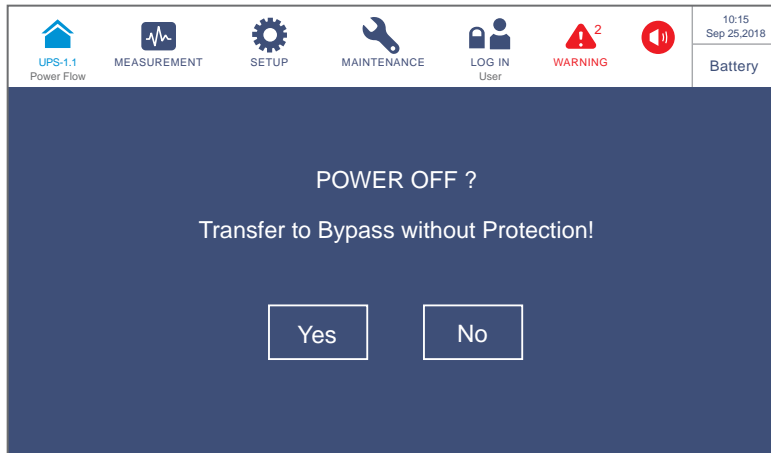

(Figure 6-49: Power off Reminder Screen)

- 3) After selection of 'YES', the UPS will shut down the inverter, terminate each power module's output and transfer to run in Standby mode. At this moment, the tri-color LED indicator illuminates yellow and the following screen (Figure 6-50) appears.

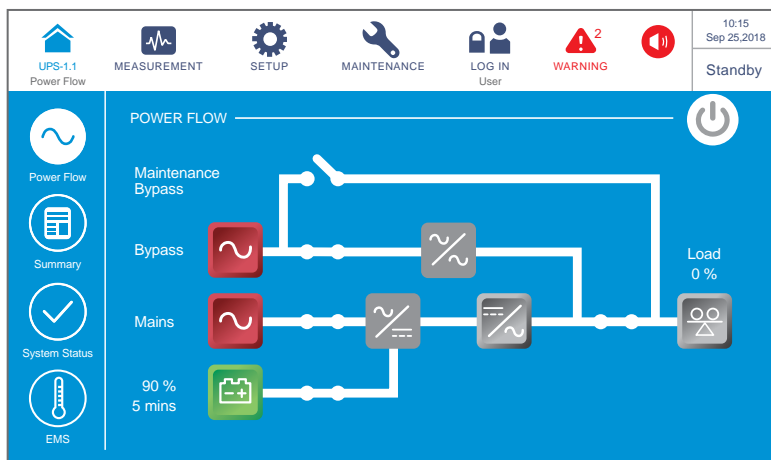

(Figure 6-50: Standby Mode Screen)

- 4) Switch **OFF** the Input Switch (Q1), Bypass Switch (Q2) and Output Switch (Q4).
- 5) Now, each power module performs DC BUS discharging and its LED indicator flashes green. After discharging, each power module's LED indicator will be off.
- 6) About 3 minutes later, the UPS will shut down, and the LCD and tri-color LED indicator will be off.
- 7) Switch **OFF** every external battery cabinet's breaker (Q5).

6.3.3 Bypass Mode Turn-off Procedures



WARNING:

1. For parallel units, ensure that every operation procedure mentioned below is synchronized to all parallel UPSs.
2. For parallel application, if you just want to operate a specific UPS but not all parallel ones, please contact service personnel.

- 1 In Bypass mode, the LCD shows the following screen (**Figure 6-51**) and the tri-color LED indicator illuminates yellow.

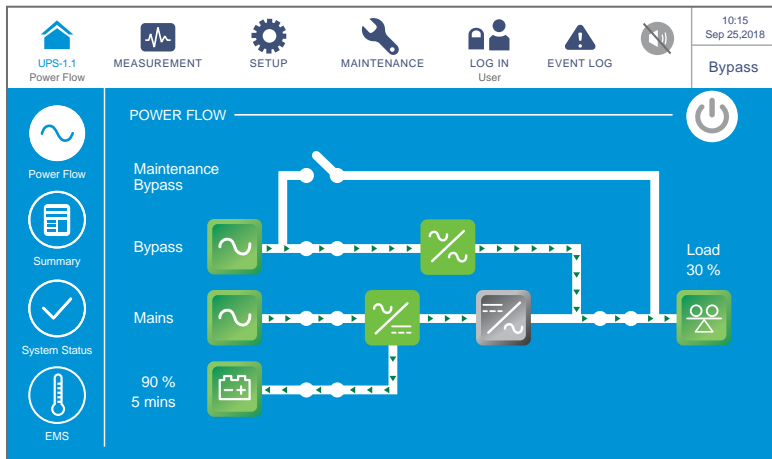

(Figure 6-51: Bypass Mode Screen)

- 2 Switch **OFF** the Input Switch (Q1), Bypass Switch (Q2) and Output Switch (Q4). After that, the UPS will run in Standby mode.
- 3 Now, each power module performs DC BUS discharging and its LED indicator flashes green. After discharging, each power module's LED indicator will be off.
- 4 About 3 minutes later, the UPS will shut down, and the LCD and tri-color LED indicator will be off.
- 5 Switch **OFF** every external battery cabinet's breaker (Q5).

6.3.4 Manual Bypass Mode Turn-off Procedures



WARNING:

1. For parallel units, ensure that every operation procedure mentioned below is synchronized to all parallel UPSs.
2. For parallel application, if you just want to operate a specific UPS but not all parallel ones, please contact service personnel.

In Manual Bypass mode, the LCD and tri-color LED indicator are both **OFF**. To completely shut down the UPS, switch **OFF** the Manual Bypass Switch (Q3).



NOTE:

1. Ensure that the LCD, all LED indicators and fans are **OFF**.
2. Check that all the switches, breakers and power are **OFF**.

6.3.5 ECO Mode Turn-off Procedures



WARNING:

1. For parallel units, ensure that every operation procedure mentioned below is synchronized to all parallel UPSs.
2. For parallel application, if you just want to operate a specific UPS but not all parallel ones, please contact service personnel.

1 In ECO mode, the LCD shows the following screen (**Figure 6-52**) and the tri-color LED indicator illuminates green.

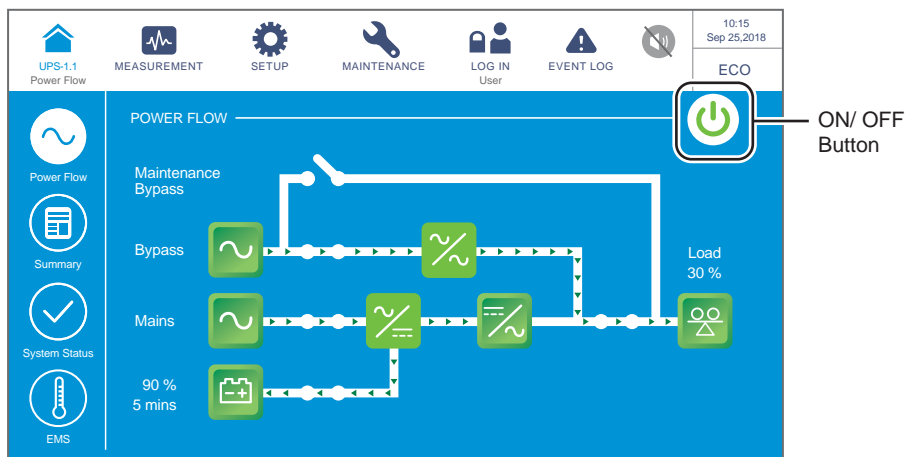

(Figure 6-52: ECO Mode Screen & ON/ OFF Button Location)

- 2 Tap the ON/ OFF Button () and the following screen will pop up to ask if you want to power off the UPS's inverter. Please select 'YES'.

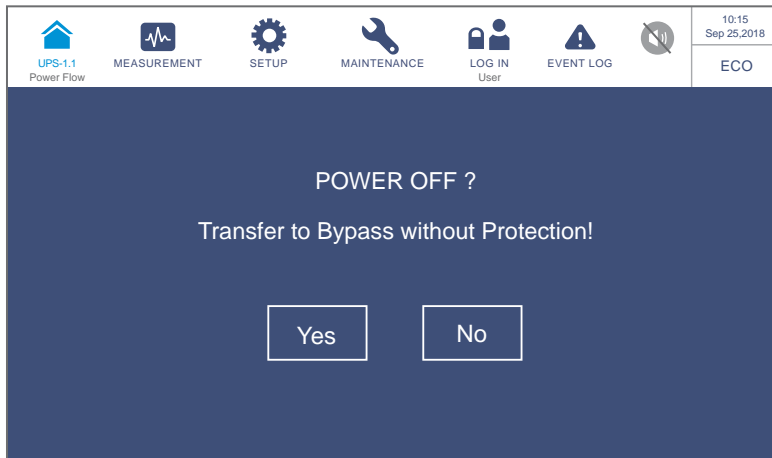

(Figure 6-53: Power off Reminder Screen)

- 3 After selection of 'YES', the UPS will shut down the inverter, terminate each power module's output and let the bypass AC source supply power. If the bypass AC source is abnormal, there is a risk of output interruption and the connected critical loads won't be protected. At this moment, each power module keeps charging the batteries, the tri-color LED indicator illuminates yellow and the following screen appears (Figure 6-54).

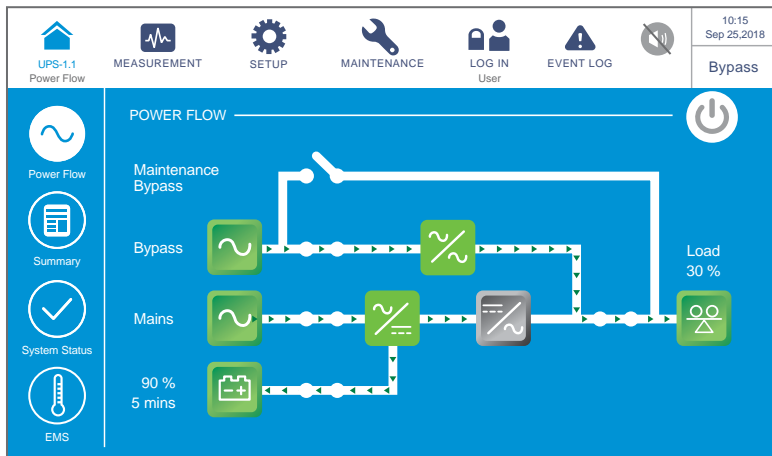

(Figure 6-54: Bypass Mode Screen)

- 4 Please log in as an **Administrator**. For the **Administrator** password, please contact service personnel. After login, ensure that you are in the **Administrator** login status (see **Figure 6-55**).

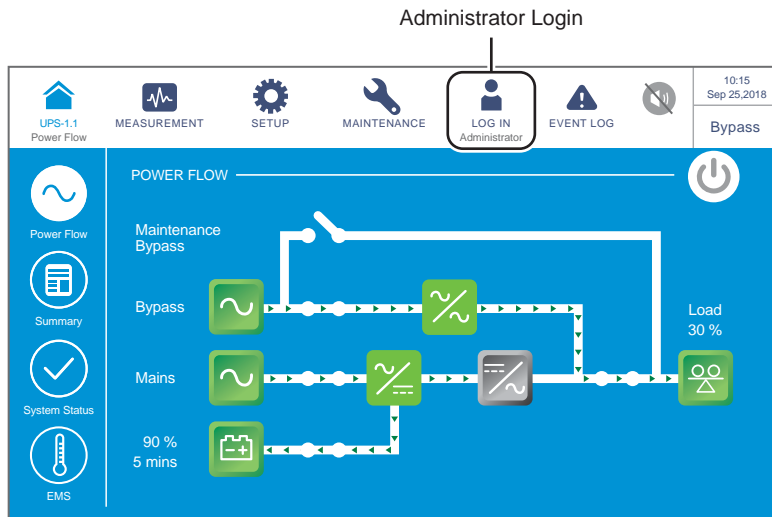

(Figure 6-55: Bypass Mode Screen_ Administrator Login)

- 5 Go to **SETUP** → **Mode Setting** → **On-Line**.

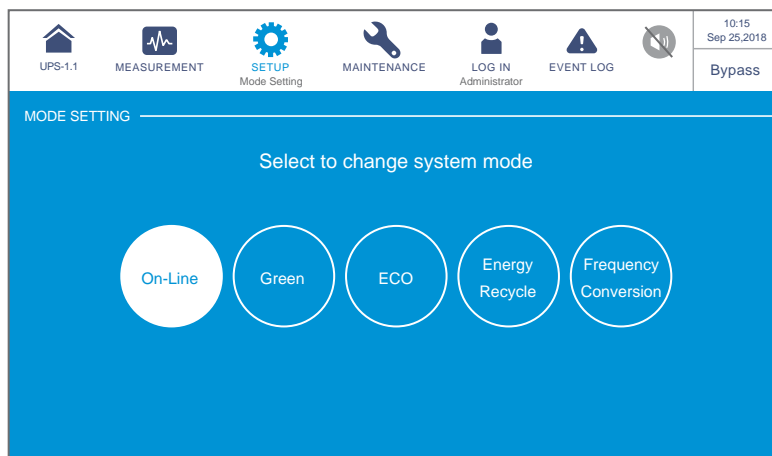

(Figure 6-56: Select Online Mode)

- 6 Switch **OFF** the Input Switch (Q1), Bypass Switch (Q2) and Output Switch (Q4). After that, the UPS will run in Standby mode.
- 7 Now, each power module performs DC BUS discharging and its LED indicator flashes green. After discharging, each power module's LED indicator will be off.

- 8) About 3 minutes later, the UPS will shut down, and the LCD and tri-color LED indicator will be off.
- 9) Switch **OFF** every external battery cabinet's breaker (Q5).

6.3.6 Frequency Conversion Mode Turn-off Procedures



WARNING:

1. Frequency Conversion mode is only applicable to single UPS but not to parallel UPSs.
2. When the UPS runs in Frequency Conversion mode, once the inverter becomes off, there is no bypass power supplying to the loads.

- 1) In Frequency Conversion mode, the LCD shows the following screen (**Figure 6-57**) and the tri-color LED indicator illuminates green.

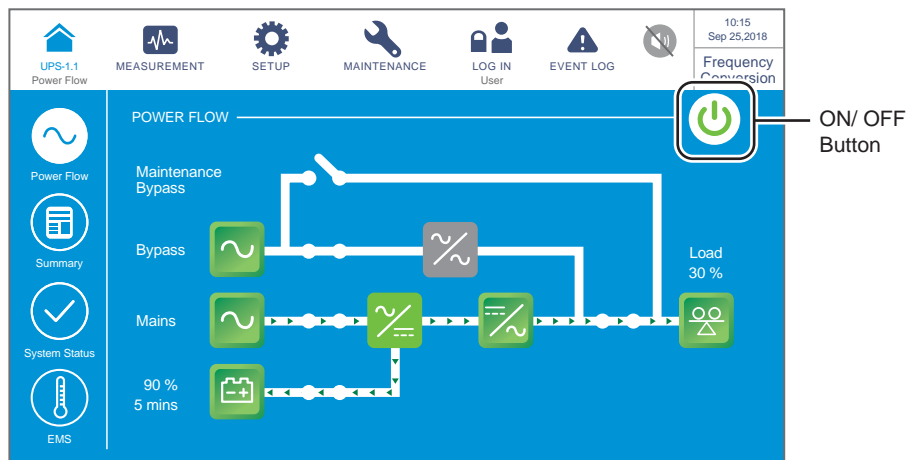

(Figure 6-57: Frequency Conversion Mode Screen & ON/ OFF Button Location)

- 2) Tap the ON/ OFF Button (🔌) and the following screen will pop up to ask if you want to power off the UPS's inverter. Please select 'YES'.



WARNING:

Please note that, once you select 'YES', all power will be completely cut off. Please make sure that the critical loads connected to the UPS have already been safely shut down before you perform the turn-off procedures.

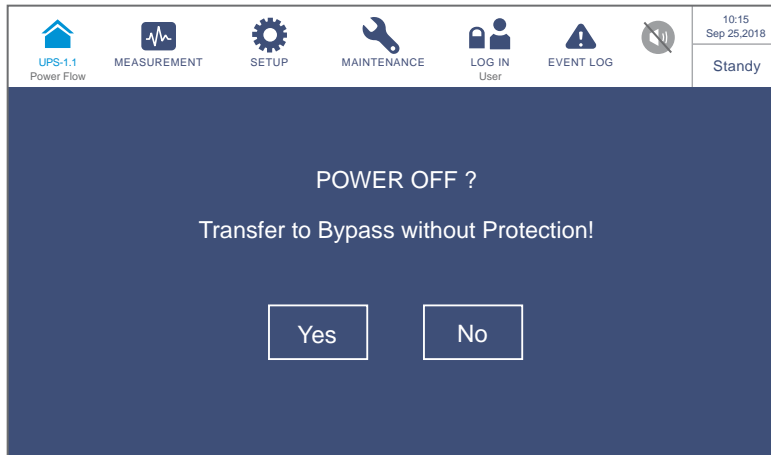

(Figure 6-58: Power off Reminder Screen)

- 3 After selection of **'YES'**, the UPS will shut down the inverter and terminate each power module's output. As there is no bypass output in Frequency Conversion mode, all output will be terminated right after the inverter is shut down. Now, each power module keeps charging the batteries, the tri-color LED indicator illuminates yellow and the following screen appears (Figure 6-59).

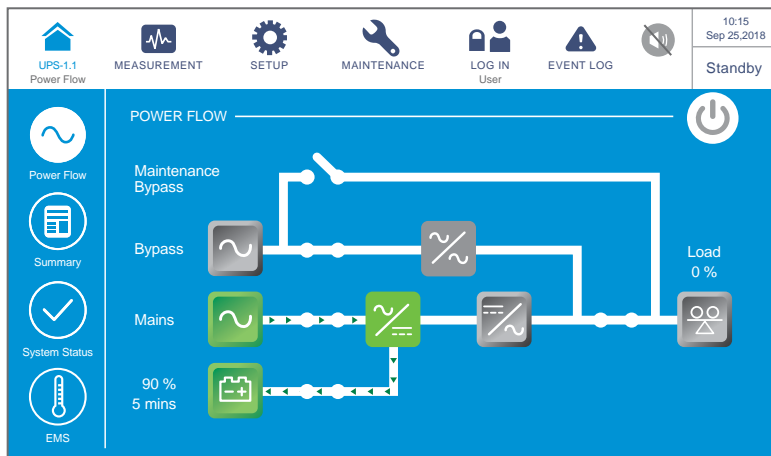

(Figure 6-59: Standby Mode Screen)

- 4 Switch **OFF** the Output Switch (Q4) and log in as an **Administrator**. For the **Administrator** password, please contact service personnel. After login, ensure that you are in the **Administrator** login status (see Figure 6-60).

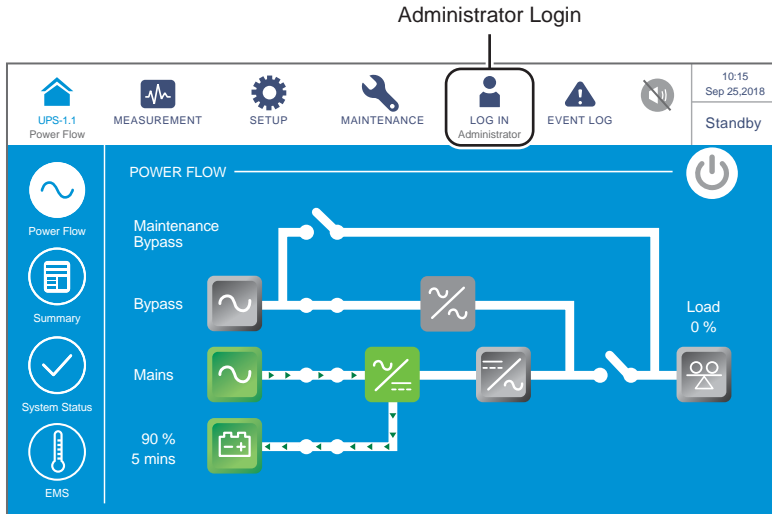

(Figure 6-60: Standby Mode Screen_ Administrator Login)

- 5) Go to **SETUP** → **Mode Setting** → **On-Line**. If the bypass voltage is in the normal range, the UPS will run in Bypass mode to let the bypass AC source supply power to the output.

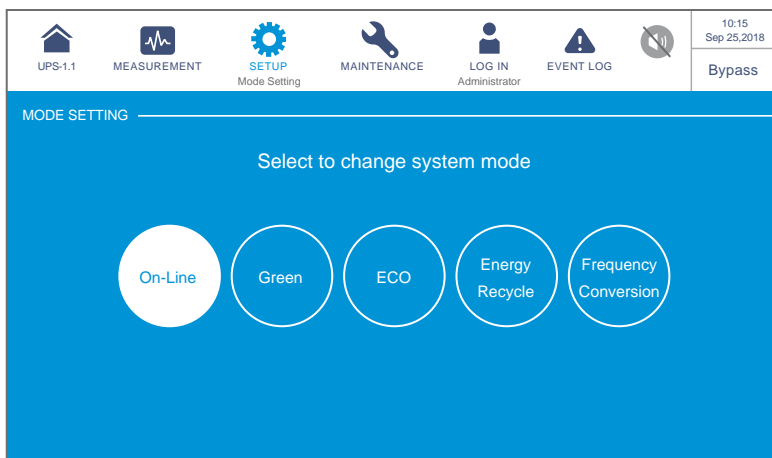

(Figure 6-61: Select Online Mode)

- 6) Switch **OFF** the Input Switch (Q1) and Bypass Switch (Q2).
- 7) Now, each power module performs DC BUS discharging and its LED indicator flashes green. After discharging, each power module's LED indicator will be off.
- 8) About 3 minutes later, the UPS will shut down, and the LCD and tri-color LED indicator will be off.
- 9) Switch **OFF** every external battery cabinet's breaker (Q5).

6.3.7 Green Mode Turn-off Procedures



WARNING:

1. For parallel units, ensure that every operation procedure mentioned below is synchronized to all parallel UPSs.
2. For parallel application, if you just want to operate a specific UPS but not all parallel ones, please contact service personnel.

- 1 In Green mode, the LCD shows the following screen (**Figure 6-62**) and the tri-color LED indicator illuminates green.

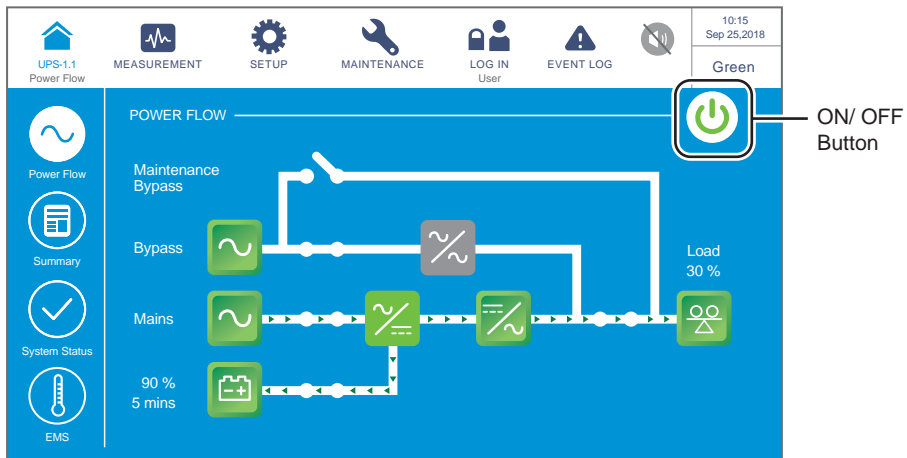

(Figure 6-62: Green Mode Screen & ON/ OFF Button Location)

- 2 Tap the ON/ OFF Button () and the following screen will pop up to ask if you want to power off the UPS's inverter. Please select 'YES'.

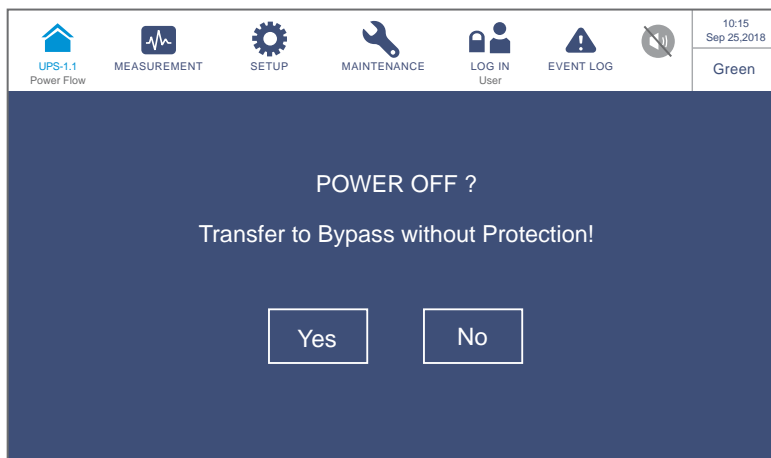

(Figure 6-63: Power off Reminder Screen)

- 3 After selection of 'YES', the UPS will shut down each power module's output and let the bypass AC source supply power. If the bypass AC source is abnormal, there is a risk of output interruption and the connected critical loads won't be protected. At this moment, each power module keeps charging the batteries, the tri-color LED indicator illuminates yellow and the following screen appears (**Figure 6-64**).

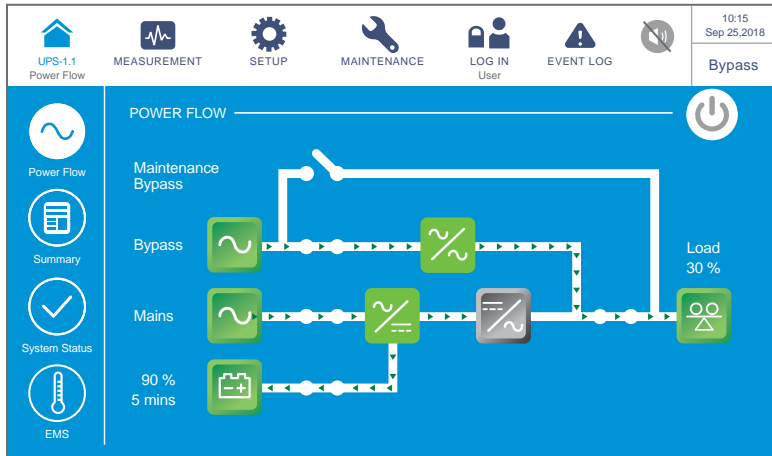

(Figure 6-64: Bypass Mode Screen)

- 4 Please log in as an **Administrator**. For the **Administrator** password, please contact service personnel. After login, ensure that you are in the **Administrator** login status (see **Figure 6-65**).

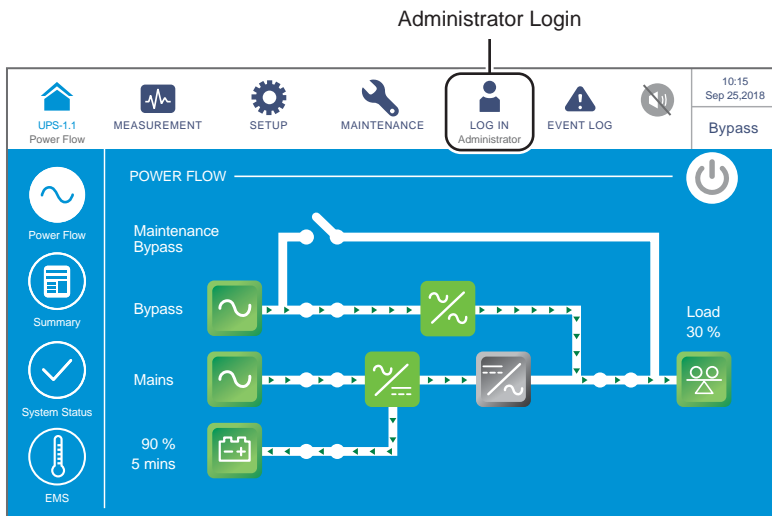

(Figure 6-65: Bypass Mode Screen_ Administrator Login)

- 5 Go to **SETUP** → **Mode Setting** → **On-Line**.

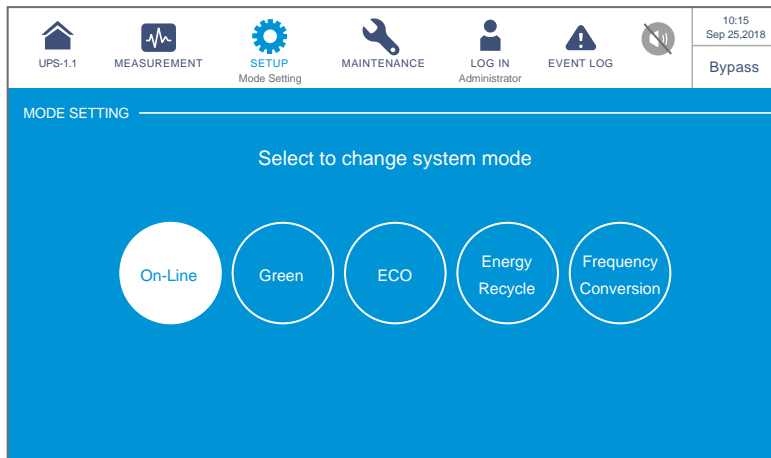

(Figure 6-66: Select On-Line Mode)

- 6 Switch **OFF** the Input Switch (Q1), Bypass Switch (Q2) and Output Switch (Q4). After that, the UPS will run in Standby mode.
- 7 Now, each power module performs DC BUS discharging and its LED indicator flashes green. After discharging, each power module's LED indicator will be off.
- 8 About 3 minutes later, the UPS will shut down, and the LCD and tri-color LED indicator will be off.
- 9 Switch **OFF** every external battery cabinet's breaker (Q5).

6.3.8 Energy Recycle Mode Turn-off Procedures



WARNING:

Energy Recycle mode is only applicable to single input and single unit application.

- 1 In Energy Recycle mode, the LCD shows the following screen (**Figure 6-67**) and the tri-color LED indicator illuminates yellow.

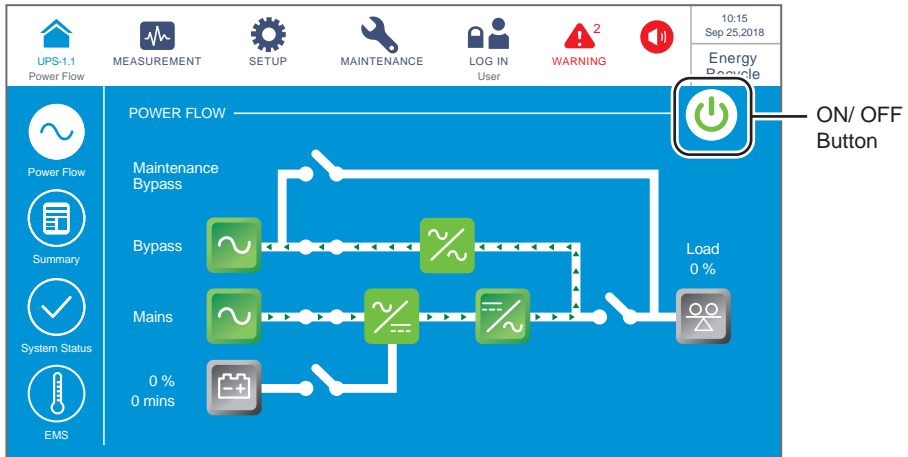

(Figure 6-67: Energy Recycle Mode Screen & ON/ OFF Button Location)

- 2 Tap the ON/ OFF Button (power icon) and the following screen will pop up to ask if you want to power off the UPS's inverter. Please select 'YES'.

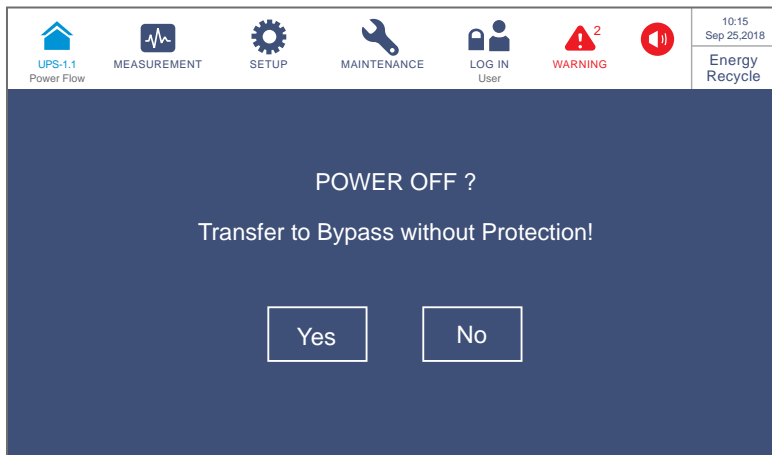

(Figure 6-68: Power off Reminder Screen)

- 3 After selection of 'YES', the UPS will stop self-aging test and transfer to run in Bypass mode. At this moment, the tri-color LED indicator illuminates yellow and the following screen appears (**Figure 6-69**).

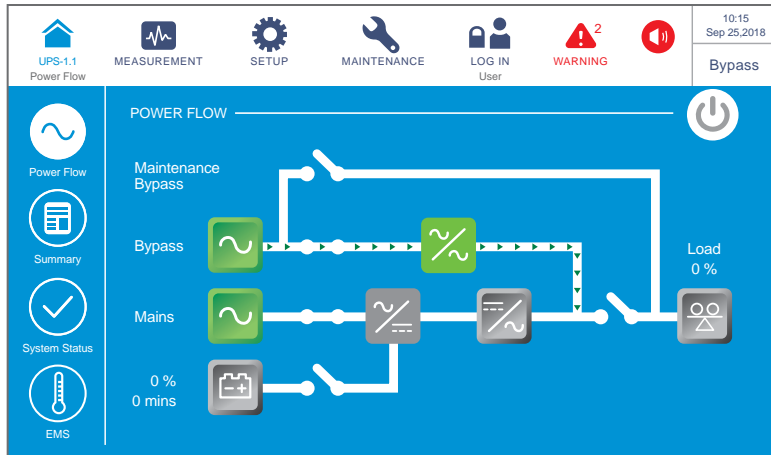

(Figure 6-69: Bypass Mode Screen)

- 4 Please log in as an **Administrator**. For the **Administrator** password, please contact service personnel. After login, ensure that you are in the **Administrator** login status (see **Figure 6-70**).

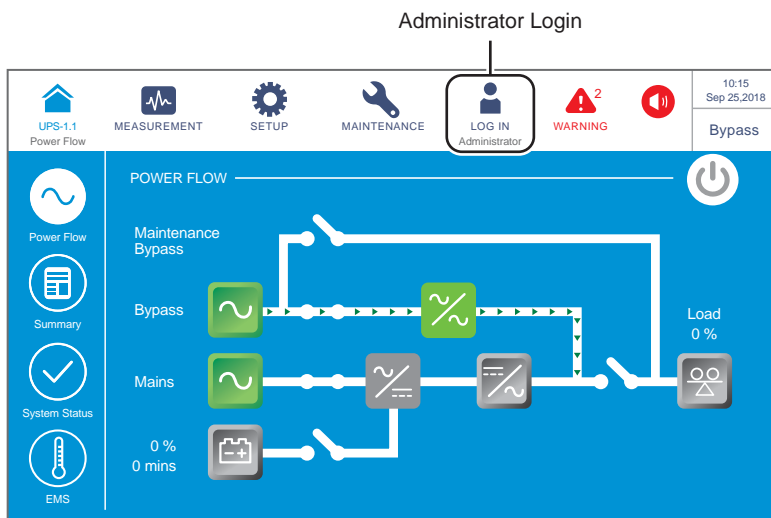

(Figure 6-70: Bypass Mode Screen_ Administrator Login)

5 Go to **SETUP** → **Mode Setting** → **On-Line**.

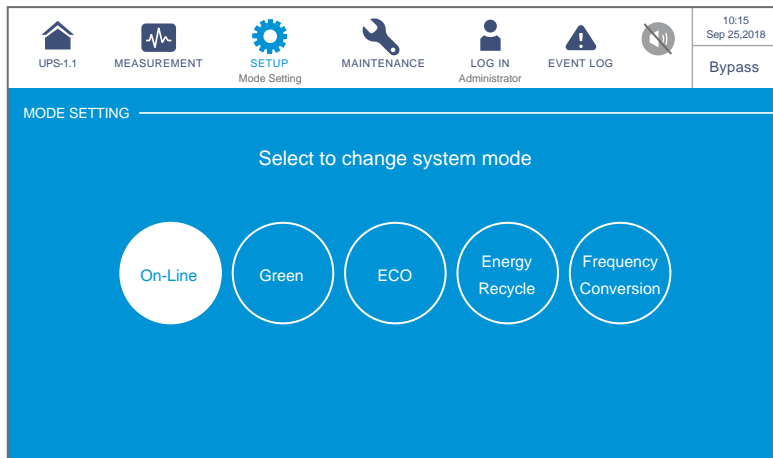

(Figure 6-71: Select Online Mode)

6 Switch **OFF** the Input Switch (Q1) and Bypass Switch (Q2).

7 The UPS will shut down, and then, the LCD and tri-color LED indicator will be off.

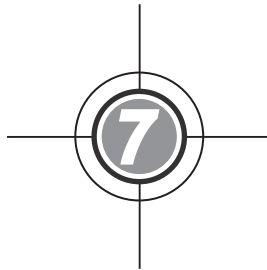

LCD Display & Settings

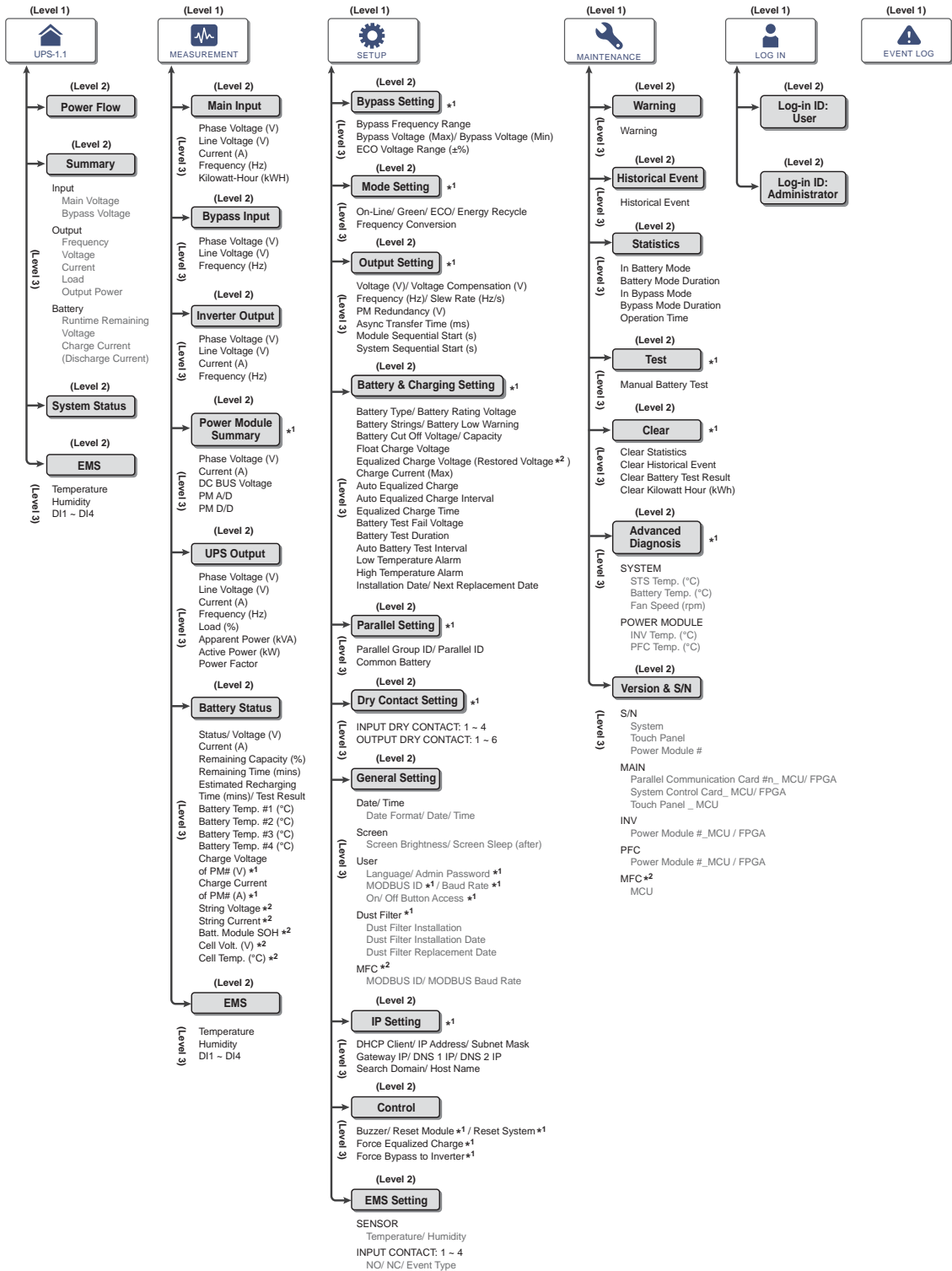

- 7.1 LCD Display Hierarchy
- 7.2 How to Turn on the LCD
- 7.3 ON/ OFF Button
- 7.4 Introduction of Touch Panel and Function Keys
- 7.5 Password Entry
- 7.6 Main Screen
- 7.7 Main Menu
- 7.8 Power Flow, Summary, System Status & EMS
- 7.9 Check System Readings
- 7.10 UPS Settings
- 7.11 System Maintenance

7.1 LCD Display Hierarchy



(Figure 7-1: LCD Display Hierarchy)

**NOTE:**

1. *¹ means that the **Administrator** password is needed. For password information, please refer to **7.5 Password Entry**.
2. *² means that the item will only appear on the LCD if you use the Delta lithium-ion batteries with the optional multifunctional communication card (MFC) being installed in the SMART slot shown in **Figure 4-13**. Please contact Delta customer service if you need more information.
3. The information on the LCD screen presented in **7. LCD Display & Settings**, including the UPS operation mode, machine number, date, time, total number of alarms, load (%), battery remaining time, user login or administrator login, are for reference only. The actual screen of display depends on the operation situation.
4. To turn on the touch panel, please refer to **7.2 How to Turn on the LCD** and **7.3 ON/OFF Button**.
5. (1) The setting of the **On/ Off Button Access** is set as 'Any User' for all the **ON/ OFF Button** () presented in this user manual.
 (2) If you want to change the access setting for the **ON/ OFF Button** (), please go to  → **General Setting** → **User** → **On/ Off Button Access**. For relevant information, please refer to **7.10.7 General Setting**.

7.2 How to Turn on the LCD

To turn on the LCD, please follow the steps below:

- ① Perform one of the options (a. ~ d.) below; after that, the LCD will be on and the LCD initial screen will appear.
 - a. Turn on the Input Switch (Q1); or
 - b. Turn on the Bypass Switch (Q2); or
 - c. Turn on the Input Switch (Q1) and Bypass Switch (Q2); or
 - d. Turn on the external battery cabinet's breaker (Q5), open the two front doors of the UPS, and press any of the battery start buttons (**Figure 7-2**) for 1 second and release it.

(UPS Front View with Door Open)

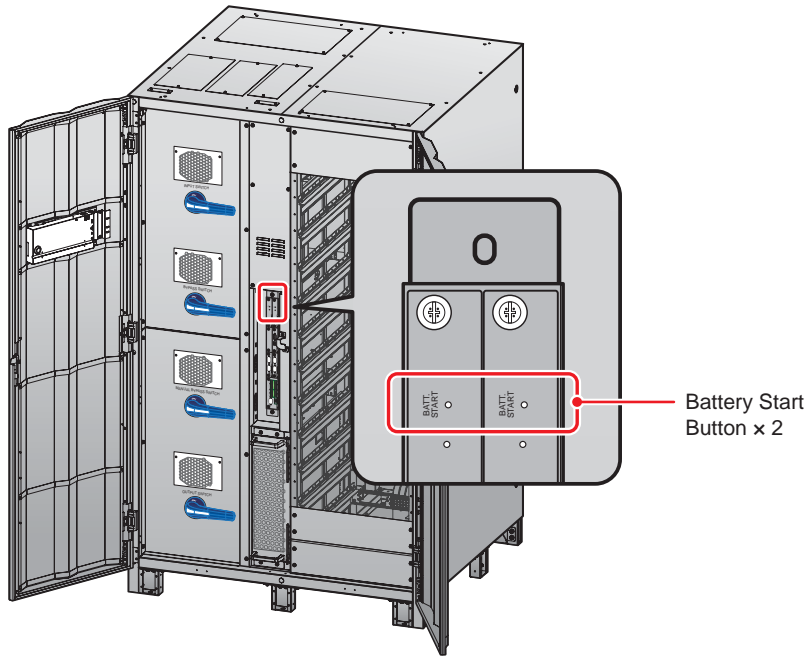

(Figure 7-2: The Position of Battery Start Buttons)



(Figure 7-3: LCD Initial Screen)

- 2 About 20 seconds after the LCD initial screen (see **Figure 7-3**) is on, the **Main Screen** will appear (see **Figure 7-4**). After you see the **Main Screen**, you can operate the LCD. Please note that the **Main Screen** appears in the **User** login status as shown in the figure below.

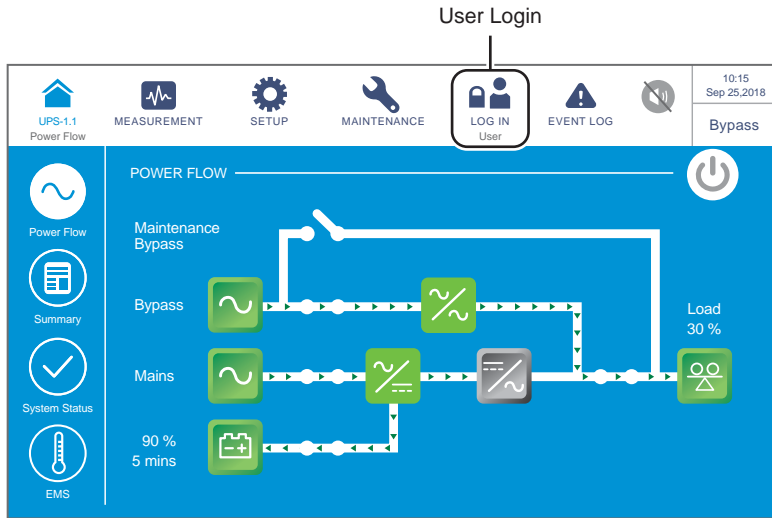

(Figure 7-4: Main Screen_ User Login)

7.3 ON/ OFF Button



NOTE:

1. The setting of the **On/ Off Button Access** is set as 'Any User' for all the **ON/ OFF Button** (⏻) presented in this user manual.
2. If you want to change the access setting for the **ON/ OFF Button** (⏻), please go to  → **General Setting** → **User** → **On/ Off Button Access**. For relevant information, please refer to **7.10.7 General Setting**.

After the touch panel is turned on in accordance with the steps stated in **7.2 How to Turn on the LCD**, the **Main Screen** will appear in the **User** login status and the **ON/ OFF Button** (⏻) shown in **Figure 7-5** will appear.

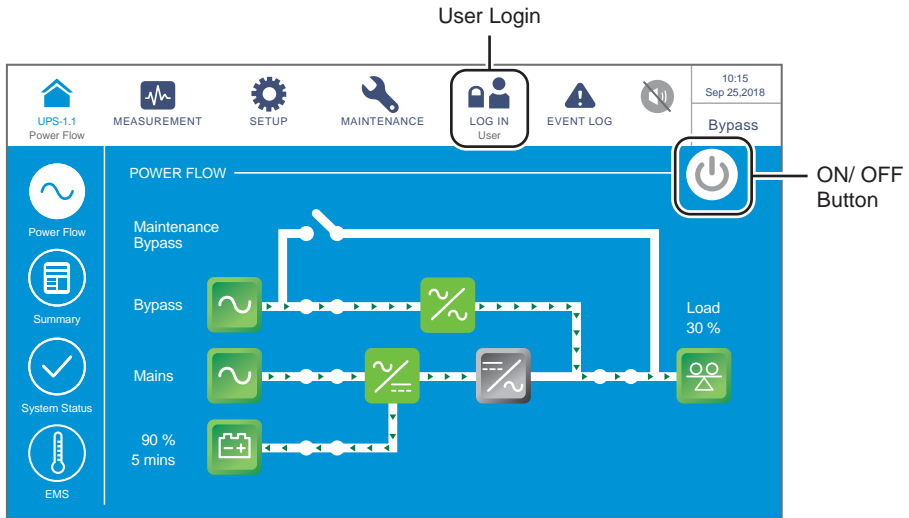

(Figure 7-5: Main Screen_ User Login & ON/ OFF Button Location)

- **Power On**

When the ON/ OFF Button is gray (⏻), it indicates that the UPS's inverter is in the **OFF** status. Tap the button once and a reminder window shown below will pop up to ask for confirmation of '**POWER ON**'.

After selection of '**Yes**', the ON/ OFF Button will turn green (⏻), indicating that the power-on process is completed.

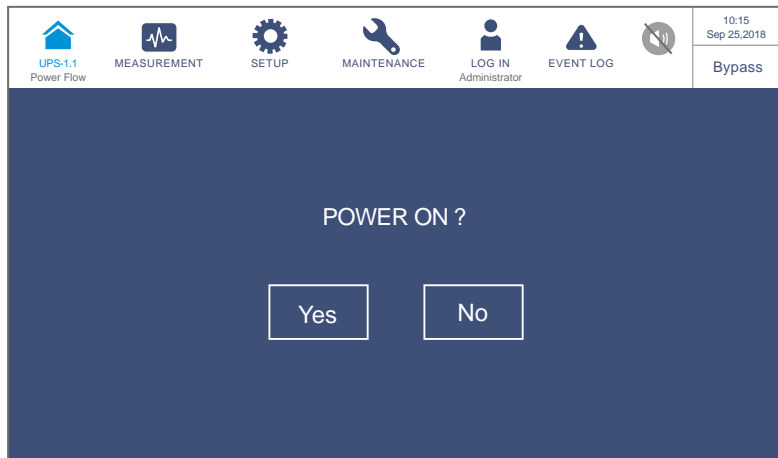

(Figure 7-6: Power on Reminder Window)

• Power Off

When the ON/ OFF Button is green (🔌), it indicates that the UPS's inverter is in the **ON** status. Tap the button once and a reminder window shown below will pop up to ask for confirmation of '**POWER OFF**'.

After selection of '**Yes**', the ON/ OFF Button will turn gray (🔌), indicating that the power-off process is completed.







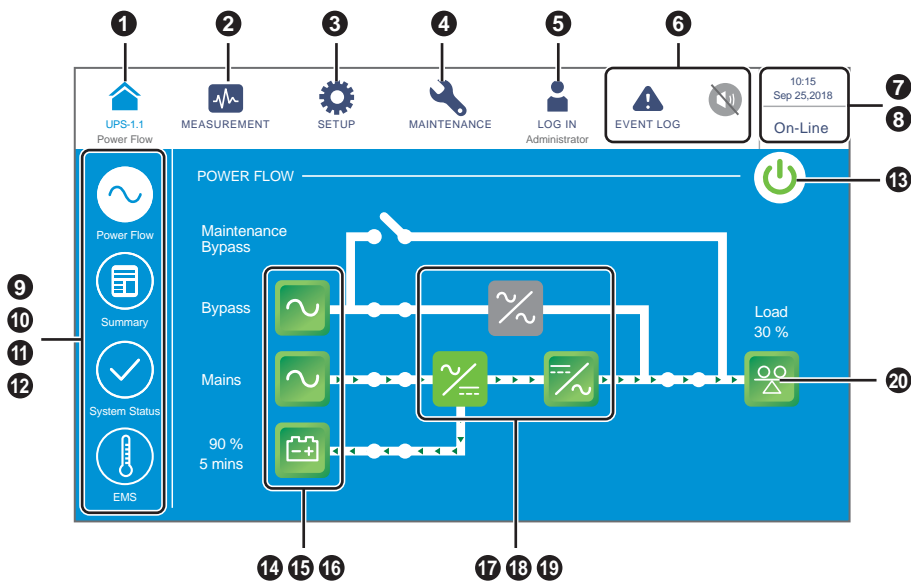

















(Figure 7-7: Power off Reminder Window)







7.4 Introduction of Touch Panel and Function Keys







(Figure 7-8: Introduction of Touch Panel and Function Keys)









No.	Icon/ Text	Button Function (Yes or No)	Text/ Digital Display (Yes or No)	Symbol Display (Yes or No)	Description
1	 UPS-1.1	✓	✓		<p>Tap the button to go back to the Main Screen. The figure (UPS-1.1) below the icon () indicates the parallel group ID no. (former) and the parallel ID no. (latter).</p> <p> NOTE: On the master UPS's screen, you can check its status and readings as well as the slave UPS's partial status and readings. On a slave UPS's screen, you can only check its own status and readings.</p>
2	 MEASUREMENT	✓			Shortcut icon for the measurement menu. For more information, please refer to 7.9 Check System Readings .
3	 SETUP	✓			Shortcut icon for the setup menu. For more information, please refer to 7.10 UPS Settings .
4	 MAINTENANCE	✓			Shortcut icon for the maintenance menu. For more information, please refer to 7.11 System Maintenance .
5	 LOG IN User	✓		✓	Indicates login by User . Tap the icon to change the login permission. For more information, please refer to 7.5 Password Entry .
	 LOG IN Administrator	✓		✓	Indicates login by Administrator . Tap the icon to change the login permission. For more information, please refer to 7.5 Password Entry .











No.	Icon/ Text	Button Function (Yes or No)	Text/ Digital Display (Yes or No)	Symbol Display (Yes or No)	Description
6	 EVENT LOG	✓		✓	<ol style="list-style-type: none"> Event log shortcut icon (). Tap the icon to check all the event logs. When the warning icon () is blue, it indicates that there is no warning.
	 WARNING   WARNING 	✓	✓	✓	<ol style="list-style-type: none"> Warning event shortcut icon (). Buzzer icon (). When the warning icon () is red, it indicates that there is a warning. At this time, the buzzer will sound and the buzzer icon () will appear and light up. The numerical value at the upper right of the red warning icon indicates the total number of warning events. By tapping the buzzer icon (), the buzzer will be muted. At this time, the buzzer disabled icon () will appear. If there is any warning event afterwards, the buzzer will sound and the buzzer icon () will appear and light up again.
7	10:15 Sep 25,2018		✓		Indicates the time and date.
8	On-Line ECO Frequency Conversion Green Energy Recycle Bypass Battery Standby Softstart		✓		Indicates the UPS's current operation status (the actual display depends on the actual operation status).
9	 Power Flow	✓			Shortcut icon for the power flow diagram. Tap the icon to check the operation mode and status of the UPS. For more information, please refer to 7.8 Power Flow, Summary, System Status & EMS .

No.	Icon/ Text	Button Function (Yes or No)	Text/ Digital Display (Yes or No)	Symbol Display (Yes or No)	Description
10		✓			Shortcut icon for summary information. Tap the icon to check the input, output, and battery status of the UPS. For more information, please refer to 7.8 Power Flow, Summary, System Status & EMS .
11		✓			Shortcut icon for system status. Tap the icon to check the status of each power module, parallel communication card, system control card, and auxiliary power card. For more information, please refer to 7.8 Power Flow, Summary, System Status & EMS .
12		✓			Shortcut icon for EMS information. On the EMS screen, you can check the integrated status of each optional EMS 1000 (EnviroProbe) device connected to the UPS (Green: Normal; Yellow: Warning; Red: Alarm; Gray: Off); the integrated status is determined by the most severe status among the device's temperature (°C) status, humidity (%) status, and the status of input contacts DI1 ~ DI4. Please refer to 7.8 Power Flow, Summary, System Status & EMS .
13		✓		✓	ON/ OFF Button. For more information, please refer to 7.3 ON/ OFF Button .
14		✓		✓	1. Bypass input status (Green: Normal; Red: Abnormal or OFF). 2. Bypass input screen shortcut icon.
15		✓		✓	1. Main input status (Green: Normal; Red: Abnormal or OFF). 2. Main input screen shortcut icon.

No.	Icon/ Text	Button Function (Yes or No)	Text/ Digital Display (Yes or No)	Symbol Display (Yes or No)	Description
16		✓	✓	✓	<ol style="list-style-type: none"> Battery status (Green: Normal; Flashing Green & Gray: Battery Mode; Flashing Red & Gray: Battery Not Connected). Battery remaining capacity (%). Battery remaining time (minutes). Battery status screen shortcut icon.
17				✓	Bypass static switch status (Green: ON ; Gray: Abnormal or OFF).
18				✓	Rectifier status (Green: Normal; Gray: Waiting or OFF).
19		✓		✓	<ol style="list-style-type: none"> Inverter status (Green: Normal; Gray: Waiting or OFF). Inverter output screen shortcut icon.
20		✓	✓	✓	<ol style="list-style-type: none"> Output status (Green: Normal; Gray: No Output). Load capacity (%). UPS output screen shortcut icon.

Other icons on the touch panel are shown in the table below.

No.	Icon	Function
1		Goes to the top page.
		
2		Goes to the last page.
		
3		Moves up.
		
4		Moves down.
		



No.	Icon	Function
5		Goes to the previous page.
		
6		Goes to the next page.
		
7		Increases number.
8		Decreases number.
9		1. Indicates the page No. 2. Choose to go to a specific page No.
10		Deletes number(s) / word(s).
		
11		Capital
12		Space



NOTE:

1. After the back light is turned off, you can tap the LCD to return to the **Main Screen**. For information about the **Main Screen**, please refer to **7.6 Main Screen**.
2. The sleep time for the back light can be adjusted. Please refer to **7.10.7 General Setting**.
3. If you are logged in as an **Administrator** (the **Administrator** password is required; please refer to **7.5 Password Entry**), you will be logged out when the backlight is off. Tap to wake up the LCD screen, and it will go back to the **Main Screen** in the **User** login status. Even if you set up the backlight in '**Never Sleep**' mode, you will still be logged out after the screen is idle for 5 minutes.
4. The default language is English. To change the displayed language of the screen, please go to  → **General Setting** → **User** → **Language**. The default language will be different according to different countries.

7.5 Password Entry

1. Password entry is only required for login as an **Administrator**. **User** login does not require a password.
2. Tap  → enter the **Administrator** password (please contact service personnel for the default password) → the icon  appears, indicating the **Administrator** login is successful.
3. To change the **Administrator** password, please go to  → **General Setting** → **User** → **Administrator Password** (4 digits).



NOTE:

Different login IDs (Administrator/ User) have different access to different screens, inspection items and setup items. Please refer to **7.1 LCD Display Hierarchy**.

7.6 Main Screen

1. Please refer to **7.2 How to Turn on the LCD** and **7.3 ON/ OFF Button** to enter the **Main Screen**.
2. The system shows different power flow screens depending on the status of the UPS. Each power flow screen is a **Main Screen**. See the examples below.

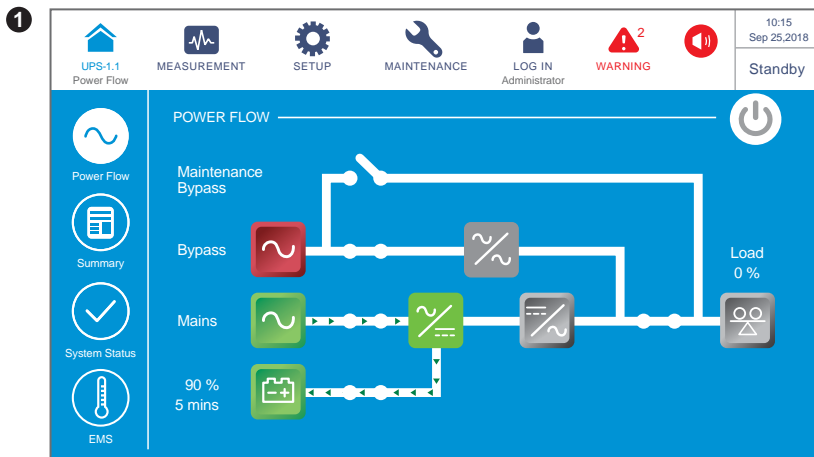

The screen above indicates that the UPS is in **Standby** mode. The inverter is off and the bypass input is out of the range.

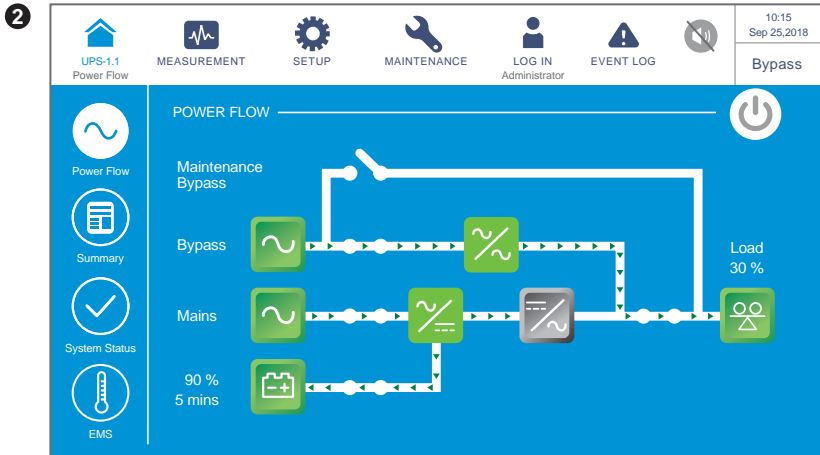

The screen above indicates that the UPS is in **Bypass** mode and the inverter is off.

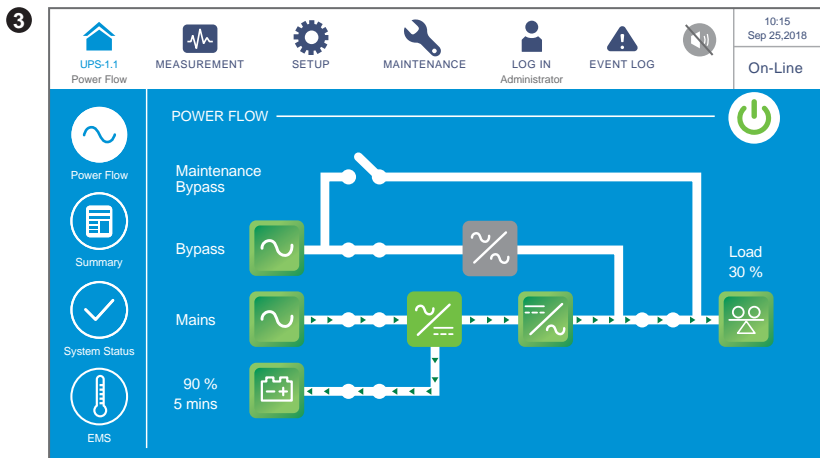

The screen above indicates that the UPS is in **On-Line** mode, and power supply of the loads comes from the inverter. Please refer to **7.10.2 Mode Setting** and **6.2.1 Online Mode Start-up Procedures**.

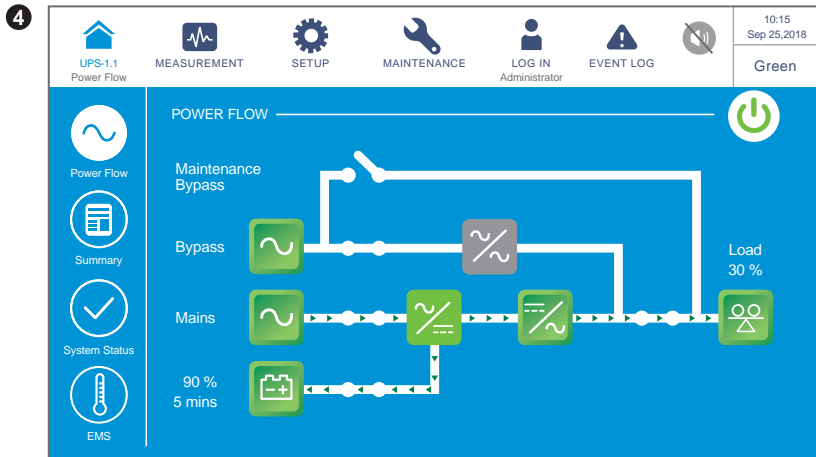

The screen above indicates that the UPS is in **Green** mode, and power supply of the loads comes from the inverter. Power modules will take turn to rest depending on the total load situation. For **Green** mode settings, please refer to **7.10.2 Mode Setting** and **6.2.7 Green Mode Start-up Procedures**.

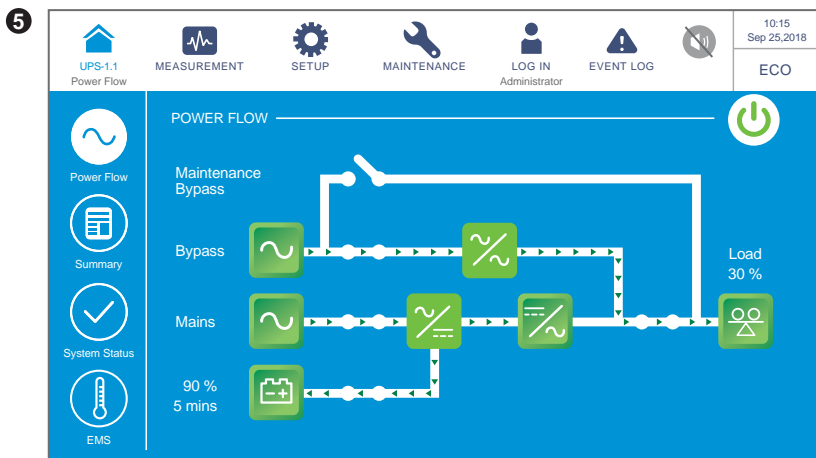

The screen above indicates that the UPS is in **ECO** mode. The inverter is in the ready-to-power-on status, and the power supply of the loads comes from the bypass. For **ECO** mode settings, please refer to **7.10.2 Mode Setting** and **6.2.5 ECO Mode Start-up Procedures**.

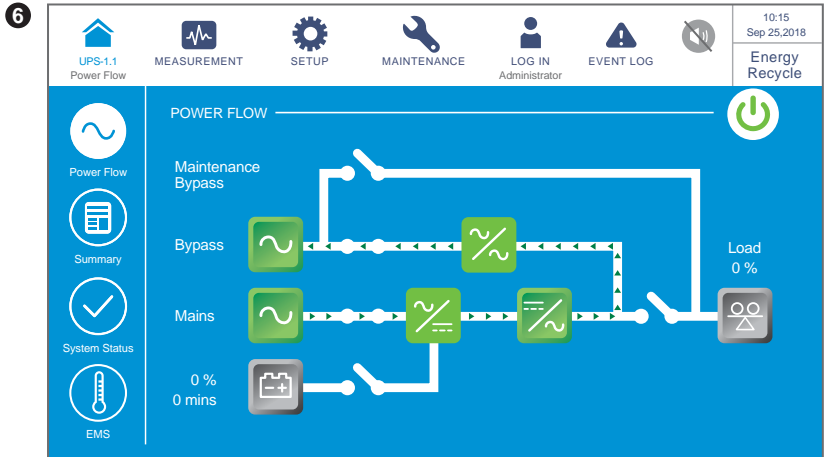

The screen above indicates that the UPS is in **Energy Recycle** mode. The output power will be recycled to the main input without being sent to the loads and the aging test could be conducted. For **Energy Recycle** mode settings, please refer to **7.10.2 Mode Setting** and **6.2.8 Energy Recycle Mode Start-up Procedures**.

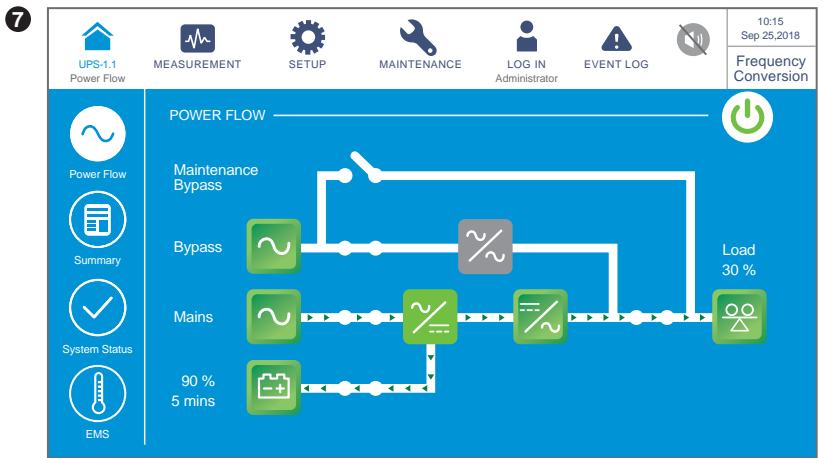

The screen above indicates that the UPS is in **Frequency Conversion** mode and the bypass output is restricted. For **Frequency Conversion** mode settings, please refer to **7.10.2 Mode Setting** and **6.2.6 Frequency Conversion Mode Start-up Procedures**.

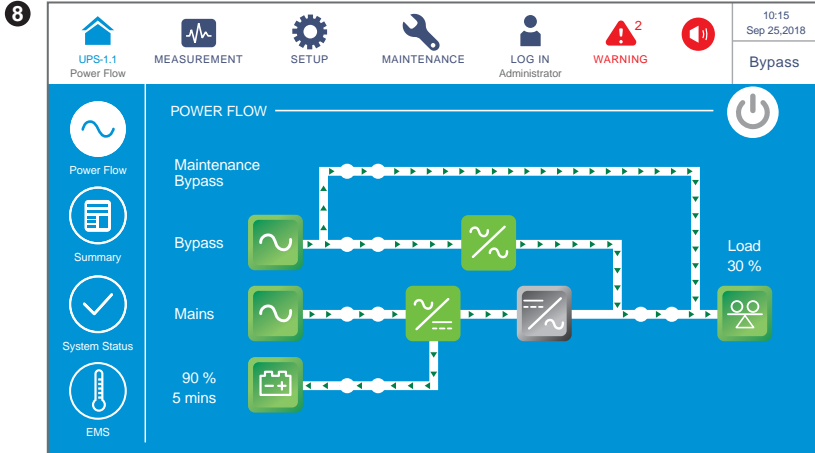



After the Manual Bypass Switch (Q3) is turned on, the UPS will be switched to **Manual Bypass** mode and the screen above will appear. Before maintenance, the UPS must be switched to this mode and you must ensure that the input breaker (Q1), bypass breaker (Q2) and external battery cabinet’s breaker (Q5) are turned **OFF**. After that, the LCD will be off and the loads will not be protected. If there is any sudden malfunction in the bypass AC source, the loads will lose power. Please refer to **6.2.4 Manual Bypass Mode Start-up Procedures**.

7.7 Main Menu

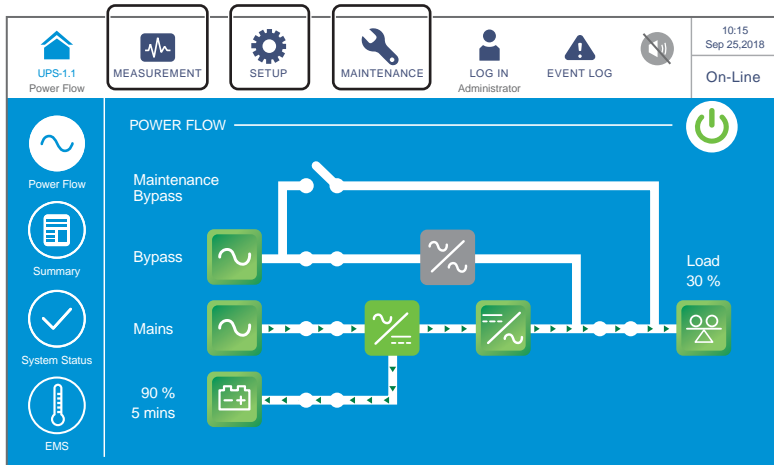
There are three main menu icons  ,  and  , and their positions are shown in the figure below.



Main Menu Icon	Description
 <p>MEASUREMENT</p>	<p>Tap the icon to go to the Measurement Menu. In the menu, you can check the UPS's readings including the following:</p> <ol style="list-style-type: none"> 1. Main Input 2. Bypass Input 3. Inverter Output 4. Power Module Summary 5. UPS Output 6. Battery Status 7. EMS <p>For more information, please refer to 7.9 Check System Readings.</p>
 <p>SETUP</p>	<p>Tap the icon to go to the Setup Menu. In the menu, you can set up the following:</p> <ol style="list-style-type: none"> 1. Bypass Setting 2. Mode Setting 3. Output Setting 4. Battery & Charging Setting 5. Parallel Setting 6. Dry Contact Setting 7. General Setting 8. IP Setting 9. Control 10. EMS Setting <p>For more information, please refer to 7.10 UPS Settings.</p>
 <p>MAINTENANCE</p>	<p>Tap the icon to go to the Maintenance Menu. In the menu, you can (1) check the warning events/ historical events/ statistics/ relevant temperature readings/ firmware versions, (2) execute the manual battery test, (3) clear the statistics/ historical events/ battery test result, and (4) upgrade firmware.</p> <p>In the Maintenance Menu, it includes the following items.</p> <ol style="list-style-type: none"> 1. Warning 2. Historical Event 3. Statistics 4. Test 5. Clear 6. Advanced Diagnosis 7. Version & S/N <p>For more information, please refer to 7.11 System Maintenance.</p>

7.8 Power Flow, Summary, System Status & EMS

There are four shortcut icons for you to check the **Power Flow**, **Summary**, **System Status** and **EMS** respectively. Please see the figure below.

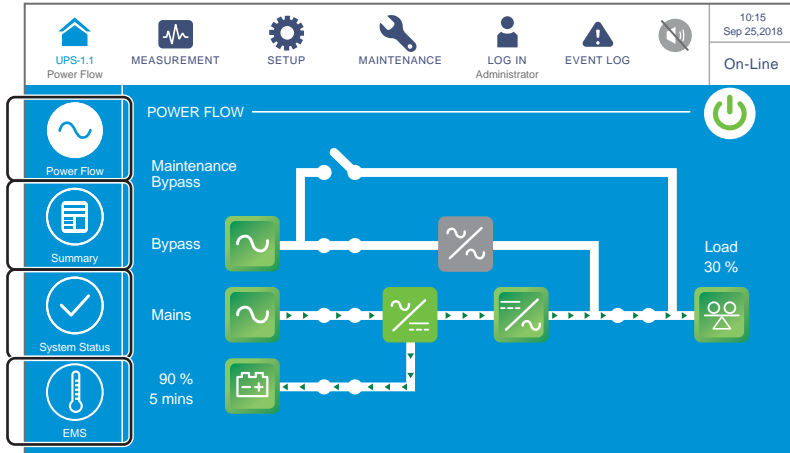

1. Tap the  icon to check the UPS's power flow diagram. Please refer to the figure below.

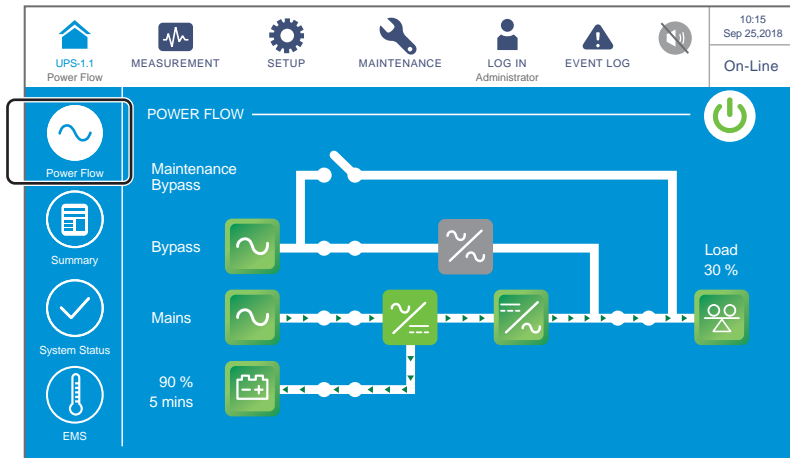

2. Tap the  icon to check information related to input, output and battery. Please refer to the figure below.

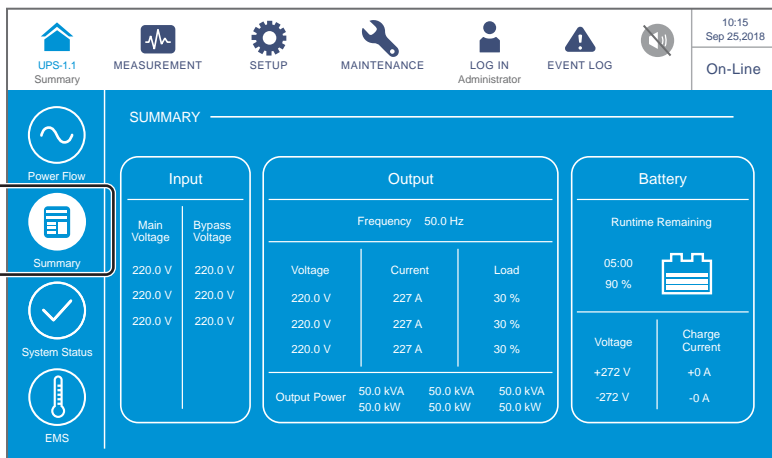

3. Tap the  icon to check the status of the STS module, power modules, parallel communication cards, system control card and auxiliary power cards. Please refer to the figure below.

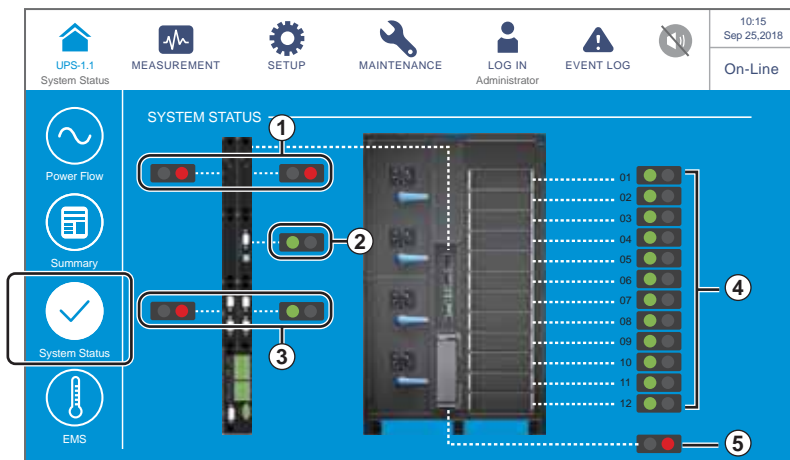

- ① Auxiliary Power Card Status
- ② System Control Card Status
- ③ Parallel Communication Card Status
- ④ Power Module Status
- ⑤ STS Module Status

4. Tap the  icon to check the integrated status of each optional EMS 1000 (EnviroProbe) device connected to the UPS (Green: Normal; Yellow: Warning; Red: Alarm; Gray: Off); the integrated status is determined by the most severe status among the device's temperature (°C) status, humidity (%) status, and the status of input contacts DI1 ~ DI4.

For more EMS information, please refer to **7.9.7 EMS** and **7.10.10 EMS Setting**.

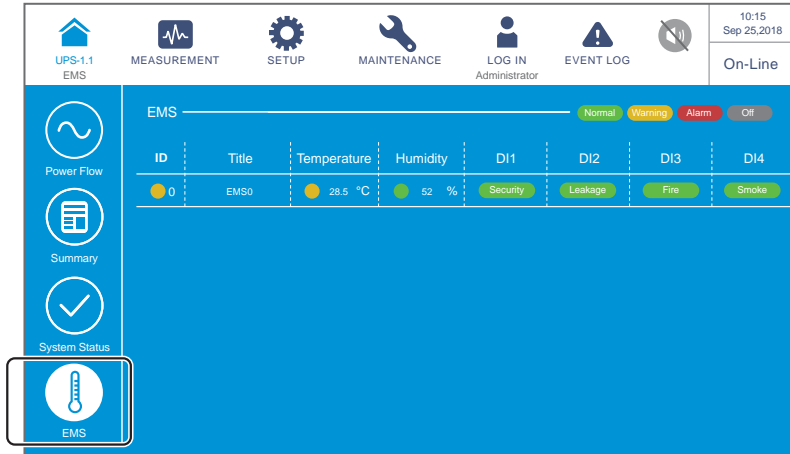

7.9 Check System Readings

7.9.1 Main Input

Path:  → **Main Input**

After entering the **MAIN INPUT** screen (shown in the figure below), you can view the readings of **Phase Voltage**, **Line Voltage**, **Current**, **Frequency** and **Kilowatt-Hour**.

For more information about Kilowatt-Hour, please refer to **7.9.1.1 Check Kilowatt-Hour**.

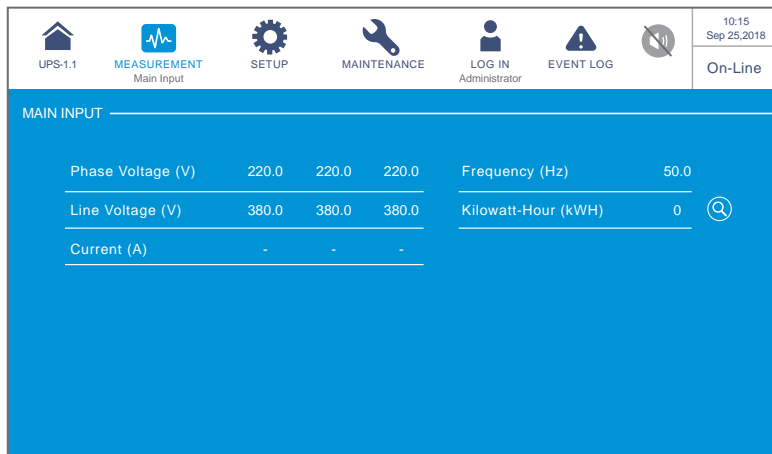

7.9.1.1 Check Kilowatt-Hour

Path:  → Main Input → kWH icon ()

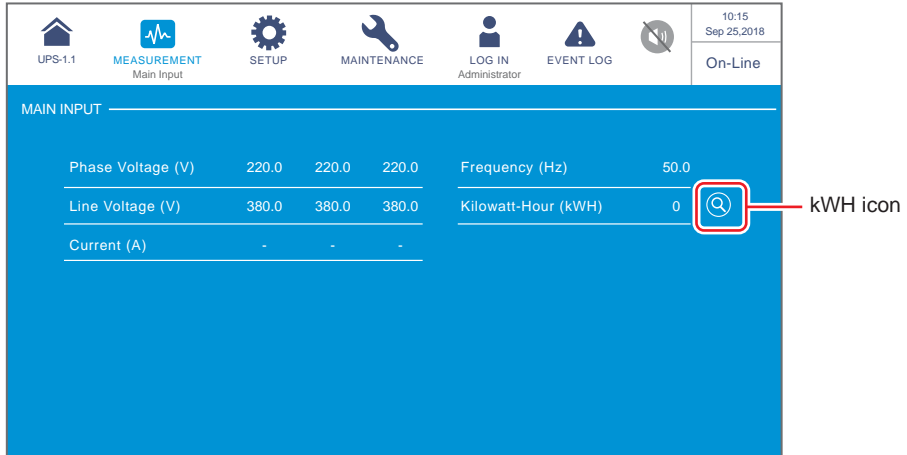

Tap the KWH icon () , and you can check the kWH statistics of the UPS main input in the following window.

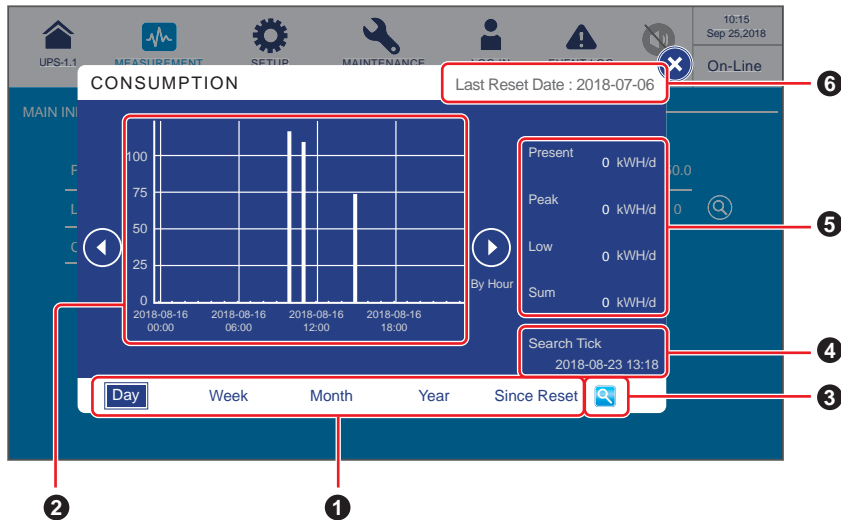

No.	Item	Description
1	Sheet Tabs (Day/ Week/ Month/ Year/ Since Reset)	Tap the sheet tabs to view the kWh statistics and column charts of different time scales.

No.	Item	Description
②	Column Chart	<ol style="list-style-type: none"> Shows the UPS's main input kWh statistics, with time on X-axis and kWh on Y-axis. Tap the column on the chart, and the corresponding piece of data will appear below the chart.
③	Search Tick Setup Icon (🔍)	Tap (🔍), and you can set the date and time for the 'Search Tick' to view the corresponding column chart.
④	Search Tick	Shows the date and time that has been set via (🔍).
⑤	Present/ Peak/ Low/ Sum (kWh/d)	Regardless of different kWh statistics sheets, these four items only indicate today's statistics: the present value/ the highest value (so far)/ the lowest value (so far)/ the sum (so far).
⑥	Last Reset Date	The last date when 'Clear Kilowatt Hour' was executed.

7.9.2 Bypass Input

Path:  → Bypass Input

MEASUREMENT

After entering the **BYPASS INPUT** screen (shown in the figure below), you can view the readings of **Phase Voltage**, **Line Voltage** and **Frequency**.

UPS-1.1	MEASUREMENT Bypass Input	SETUP	MAINTENANCE	LOG IN Administrator	EVENT LOG	10:15 Sep 25, 2018
On-Line						
BYPASS INPUT						
Phase Voltage (V)	220.0	220.0	220.0	Frequency (Hz)	50.0	
Line Voltage (V)	380.0	380.0	380.0			

7.9.3 Inverter Output

Path:  → Inverter Output

After entering the **INVERTER OUTPUT** screen (shown in the figure below), you can view each power module's **Phase Voltage, Line Voltage, Current and Frequency** readings.

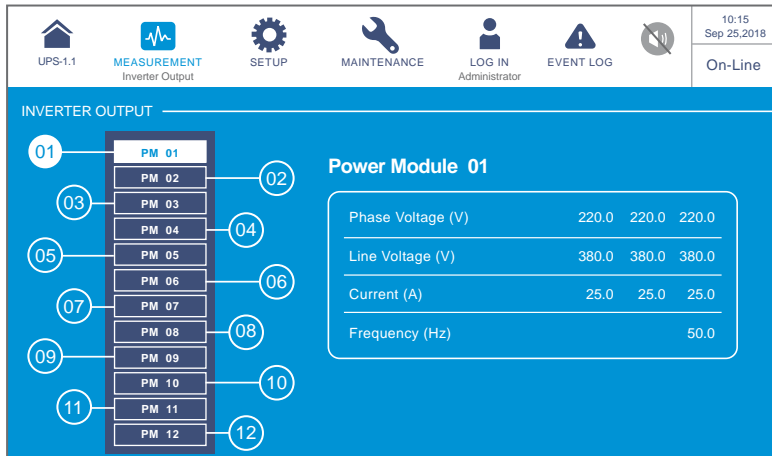

7.9.4 Power Module Summary

Path:  → Power Module Summary

After entering the **POWER MODULE SUMMARY** screen (shown in the figure below), you can view each power module's **Phase Voltage, Current, DC BUS Voltage, PM A/D and PM D/D** readings.

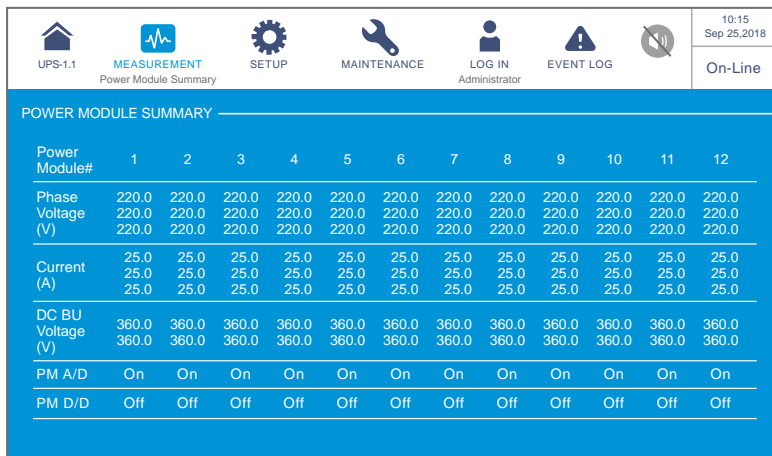







The screenshot shows the 'POWER MODULE SUMMARY' screen. It features a table with 12 columns representing power modules (1-12) and several rows of data. The table is as follows:

Power Module#	1	2	3	4	5	6	7	8	9	10	11	12
Phase Voltage (V)	220.0	220.0	220.0	220.0	220.0	220.0	220.0	220.0	220.0	220.0	220.0	220.0
Current (A)	25.0	25.0	25.0	25.0	25.0	25.0	25.0	25.0	25.0	25.0	25.0	25.0
DC BU Voltage (V)	360.0	360.0	360.0	360.0	360.0	360.0	360.0	360.0	360.0	360.0	360.0	360.0
PM A/D	On	On	On	On	On	On	On	On	On	On	On	On
PM D/D	Off	Off	Off	Off	Off	Off	Off	Off	Off	Off	Off	Off

7.9.5 UPS Output

Path:  → UPS Output







After entering the **UPS OUTPUT** screen (shown in the figure below), you can view the readings of **Phase Voltage, Line Voltage, Current, Frequency, Load, Apparent Power, Active Power** and **Power Factor**.

 UPS-1.1  MEASUREMENT UPS Output  SETUP  MAINTENANCE  LOG IN Administrator  EVENT LOG 						10:15 Sep 25, 2018	
UPS OUTPUT						On-Line	
Phase Voltage (V)	220.0	220.0	220.0	Apparent Power (kVA)	230.0	154.6	168.2
Line Voltage (V)	380.0	380.0	380.0	Active Power (kW)	6391.7	6444.7	118.4
Current (A)	300.0	300.0	300.0	Power Factor	0.00	0.00	0.70
Frequency (Hz)	50.0						
Load (%)	30%	30%	30%				

7.9.6 Battery Status

Path:  → Battery Status

After entering the **BATTERY STATUS** screen (shown in the figure below), you can view the readings of **Status, Voltage, Current, Remaining Capacity, Remaining Time, Estimated Recharging Time, Test Result, Battery Temperature (#1 ~ #4)**, and each power module's **Charge Voltage** and **Charge Current**.

 UPS-1.1  MEASUREMENT Battery Status  SETUP  MAINTENANCE  LOG IN Administrator  EVENT LOG 						10:15 Sep 25, 2018	
BATTERY STATUS						On-Line	
				PAGE 1		PAGE 2	
Status	None			Test Result	None		
Voltage (V)	+ 272.0 - 272.0			Battery Temp. #1 (°C)	-		
Current (A)	+ 0 - 0			Battery Temp. #2 (°C)	-		
Remaining Capacity (%)	90			Battery Temp. #3 (°C)	-		
Remaining Time (mins)	05:00			Battery Temp. #4 (°C)	-		
Estimated Recharging Time (mins)	00:00						

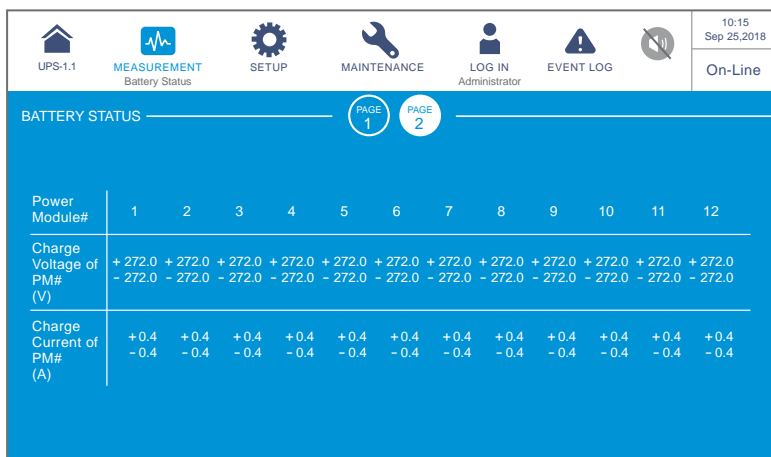

NOTE:

The screen () shown in the following figure will only appear on the LCD if you use the Delta lithium-ion batteries with the optional multifunctional communication card (MFC) being installed in the SMART slot shown in **Figure 4-13**. Please contact Delta customer service if you need more information.

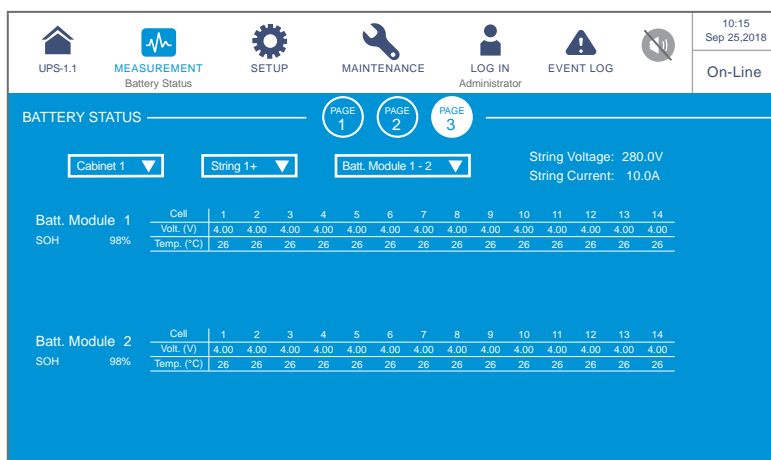

After entering the screen shown above, you can use the three drop-down lists in the upper left corner to choose the **Cabinet**, **String**, and **Battery Module** to view the corresponding **String Voltage**, **String Current**, battery module's **SOH** (State of Health) and battery cell's **Voltage** and **Temperature**.

7.9.7 EMS

Path 1: Tap the shortcut icon () on the **Main Screen**.

Path 2:  → **EMS**

To activate the EMS function of the UPS, you have to connect the optional EMS 1000 (EnviroProbe) device(s) with the UPS; the EMS information of each device (ID #) will be displayed on the **EMS** screen as shown in the figure below. Please refer to the table below for the descriptions of each item shown on the **EMS** screen.



NOTE:

1. The items shown on the **EMS** screen is related to the settings in the () → **EMS Setting**; the settings can be adjusted according to your needs.
2. For installation of the optional EMS 1000 (EnviroProbe), please refer to **7.9.7.1 Connecting the optional EMS 1000 (EnviroProbe)** and the **EnviroProbe 1000 Quick Guide** attached in the package of the optional EMS 1000 (EnviroProbe).

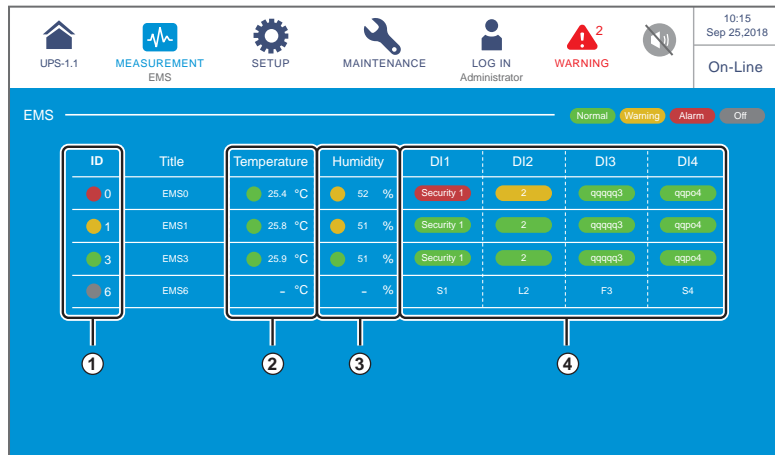

No.	Item	Color (Status)	Descriptions
①	ID	Green (Normal) Yellow (Warning) Red (Alarm) Gray (Off)	<ol style="list-style-type: none"> 1. ID # represents each EMS 1000 (EnviroProbe) device which is connected and set as 'Enable'. 2. Shows the integrated status of each EMS 1000 (EnviroProbe) device. The integrated status is determined by the most severe status among Temperature (°C), Humidity (%) and DI1 ~ DI4.

No.	Item	Color (Status)	Descriptions
②	Temperature	Green (Normal) Yellow (Warning) Red (Alarm)	Shows the statuses of Temperature/ Humidity based on the EMS settings. <ul style="list-style-type: none"> • Green (Normal): lower than the set Warning value. • Yellow (Warning): higher than the set Warning value, but lower than the set Alarm value. • Red (Alarm): higher than the set Alarm value.
③	Humidity	Green (Normal) Yellow (Warning) Red (Alarm)	If Red (Alarm)/ Yellow (Warning) is triggered, the status will recover only when the detected value is lower than the Recovery value.
④	DI1	Green (None/ Information) Yellow (Warning) Red (Alarm)	1. Shows the statuses of the input contacts. 2. The Title , NO/ NC , and Event Type can be adjusted according to your needs.
	DI2		
	DI3		
	DI4		

1. If the status of the EMS 1000 (EnviroProbe) device (ID #) is OFF (gray) as shown in the figure below, it means the communication of the device (ID #) is abnormal.

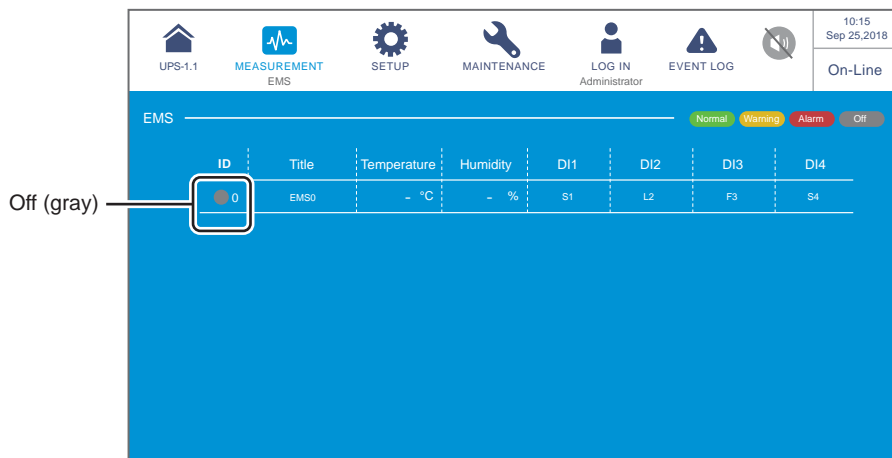

The reasons may be:

- (1) The status of the EMS 1000 (EnviroProbe) device (ID #) has been set as 'Enable' (please refer to **7.10.10 EMS Setting**), but the device (ID #) is not connected to the UPS or the connection cable may be damaged.
- (2) The ID # setting is wrong. Please refer to **7.10.10 EMS Setting**.

At this time, the warning message 'The EMS 1000 ID # Communication Fail' shown in the figure below will appear.

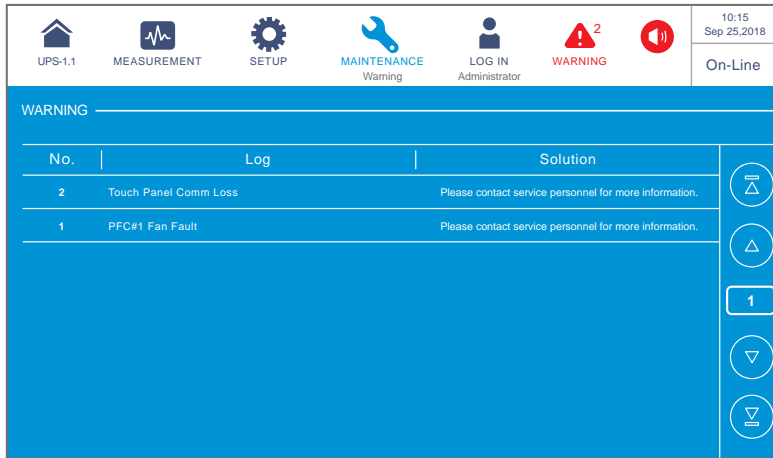

2. After connection of the EMS 1000 (EnviroProbe) to the UPS, if you don't set the status of the EMS 1000 (EnviroProbe) device (ID #) as 'Enable' (please refer to **7.10.10 EMS Setting**), the information of the EMS 1000 (EnviroProbe) device (ID #) will not show on the **EMS** screen.

If none of the status of the EMS 1000 (EnviroProbe) devices (ID #) is set as 'Enable' (please refer to **7.10.10 EMS Setting**), the **EMS** screen will show as follows.

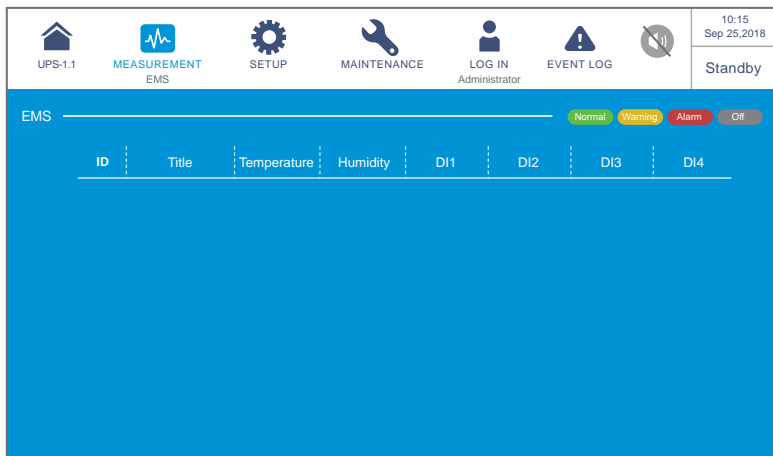

7.9.7.1 Connecting the optional EMS 1000 (EnviroProbe)

1. You can connect a maximum of 16 optional EMS 1000 (EnviroProbe) devices to each UPS to expand the environment monitoring range. A maximum of 8 UPS units can be paralleled. Please use the CAT-5 cable (user-supplied & the cable length depends on the on-site application and environment) to connect the EMS 1000 (EnviroProbe) to the EMS port on the UPS. For the location of the EMS port, please refer to **4.2 Communication Interfaces at the Rear of the Touch Panel**; for more information about installation of the optional EMS 1000 (EnviroProbe), please refer to **EnviroProbe 1000 Quick Guide**.
2. The UPS only supports RS485 communication mode. When installing the EMS 1000 (EnviroProbe), please set the device's communication mode as RS485 following **3-1 Comm DIP Switch Settings** of the **EnviroProbe 1000 Quick Guide**.
3. You have to assign a different ID # for each EMS 1000 (EnviroProbe) device connected to the UPS for the UPS to identify different devices. When installing the EMS 1000 (EnviroProbe), please set the ID # by the four ID DIP switches on the left of the device following **3-2 ID DIP Switch Settings** of the **EnviroProbe 1000 Quick Guide**.



NOTE:

1. You must set the ID # on the LCD according to the ID DIP switch setting on the EMS 1000 (EnviroProbe) device. Please refer to **7.10.10 EMS Setting**.
2. The ID # of each EMS 1000 (EnviroProbe) device connected to the UPS must be different.
3. When connecting more than one EMS 1000 (EnviroProbe) devices to the UPS, you don't have to set the ID # in numerical order.
4. To enable the EMS function of the UPS, you have to set up relevant items on the LCD after connecting the optional EMS 1000 (EnviroProbe) to the UPS. Please refer to **7.10.10 EMS Setting**.

7.10 UPS Settings

7.10.1 Bypass Setting

Path:  → Bypass Setting

After entering the **BYPASS SETTING** screen (shown in the figure below), you can set up the **Bypass Frequency Range**, **Bypass Voltage (Max.)**, **Bypass Voltage (Min.)** and **ECO Voltage Range**. If any value is out of range, the system will issue an alarm. These settings must be carried out by qualified service personnel. Please contact Delta customer service for assistance.

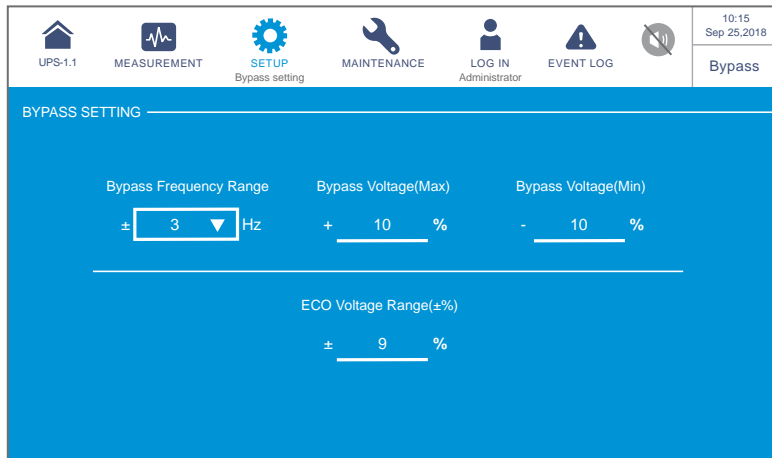



Item	Description
Bypass Frequency Range	Set up the bypass output's frequency range.
Bypass Voltage (Max.)	Set up the bypass output's maximum voltage.
Bypass Voltage (Min.)	Set up the bypass output's minimum voltage.
ECO Voltage Range	Set up the bypass output's voltage range in ECO mode.

7.10.2 Mode Setting

Path:  → Mode Setting

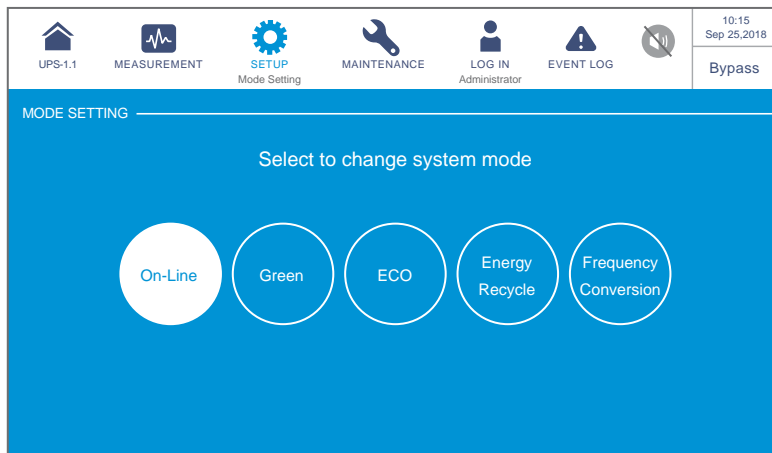
After entering the **MODE SETTING** screen (shown in the figure below), you can set up the UPS system mode, of which there are 5 options: **On-Line Mode**, **Green Mode**, **ECO Mode**, **Energy Recycle Mode** and **Frequency Conversion Mode**. These settings must be carried out by qualified service personnel. Please contact Delta customer service for assistance.



Item	Description
On-Line Mode	Set up the UPS in On-Line mode. In On-Line mode, it is the inverter to supply power to the connected loads.
Green Mode	Set up the UPS in Green mode. In Green mode, it is the inverter to supply power to the connected loads and the power modules take turn to rest according to the situation of total load capacity.
ECO Mode	Set up the UPS in ECO mode. In ECO mode, it is the bypass to supply power to the connected loads. It is suggested that you set the UPS in ECO mode only when there is stable main AC power. Otherwise, power supply quality will be compromised.
Energy Recycle Mode	Set up the UPS in Energy Recycle mode. In Energy Recycle mode, the full load output can be simulated for the aging test without real output to the loads.
Frequency Conversion Mode	<p>Set up the UPS in Frequency Conversion mode. In Frequency Conversion mode, it is the inverter to supply power to the connected loads with a fixed output frequency. Please note that the output will be terminated once the inverter is turned off.</p> <p> NOTE: Frequency Conversion mode is only applicable to single UPS but not to parallel UPSs.</p>

7.10.3 Output Setting

Path:  → **Output Setting**

After entering the **OUTPUT SETTING** screen (shown in the figure below), you can set up the following items. These settings must be carried out by qualified service personnel. Please contact Delta customer service for assistance.

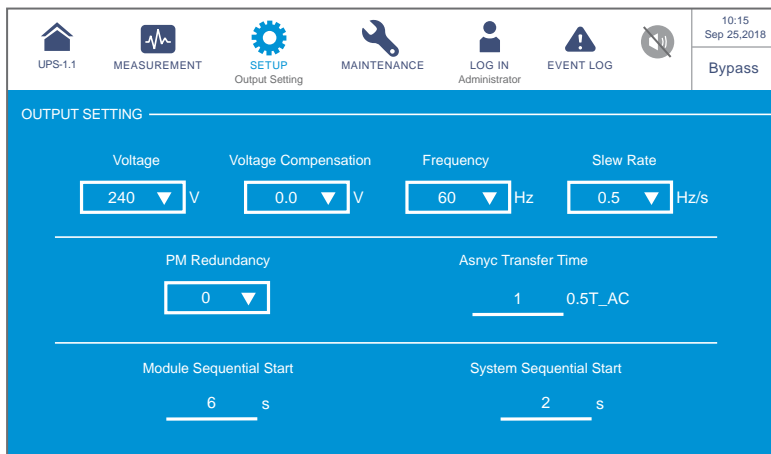

Item	Description
Voltage	Set up the output voltage.
Voltage Compensation	When the UPS is distant from the loads and there is a voltage drop in the output, you can adjust the INV output voltage amplitude for voltage compensation.
Frequency	Set up the output frequency as 50Hz (default) or 60Hz. The system will automatically select the output frequency in accordance with the bypass power.
Slew Rate	Set up the maximum permissible speed for the system output frequency to catch up with the bypass frequency variation.
Power Module Redundancy	Set up how many power modules that need to be preserved for redundancy.
Asynchronous Transfer Time	When (1) the inverter is not synchronized with the bypass and (2) the loads need to be transferred to the bypass source, there will be an interrupted transfer time according to this setup value.
Module Sequential Start	Set up the time interval for every power module to be transferred from Battery mode to On-Line mode. The setup will help the generator to handle the whole loads in a sequential manner to avoid generator shutdown due to sudden inrush current.
System Sequential Start	Set up the time interval for the system to be transferred from Battery mode to On-Line mode. The setup will help the generator to handle the whole loads in a sequential manner to avoid generator shutdown due to sudden inrush current.

7.10.4 Battery & Charging Setting

Path:  → **Battery & Charging Setting**

In the **BATTERY & CHARGING SETTING** screen (shown in the figure below), you can set up the following items. These settings must be carried out by qualified service personnel. Please contact Delta customer service for assistance.

UPS-1.1 MEASUREMENT SETUP Battery & Charging Setting MAINTENANCE LOG IN Administrator EVENT LOG Bypass 10:15 Sep 25, 2018					
BATTERY & CHARGING SETTING					
Battery Type <input type="text" value="PbAc"/>		Battery Rating Voltage <input type="text" value="240"/> V		Battery Strings <input type="text" value="1"/>	
Battery Low Warning <input type="text" value="220"/> V		Battery Cut Off Voltage <input type="text" value="210"/> V		Capacity <input type="text" value="450"/> A	
Float Charge Voltage <input type="text" value="272"/> V		Equalized Charge Voltage <input type="text" value="280"/> V		Charge Current (Max) <input type="text" value="45"/> A	
<input type="button" value="Submit"/>					



Whether it is 'Equalized Charge Voltage' or 'Restored Voltage' shown in this column, it is determined by 'Battery Type'. Please refer to the table shown in **Page 7-46** for more information.

UPS-1.1 MEASUREMENT SETUP Battery & Charging Setting MAINTENANCE LOG IN Administrator EVENT LOG Bypass 10:15 Sep 25, 2018					
BATTERY & CHARGING SETTING					
Auto Equalized Charge <input type="text" value="Disable"/>		Auto Equalized Charge Interval <input type="text" value="1 Month"/>		Equalized Charge Time <input type="text" value="480"/> min	

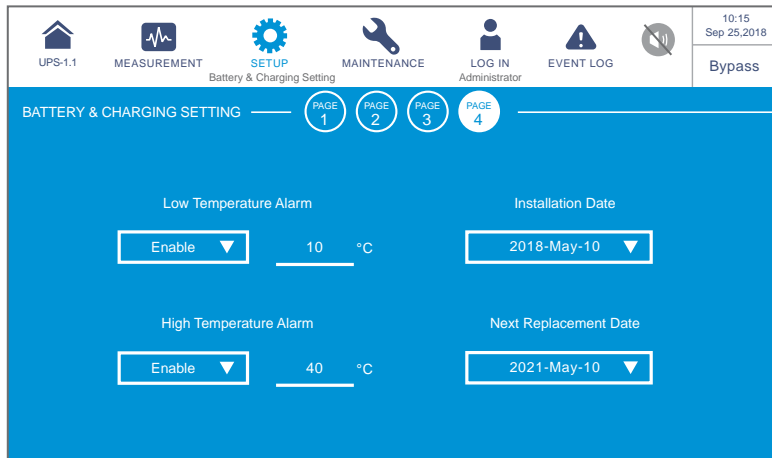
UPS-1.1 MEASUREMENT SETUP Battery & Charging Setting MAINTENANCE LOG IN Administrator EVENT LOG Bypass 10:15 Sep 25, 2018					
BATTERY & CHARGING SETTING					
Battery Test Fail Voltage <input type="text" value="0"/> V		Battery Test Duration <input type="text" value="3"/> min		Auto Battery Test Interval <input type="text" value="None"/>	



Item	Description
<p style="text-align: center;">Battery Type</p>	<p>Set up the battery type as VRLA/ LiB (Dry Contact)^{*1}/ LiB (Integration)^{*2}.</p> <p> NOTE:</p> <ol style="list-style-type: none"> ^{*1} If you use non-Delta lithium-ion batteries, please set up the battery type as 'LiB (Dry Contact)'. For relevant settings, please refer to 4.1.6 Input Dry Contacts and 7.10.6 Dry Contact Setting. For more information about configurations of the lithium-ion batteries, please contact Delta customer service. ^{*2} If you use the Delta lithium-ion batteries, please set up the battery type as 'LiB (Integration)'. The item 'LiB (Integration)' will only appear on the LCD if you use the Delta lithium-ion batteries with the optional multifunctional communication card (MFC) being installed in the SMART slot shown in Figure 4-13. Please contact Delta customer service if you need more information.
<p>Battery Rating Voltage</p>	<p>Set up the battery rating voltage.</p>
<p>Battery Strings</p>	<p>Set up how many battery strings that are used on site.</p>
<p>Battery Low Warning</p>	<p>Set up the battery low warning voltage.</p>

Item	Description
Battery Cut Off Voltage	Set up the battery low voltage. In Battery mode, when the battery low voltage is reached, the battery power will be cut off, and inverter of the UPS will shut down. The loads will then be transferred to bypass if the bypass is available; otherwise, the UPS will shut down.
Capacity	Set up the battery capacity.
Float Charge Voltage	Set up the float charge voltage.
Equalized Charge Voltage	Set up the equalized charge voltage.  NOTE: The item will only show up if the Battery Type is set as 'VRLA'.
Restored Voltage	Set up the restored voltage.  NOTE: 1. The item will only show up if the Battery Type is set as ' LiB (Integration) '. When the remaining battery voltage reaches the setup restored voltage, the UPS will automatically activate the charger to re-charge the batteries. 2. If the Battery Type is set as ' LiB (Dry Contact) ', the item will not show up.
Charge Current (Max)	Set up the maximum charge current.
Auto Equalized Charge	Enable or disable the auto-equalized charge.
Auto Equalized Charge Interval	Set up the auto equalized charge interval.
Equalized Charge Time	Set up the equalized charge time.
Battery Test Fail Voltage	Set up the battery test fail voltage. When the battery voltage is under the test fail voltage, it means battery fail.
Battery Test Duration	Set up how long the battery test should last.
Auto Battery Test Interval	Set up the battery test interval.
Low Temperature Alarm	Enable or disable the low temperature alarm. If enabled, set up the temperature.
High Temperature Alarm	Enable or disable the high temperature alarm. If enabled, set up the temperature.

Item	Description
Installation Date	Record the battery installation date.
Next Replacement Date	Set up the battery replacement date.

7.10.5 Parallel Setting

Path:  → Parallel Setting

After entering the **PARALLEL SETTING** screen (shown in the figure below), you can set up the following items. These settings must be carried out by qualified service personnel. Please contact Delta customer service for assistance.

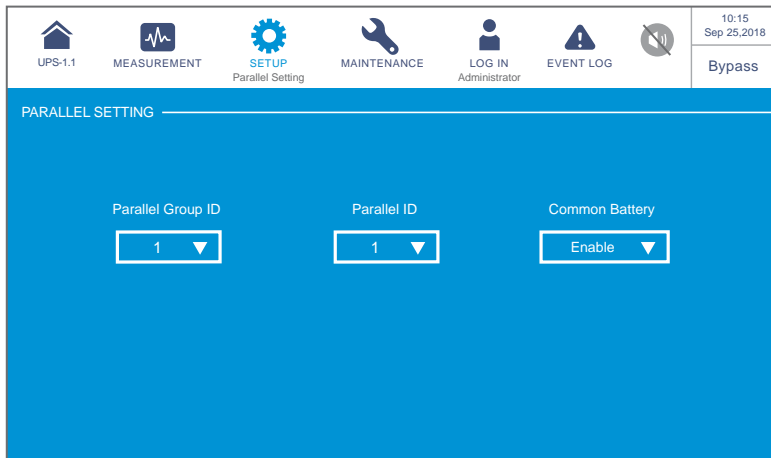

Item	Description
Parallel Group ID	The UPSs in parallel connection must be assigned the same parallel group ID No. in order to let the outputs of the parallel UPSs be put in parallel connection and let the loads be evenly distributed among the parallel units. If the parallel UPSs have different parallel group ID No., their output signals might be synchronized but their outputs cannot be connected in parallel.
Parallel ID	The UPSs that need to be paralleled must be assigned the same parallel group ID No. and different parallel ID No. in order to let the parallel function work.
Common Battery	If the parallel UPSs that have the same parallel group ID No. need to share common batteries, please select ' Enable ' for the ' Common Battery ' setup item. Otherwise, the function of battery abnormality detection will fail. For more information about common battery, please refer to 3.4 Common Battery (Only for Parallel UPSs connecting to the Same External Battery Cabinet(s)) .

7.10.6 Dry Contact Setting

Path:  → Dry Contact Setting

In the **DRY CONTACT SETTING** screen (shown in the figure below), the event, NO (normally open) or NC (normally closed) for each of the input and output dry contacts can be set up. These settings must be carried out by qualified service personnel. Please contact Delta customer service for assistance.

Input Dry Contact No.	Event Selection	Type
Input Dry Contact 1 Input Dry Contact 2 Input Dry Contact 3 Input Dry Contact 4	Select one of the following events as the setting for each input dry contact. <ol style="list-style-type: none"> 1. None 2. Generator status 3. Battery ground fail 4. External battery breaker detection 5. Charge Off (Positive) 6. Charge Off (Negative) 	Set up NO (normally open) or NC (normally closed) for each input dry contact.

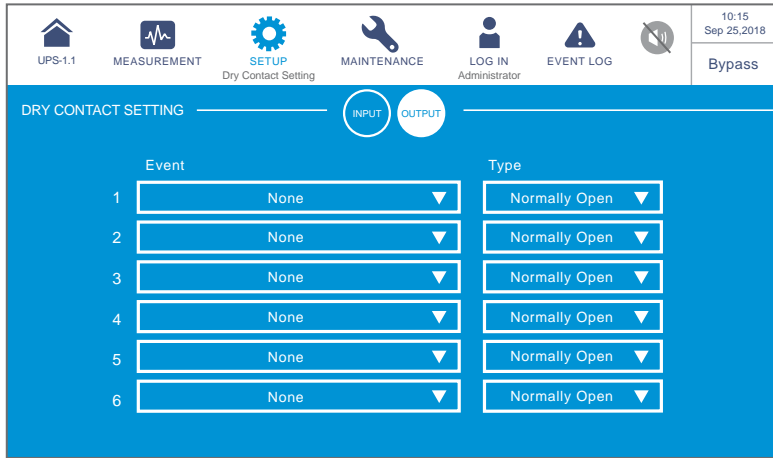

Output Dry Contact No.	Event Selection	Type
<p>Output Dry Contact 1 Output Dry Contact 2 Output Dry Contact 3 Output Dry Contact 4 Output Dry Contact 5 Output Dry Contact 6</p>	<p>Select one of the following events as the setting for each output dry contact.</p> <ol style="list-style-type: none"> 1. None 2. Load on inverter 3. Load on bypass 4. Load on battery 5. Battery low 6. Battery input abnormal 7. Battery test fail 8. Internal comm. fail 9. External parallel comm. fail (only applicable to parallel application) 10. Output overload 11. EPO activated 12. Load on manual bypass 13. Battery over temperature 14. Output voltage abnormal 15. Battery need replacement 16. Bypass over temperature 17. Bypass static switch fault 18. UPS over temperature 19. Battery breaker shunt trip 20. Backfeed protection 21. UPS general alarm 	<p>Set up NO (normally open) or NC (normally closed) for each output dry contact.</p>

7.10.7 General Setting



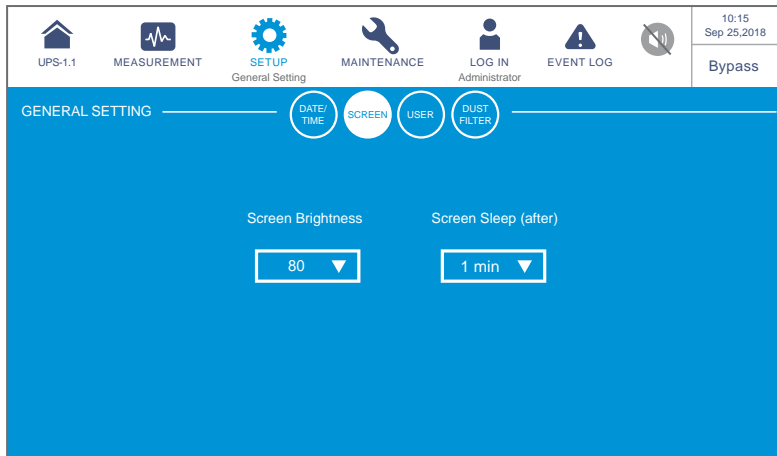
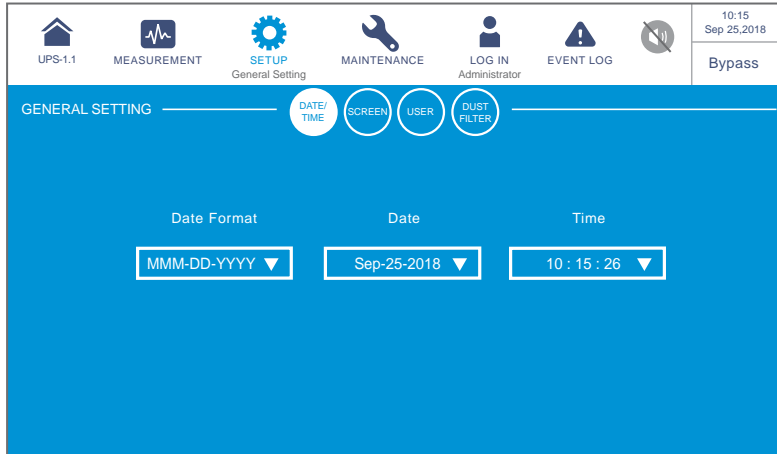

Path:  → **General Setting**

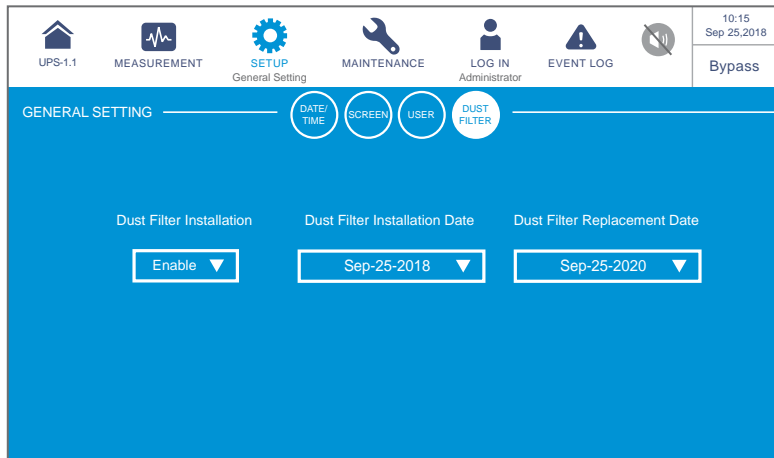
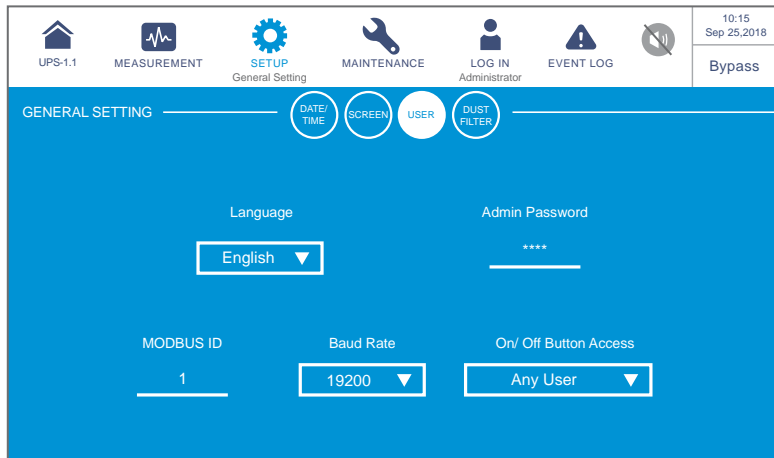
After entering the **GENERAL SETTING** screen (shown in the figure below), you can set up the following items.





Item	Sub Item	Description
DATE/ TIME	Date Format	Select the date format.
	Date	Set up the date.
	Time	Set up the time.
SCREEN	Screen Brightness	Adjust the LCD display brightness (default: 80).
	Screen Sleep (after)	Set up the LCD backlight sleep time (default: 1 minute).

Item	Sub Item	Description
USER	Language	Set up the display language (default: English).
	Admin Password	Set up the administrator password (4 digits).
	MODBUS ID	Set up the MODBUS ID for the MODBUS port located at the rear of the touch panel. For the location of the MODBUS port, see Figure 4-17 .
	Baud Rate	Set up the baud rate for the MODBUS port located at the rear of the touch panel. For the location of the MODBUS port, see Figure 4-17 .
	On/ Off Button Access	Set up the access for the ON/ OFF Button () as 'Any User' or 'Administrator Only'.
DUST FILTER	Dust Filter Installation	If you have installed any dust filter, please select 'Enable'; if not, please select 'Disable'.
DUST FILTER	Dust Filter Installation Date	Set up the dust filter installation date.  NOTE: Only when you select 'Enable' for 'Dust Filter Installation' can you set up the 'Dust Filter Installation Date'.
	Dust Filter Replacement Date	Set up the dust filter replacement date. When the date is due, the red warning icon () will automatically appear in the upper right corner of the LCD, and the alarm message 'Replace Dust Filter' will be displayed.  NOTE: Only when you select 'Enable' for 'Dust Filter Installation' can you set up the 'Dust Filter Installation Date'.



NOTE:

The screen () shown in the following figure will only appear on the LCD if you use the Delta lithium-ion batteries with the optional multifunctional communication (MFC) card being installed in the SMART slot shown in **Figure 4-13**. Please contact Delta customer service if you need more information.

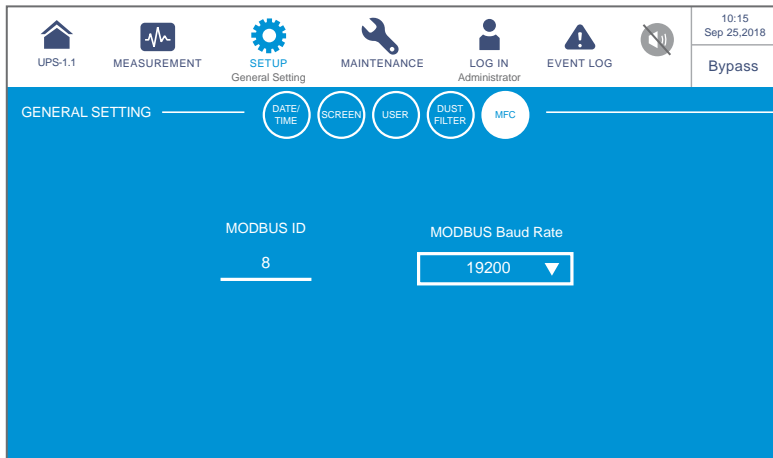

Item	Sub Item	Description
MFC	MODBUS ID	Set up the MODBUS ID for the optional multifunctional communication card (MFC).
	MODBUS Baud Rate	Set up the MODBUS baud rate for the optional multifunctional communication card (MFC).

7.10.8 IP Setting

Path:  → IP Setting

After entering the **IP SETTING** screen (shown in the figure below), you can set up the following items. These settings must be carried out by qualified service personnel. Please contact Delta customer service for assistance.

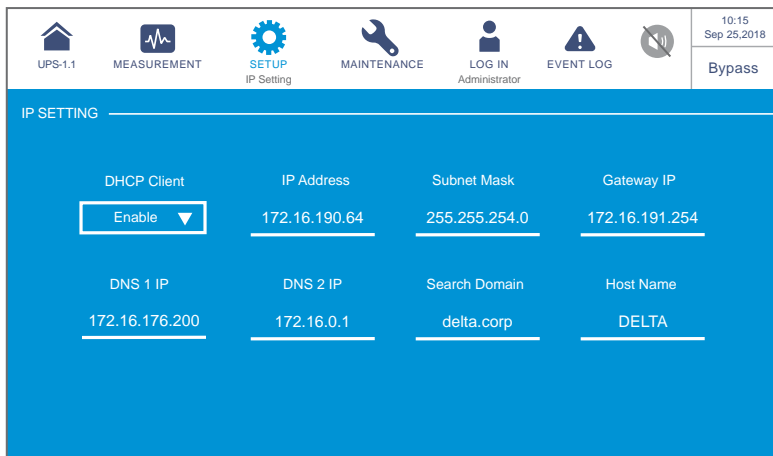

Item	Description
DHCP Client	Enable or disable the DHCP client.
IP Address	Set up the IP address.
Subnet Mask	Set up the subnet mask.
Gateway IP	Set up the gateway IP address.
DNS 1 IP	Set up the DNS server 1 IP address.
DNS 2 IP	Set up the DNS server 2 IP address.
Search Domain	Set up the search domain.
Host Name	Set up the host name.

7.10.9 Control

Path:  → Control

After entering the **CONTROL** screen (shown in the figure below), you can set up the following items. These settings must be carried out by qualified service personnel. Please contact Delta customer service for assistance.

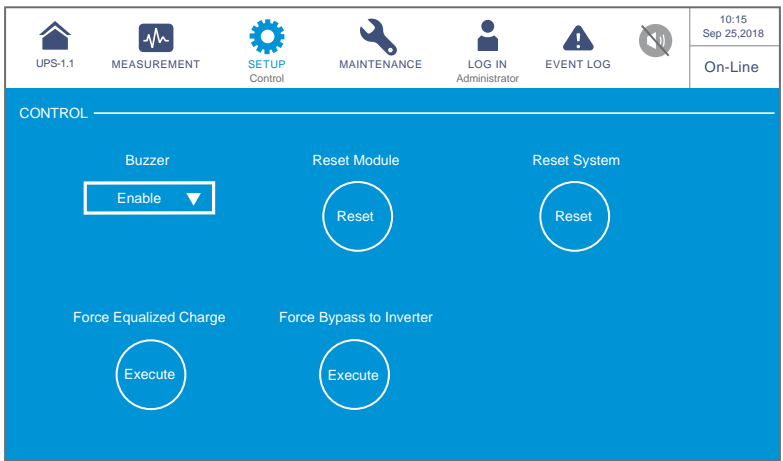

Item	Description
Buzzer	Enable or disable the buzzer.
Reset Module	Reset the power modules or not. In bypass mode, when you tap the ON/ OFF Button (⏻) to start up the UPS but the UPS does not respond, please select ' Reset ' to reset the power modules. After the power modules are reset, please tap the ON/ OFF Button (⏻) to start up the UPS.
Reset System	Reset the system or not. In bypass mode, when you tap the ON/ OFF Button (⏻) to start up the UPS but the UPS does not respond, please select ' Reset ' to reset the system. After the system is reset, please tap the ON/ OFF Button (⏻) to start up the UPS.
Force Equalized Charge	Manually force the UPS to run in auto equalized charge mode to charge the batteries.
Force Bypass to Inverter	Manually force the UPS to switch from bypass to inverter when the inverter keeps staying in the soft-start status and is unable to transfer to on-line mode successfully.

7.10.10 EMS Setting

Path:  → **EMS Setting**

After entering the **EMS SETTING** screen (shown in the figure below), you can set up the following items. These settings must be carried out by qualified service personnel. Please contact Delta customer service for assistance.

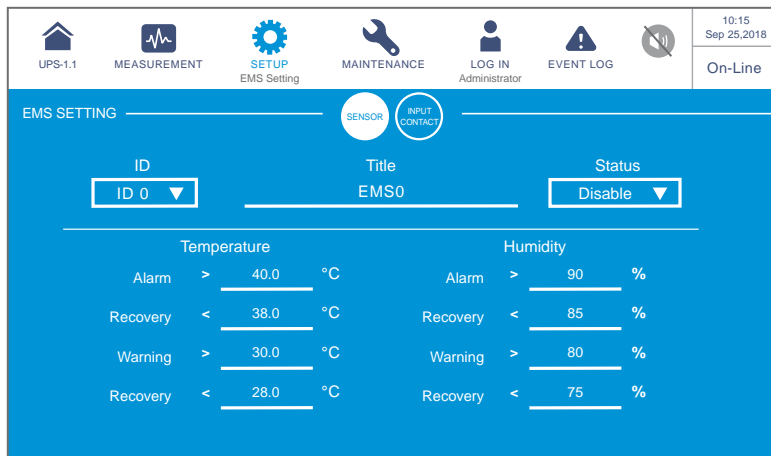

ID	Title	Status
ID 0	EMS0	Disable

Temperature		Humidity	
Alarm	> 40.0 °C	Alarm	> 90 %
Recovery	< 38.0 °C	Recovery	< 85 %
Warning	> 30.0 °C	Warning	> 80 %
Recovery	< 28.0 °C	Recovery	< 75 %



NOTE:

After connecting the optional EMS 1000 (EnviroProbe) to the UPS, you have to manually set both **ID** and **Status** to enable the EMS function of the UPS. Settings for the other items can be adjusted according to your needs; the default values are shown in the figures above.

All the settings in the table below are related to the items shown on the **EMS** screen in the  → **EMS**. Please refer to **7.9.7 EMS**.

Item	Sub Item	Description
SENSOR	ID	Set the ID # (ID 0/ ID 1/ .../ ID 15) according to the ID DIP switch setting of the EMS 1000 (EnviroProbe) device.  NOTE: If the ID # setting is wrong, the warning message 'The EMS 1000 ID # Communication Fail' will appear.
	Title	Set the title for each EMS 1000 (EnviroProbe) device.
	Status	The status Enable/ Disable determines whether or not the LCD shows the information of the EMS 1000 (EnviroProbe) device (ID #) on the screen.
	Temperature	Set the temperature (°C) values for Alarm/ Warning/ Recovery.
	Humidity	Set the humidity (%) values for Alarm/ Warning/ Recovery.

Item	Sub Item	Description
INPUT CONTACT	Input Contact 1	1. Set each input contact as Normally Open (NO)/ Normally Closed (NC). 2. Set the title for each input contact. 3. Set the event type as None/ Information/ Warning/ Alarm.
	Input Contact 2	
	Input Contact 3	
	Input Contact 4	



Not only does the **EMS** screen show status of the input contacts (please refer to **7.9.7 EMS**), but the **Warning** screen, **Historical Event** screen, UPS tri-color LED indicator and buzzer also response to the status of the input contacts.





Event Type of Input Contact	EMS DI1 ~ DI4 (LCD)	Tri-color LED Indicator	Buzzer	Warning (LCD)	Historical Event (LCD)
None	Green	Green	No Sound	No	No
Information	Green	Green	No Sound	No	Yes
Warning	Yellow	Yellow	Short Beep	Yes	Yes
Alarm	Red	Red	Long Beep	Yes	Yes

7.11 System Maintenance

7.11.1 Alarm Warning

Path 1:  MAINTENANCE → **Warning**

Path 2: When there is a warning, the buzzer icon () will light up in red, and the buzzer will make an alarm sound. Tap the warning icon () to enter the **WARNING** screen.

After entering the **WARNING** screen (shown in the figure below), you can use the (   ) icons to view the warning logs or use the function key () to enter a specific page No. to check the warning logs. The system can store up to 200 warning logs.



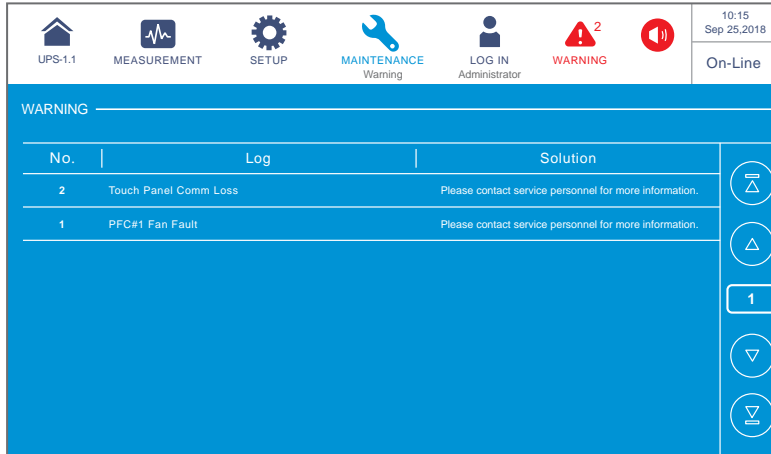

The **WARNING** screen also displays relevant solutions.



7.11.2 Historical Event

Path:  MAINTENANCE → **Historical Event**

The **HISTORICAL EVENT** screen shown below provides each historical event's No., start date and time, code (red: serious; orange: minor; green: normal), location, and log description. You can tap the icon () to magnify the entire historical event description.

You can use the icons (   ) to check the historical event logs or use the function key () to enter a specific page No. to view the historical event logs.

The system can save up to 10000 historical event logs. The greater the event number is, the newer the event is. When the total number of historical event logs exceeds the storage capacity (up to 10000 entries), the oldest 500 historical event logs will be overwritten.

You can tap the download icon () to download the historical event logs. To clear the historical event logs, please refer to **7.11.5 Clear**.

UPS-1.1
 MEASUREMENT
 SETUP
 MAINTENANCE
Historical Event
 LOG IN
Administrator
 WARNING ²

10:15
Sep 25, 2018
On-Line

HISTORICAL EVENT DOWNLOAD

No. ▲	Start Date	Code	Location	Log	
187	2017-10-15 10:27:07	3200-02	STS	Emergency PWR Off	
186	2017-10-15 10:26:52	2519-01	STS	CSU Aux Pwr #2 On Repair	
185	2017-10-15 10:26:36	2518-01	STS	CSU Aux Pwr #1 On Repair	
184	2017-10-15 09:06:59	0128-01	STS	Mains Input Freq Out Range	
183	2017-10-15 10:27:07	5005-01	STS	No Output	
182	2017-10-15 10:26:52	480A-01	STS	COM Card #2 Absent	
181	2017-10-15 10:26:36	0100-01	STS	Mains Input Volt Out Range	
180	2017-10-15 09:16:45	3200-01	STS	About Emergency PWR Off	

1

UPS-1.1
 MEASUREMENT
 SETUP
 MAINTENANCE
Historical Event
 LOG IN
Administrator
 WARNING ²

10:15
Sep 25, 2018
On-Line

HISTORICAL EVENT DOWNLOAD

No. ▲	Start Date	Code	Location	Log	
179	2017-10-15 09:06:59	480A-01	STS	Battery Disconnected	
178	2017-10-15 08:22:45	1021-01	STS	Mains Input Freq Out Range	
177	2017-10-15 08:10:06	2501-01	STS	Mains Input Volt Out Range	
176	2017-10-15 07:58:15	501F-01	STS	UPS Soft Start	
175	2017-10-15 07:48:22	5005-01	STS	No Output	
174	2017-10-15 07:35:10	480A-01	STS	COM Card #2 Absent	
173	2017-10-15 07:25:25	0100-01	STS	Mains Input Volt Out Range	
172	2017-10-15 07:15:02	3200-01	STS	About Emergency PWR Off	

2

7.11.3 Statistics

Path:  MAINTENANCE → Statistics

After entering the **STATISTICS** screen (shown in the figure below), you can view the following statistics.

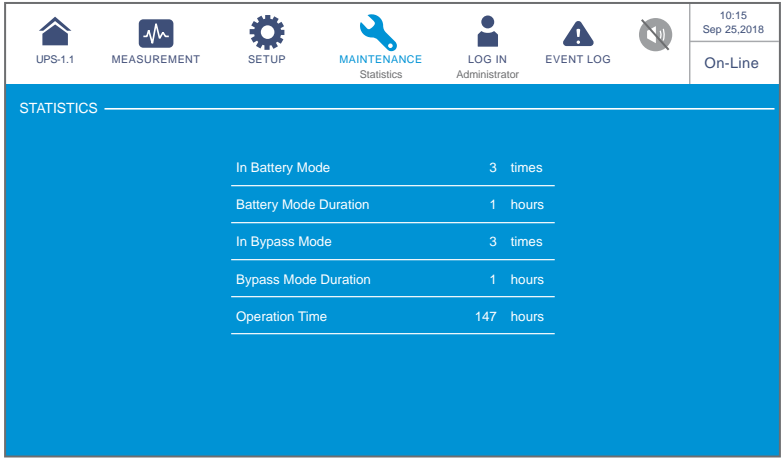

Item	Description
In Battery Mode	Means how many times that the UPS runs in battery mode.
Battery Mode Duration	Means how long the UPS runs in battery mode.
In Bypass Mode	Means how many times that the UPS runs in bypass mode.
Bypass Mode Duration	Means how long the UPS runs in bypass mode.
Operation Time	Means how long the UPS has operated.

To clear the statistics, please refer to **7.11.5 Clear**.

7.11.4 Test

Path:  MAINTENANCE → Test

After entering the **TEST** screen (shown in the figure below), you can perform a manual battery test.

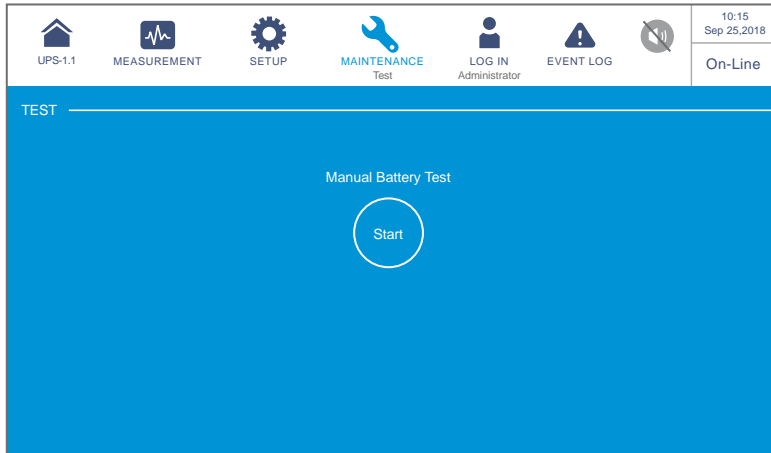

7.11.5 Clear

Path:  MAINTENANCE → **Clear**

After entering the **CLEAR** screen (shown in the figure below), you can clear the records of (1) statistics, (2) historical event, (3) battery test result and (4) kilowatt hour (kWh).



Item	Description
Clear Statistics	After you select ' Clear ' and confirm clearance of statistics, all records of the statistics will be cleared.
Clear Historical Event	After you select ' Clear ' and confirm clearance of historical event logs, all historical event logs will be cleared.

Item	Description
Clear Battery Test Result	After you select 'Clear' and confirm clearance of battery test result, the battery test result will be cleared.
Clear Kilowatt Hour (kWh)	After you select 'Clear' and confirm clearance of kilowatt hour records, the kilowatt hour statistics will be cleared.



NOTE:

The records of (1) statistics, (2) historical event, (3) battery test result, and (4) kilowatt hour (kWh) provide important information for system analysis and maintenance. Do not clear any of them without the consent of qualified service personnel.

7.11.6 Advanced Diagnosis

Path:  MAINTENANCE → **Advanced Diagnosis**

After entering the **ADVANCED DIAGNOSIS** screen (shown in the figure below), you can check:

1. STS temperature, battery temperature, and fan speed of the system.
2. INV temperature and PFC temperature of a specific battery module.

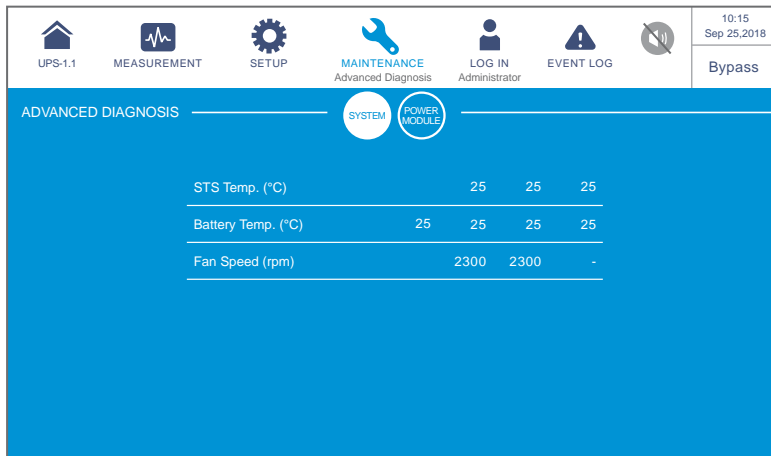

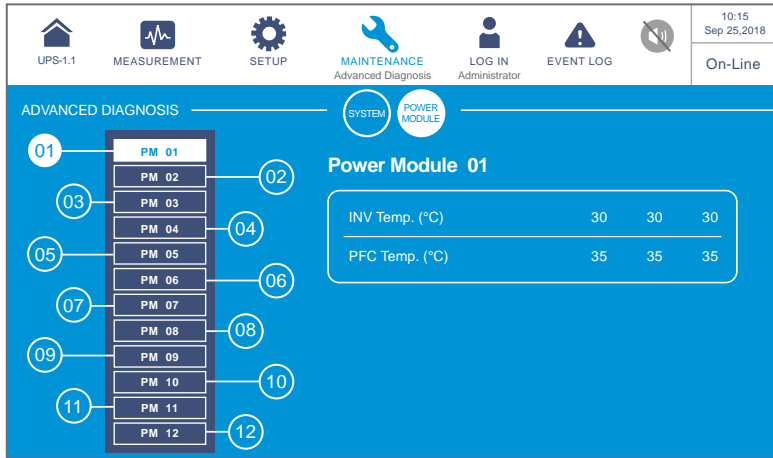

7.11.7 Version & S/N



NOTE:

To operate the UPS in parallel, please make sure the version and serial No. of each following item is the same for each parallel unit.

Path:  MAINTENANCE → **Version & S/N**

After entering the **VERSION & S/N** screen (shown in the figure below), you can check and update every version and serial number. For detailed information please refer to the table below.

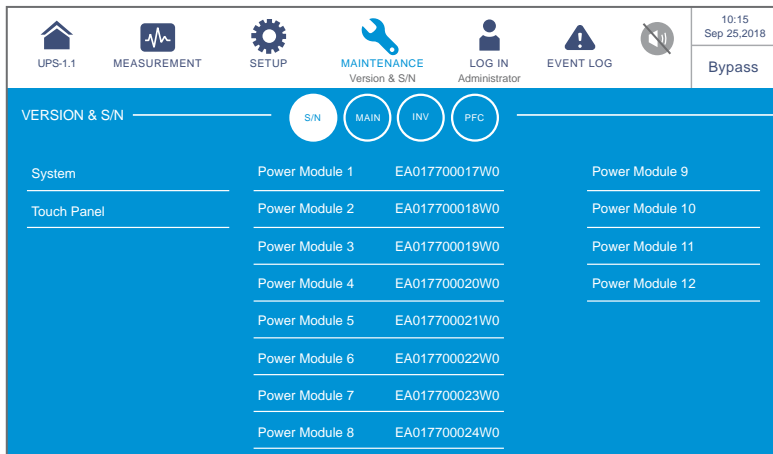

UPS-1.1 MEASUREMENT SETUP MAINTENANCE Version & S/N LOG IN Administrator EVENT LOG 10:15 Sep 25,2018 Bypass

VERSION & S/N S/N MAIN INV PFC

	MCU	FPGA
Parallel Communication Card #1	0H0017AR00.03.03	4A0000AR00.01.02
Parallel Communication Card #2	0H0017AR00.03.03	4A0000AR00.01.02
System Control Card	0H0017AR00.05.02	4A0000AR00.00.00
Touch Panel	00.130	

Choose File

UPGRADE

UPS-1.1 MEASUREMENT SETUP MAINTENANCE Version & S/N LOG IN Administrator EVENT LOG 10:15 Sep 25,2018 Bypass

VERSION & S/N S/N MAIN INV PFC

	MCU	FPGA	MCU	FPGA	
PM 01	0H0014AR00.00.00	4A001AR00.00.00	PM 02	0H0014AR00.00.00	4A001AR00.00.00
PM 03	0H0014AR00.00.00	4A001AR00.00.00	PM 04	0H0014AR00.00.00	4A001AR00.00.00
PM 05	0H0014AR00.00.00	4A001AR00.00.00	PM 06	0H0014AR00.00.00	4A001AR00.00.00
PM 07	0H0014AR00.00.00	4A001AR00.00.00	PM 08	0H0014AR00.00.00	4A001AR00.00.00
PM 09	0H0014AR00.00.00	4A001AR00.00.00	PM 10	0H0014AR00.00.00	4A001AR00.00.00
PM 11	0H0014AR00.00.00	4A001AR00.00.00	PM 12	0H0014AR00.00.00	4A001AR00.00.00

Choose File

UPGRADE

UPS-1.1 MEASUREMENT SETUP MAINTENANCE Version & S/N LOG IN Administrator EVENT LOG 10:15 Sep 25,2018 Bypass

VERSION & S/N S/N MAIN INV PFC

	MCU	FPGA	MCU	FPGA	
PM 01	0H0014AR00.07.00	4A001AR00.00.00	PM 02	0H0014AR00.07.00	4A001AR00.00.00
PM 03	0H0014AR00.07.00	4A001AR00.00.00	PM 04	0H0014AR00.07.00	4A001AR00.00.00
PM 05	0H0014AR00.07.00	4A001AR00.00.00	PM 06	0H0014AR00.07.00	4A001AR00.00.00
PM 07	0H0014AR00.07.00	4A001AR00.00.00	PM 08	0H0014AR00.07.00	4A001AR00.00.00
PM 09	0H0014AR00.07.00	4A001AR00.00.00	PM 10	0H0014AR00.07.00	4A001AR00.00.00
PM 11	0H0014AR00.07.00	4A001AR00.00.00	PM 12	0H0014AR00.07.00	4A001AR00.00.00

Choose File

UPGRADE

Item	Sub Item	Description
S/N	System	Check the system's serial No.
	Touch Panel	Check the touch panel's serial No.
	Power Module #	Check a specific power module's serial No.
MAIN	Parallel Communication Card #_ MCU/ FPGA	Check and update the MCU or FPGA firmware version of a specific parallel communication card.
	System Control Card_ MCU/ FPGA	Check and update the MCU or FPGA firmware version of the system control card.
	Touch Panel _ MCU	Check and update the touch panel's MCU firmware version.
INV	PM #_ MCU/ FPGA	Check and update the MCU or FPGA firmware version of a specific power module's inverter.
PFC	PM #_ MCU/ FPGA	Check and update the MCU or FPGA firmware version of a specific power module's PFC.



NOTE:

The screen () shown in the following figure will only appear on the LCD if you use the Delta lithium-ion batteries with the optional multifunctional communication card (MFC) being installed in the SMART slot shown in **Figure 4-13**. Please contact Delta customer service if you need more information.

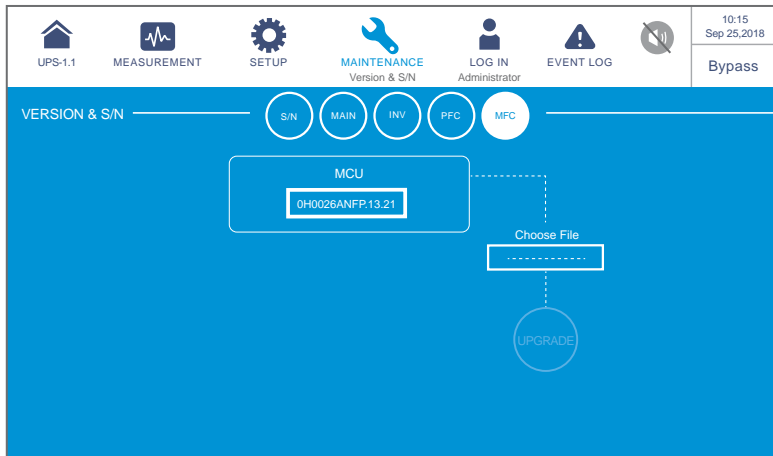

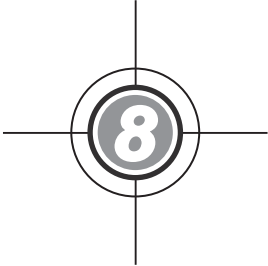

Item	Sub Item	Description
MFC	MCU	Check and update the MCU firmware version of the optional multifunctional communication card (MFC).



Optional Accessories

There are several optional accessories available for this DPH series UPS. Please refer to the table below for the optional accessories and their descriptions.

No.	Item	Function
1	Dust Filter	Prevents dust from entering into the UPS to ensure UPS reliability and to prolong product life.
2	Relay I/O Card	Increases the quantity of dry contacts.
3	EMS 1000 (EnviroProbe)	Monitors temperature, humidity and other connected monitoring devices in a room environment. Connect the EMS 1000 (EnviroProbe) to the UPS's EMS port located at the rear of the touch panel, and the UPS will integrate the detected information of the EMS 1000 (EnviroProbe) and display relevant data on the LCD. See Figure 4-17 for the location of the EMS port. For more information about the application of the EMS 1000 (EnviroProbe), please refer to 7.9.7 EMS and 7.10.10 EMS Setting .
4	Battery Cabinet Temperature Sensor Cable	Detects the temperature of an external battery cabinet connected to the UPS.
5	Parallel Cable (Length: 5 m (196.85"))	Connects the parallel UPSs.
6	Parallel Cable (Length: 10 m (393.7"))	Connects the parallel UPSs.
7	Battery Management System (BMS)	<p>If you use the lead-acid batteries, it is recommended to install the BMS to monitor (1) each battery's voltage, (2) each battery string's voltage and charging/ discharging current and (3) battery environment temperature.</p> <p>The BMS should be connected to the UPS's BMS port located at the rear of the touch panel (see Figure 4-17). For details, please refer to 7.9.6 Battery Status and 7.10.4 Battery & Charging.</p> <p> NOTE:</p> <p>The quantity of BMS to be installed depends on how many external battery cabinets (lead-acid batteries) are connected to the UPS. For BMS installation, please contact Delta customer service.</p>

No.	Item	Function
8	Fuse Box for External Battery	<p>When the UPS has a DC short circuit issue, the Fuse Box's internal fuses will blow and cut off the power connection between the UPS and the external battery cabinet for protection, which helps to reduce damages and avoid possible influence on other circuits.</p> <p> NOTE:</p> <ol style="list-style-type: none"> 1. If you use the lead-acid batteries, the number of batteries must be 40 for the Fuse Box application. 2. If you use the lithium-ion batteries, please contact Delta service personnel for relevant information.
9	Multifunctional Communication Card (MFC)	<p>If you use the Delta lithium-ion batteries, you must purchase and install the multifunctional communication card (MFC) in the SMART slot shown in Figure 4-13 to monitor the battery status via the UPS's LCD. For relevant information, please refer to 7.9.6 Battery Status, 7.10.4 Battery & Charging Setting, 7.10.7 General Setting and 7.11.7 Version & S/N. Please contact Delta customer service if you need more information.</p> <p> NOTE:</p> <p>For parallel UPSs, you must install one multifunctional communication card (MFC) in each parallel UPS if you use the Delta lithium-ion batteries.</p>

**NOTE:**

1. For details of installation and operation of the accessories mentioned above, please refer to the **Quick Guide**, **User Guide**, or **Installation & Operation Guide** included in the package of the relevant optional accessory.
2. If you want to purchase any accessories mentioned above, please contact your local dealer or customer service.



Maintenance

- **UPS**

1. UPS Cleaning:

Regularly clean the UPS, especially the slits, openings and filters, to ensure that the air freely flows into the UPS to avoid overheating. If necessary, use an air blower to clean the slits and openings and replace the filters regularly to prevent any object from blocking or covering these areas.

2. UPS Regular Inspection:

- a. Monthly check the filters and regularly replace them.
- b. Regularly check the UPS every half year and inspect:
 - 1) Whether the UPS, LED indicators, and alarm function normally.
 - 2) Whether the UPS works in bypass mode (normally, the UPS works in normal mode). If yes, check if any error, overload, internal fault, etc. occur.
 - 3) Whether the battery voltage is normal. If the battery voltage is too high or too low, find the root cause.

- **Batteries**

The DPH series UPS uses the lead-acid batteries or lithium-ion batteries. Make sure to replace batteries according to the battery life. However, the actual battery life depends on the environment temperature, usage, and charging/ discharging frequency. High temperature environments and high charging/ discharging frequency will quickly shorten the battery life; thus, battery inspection and maintenance are required periodically. Please follow the suggestions below to ensure normal battery life.

1. Keep usage temperature between 15°C ~ 25°C (59°F ~ 77°F).
2. When the UPS needs to be stored for an extended period of time, the lead-acid batteries must be recharged once every three months and the charging time must not be less than 24 hours each time. As for the lithium-ion batteries, please contact your battery supplier for the charging frequency and charging duration.

- **Fans**

Higher temperature will shorten fan life. When the UPS is running, please check if all fans work normally and make sure if air can move freely around and through the UPS. If not, please replace abnormal fans.



NOTE:

Please ask your local dealer or customer service for more maintenance information. Do not perform maintenance if you are not trained for it.

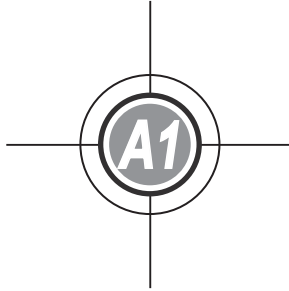

Technical Specifications

Model		DPH-600K				
UPS Capacity		200kVA/ 200kW	300kVA/ 300kW	400kVA/ 400kW	500kVA/ 500kW	600kVA/ 600kW
Power Module Q'ty		4	6	8	10	12
Input	Nominal Voltage	220/380 Vac, 230/400 Vac, 240/415 Vac (3Φ4W + G)				
	Voltage Range	176 ~ 276 Vac (full load)				
	Current Harmonic Distortion	≤ 3%* ¹				
	Power Factor	> 0.99				
	Frequency Range	40 ~ 70 Hz				
Output	Voltage	220/380 Vac, 230/400 Vac, 240/415 Vac (3Φ4W + G)				
	Voltage Harmonic Distortion	≤ 0.5% (linear load)				
	Power Factor	1				
	Frequency	50/60 Hz				
	Overload Capability	≤ 125%: 10 minutes; ≤ 150%: 1 minute; > 150%: 1 second				
Display		10" Touch Panel				
Interface	Standard	External battery temperature detection × 4, External switch/ breaker status dry contact × 4, Output dry contact × 6, Input dry contact × 4, Parallel port × 4, USB type A × 2, USB type B × 1, RS-232 port × 1, MODBUS port × 1, BMS (RJ45) × 1, Ethernet × 1, SMART slot × 1, REPO × 1				
Efficiency	Online Mode	up to 96.5%				
	ECO Mode	99%				
Battery	Nominal Voltage	± 240 Vdc (Default)				
	Charge Voltage	± 272 Vdc (adjustable from 204 Vdc to 312 Vdc)				
	Protection of Battery Deep Discharge	Yes				
Environment	Operating Altitude	1000 meters (3280 ft) (without derating)				
	Operating Temperature	0 ~ 40°C (32 ~ 104°F)				

Model		DPH-600K				
UPS Capacity		200kVA/ 200kW	300kVA/ 300kW	400kVA/ 400kW	500kVA/ 500kW	600kVA/ 600kW
Environment	Relative Humidity	95% (non-condensing)				
	Audible Noise	<75 dBA ^{*2}			< 80 dBA ^{*2}	< 85 dBA ^{*2}
	IP Degree of Protection	IP 20				
Others	Parallel Redundancy	Yes (up to 8 units)				
	Emergency Power Off	Yes (remote: default; local: optional)				
	Battery-start	Yes				
Physical	Dimensions (W x D x H)	1200 x 1100 x 2000 mm (47.24" x 43.31" x 78.74")				
	Weight	UPS: 605 kg (1333.8 lb) (without power modules)				
		Per power module (optional): 36 kg (81.6 lb)				
		753 kg (1660.1 lb)	828 kg (1825.4 lb)	902 kg (1988.6 lb)	976 kg (2151.7 lb)	1050 kg (2314.9 lb)



NOTE:

- *1: When input vTHD is < 1%.
- *2: At a distance of 1 meter (3.28 ft) in front of the UPS.
- Please refer to the rating label for the safety certification.
- All specifications are subject to change without prior notice.

The logo consists of a central circle containing the text 'A2'. This circle is surrounded by a larger, thin-lined circle. Four thin lines extend from the center of the circles to the top, bottom, left, and right edges of the page, forming a crosshair.

Warranty

Seller warrants this product, if used in accordance with all applicable instructions, to be free from original defects in material and workmanship within the warranty period. If the product has any failure problem within the warranty period, Seller will repair or replace the product at its sole discretion according to the failure situation.

This warranty does not apply to normal wear or to damage resulting from improper installation, operation, usage, maintenance or irresistible force (i.e. war, fire, natural disaster, etc.), and this warranty also expressly excludes all incidental and consequential damages.

Maintenance service for a fee is provided for any damage out of the warranty period. If any maintenance is required, please directly contact the supplier or Seller.



WARNING:

The individual user should take care to determine prior to use whether the environment and the load characteristic are suitable, adequate or safe for the installation and the usage of this product. The User Manual must be carefully followed. Seller makes no representation or warranty as to the suitability or fitness of this product for any specific application.

No. 501326930101
Version : V 1.1
Release Date : 2021_10_21

- Global Headquarter

Taiwan

Delta Electronics Inc.
39 Section 2, Huandong Road, Shanhua District,
Tainan City 74144, Taiwan
T +886 6 505 6565
E ups.taiwan@deltaww.com

- Regional Office

The United States

Delta Electronics (Americas) Ltd.
46101 Fremont Blvd. Fremont, CA 94538
T +1 510 344 2157
E ups.na@deltaww.com

Australia

Delta Energy Systems Australia Pty Ltd.
Unit 20-21, 45 Normanby Road, Notting Hill VIC 3168, Australia
T +61 3 9543 3720
E ups.australia@deltaww.com

South America

Delta Electronics Brasil Ltda.
Estrada Velha Rio São Paulo, 5300 Bairro Eugenio de Melo
12247-001 - São José dos Campos - SP - Brasil
T +55 12 3935-2300
E ups.brazil@deltaww.com

Thailand

Delta Electronics (Thailand) Public Co.,Ltd.
909 Soi 9, Moo 4, E.P.Z., Bangpoo Industrial Estate, Tambon Prakasa,
Amphur Muang-samutprakarn, Samutprakarn Province 10280, Thailand
T +662 709-2800
E ups.thailand@deltaww.com

China

Delta GreenTech (China) Co., Ltd.
238 Minxia Road, Pudong, Shanghai, 201209 P.R.C
T +86 21 5863 5678
+86 21 5863 9595
E ups.china@deltaww.com

South Korea

Delta Electronics (Korea), Inc.
1511, Byucksan Digital Valley 6-cha, Gasan-dong, Geumcheon-gu,
Seoul, Korea, 153-704
T +82-2-515-5303
E ups.south.korea@deltaww.com

Singapore

Delta Electronics Int'l (Singapore) Pte Ltd.
4 Kaki Bukit Ave 1, #05-04, Singapore 417939
T +65 6747 5155
E ups.singapore@deltaww.com

India

Delta Power Solutions (India) Pvt. Ltd.
Plot No. 43, Sector-35, HSIIDC, Gurgaon-122001, Haryana, India
T +91 124 4874 900
E ups.india@deltaww.com

EMEA

Delta Electronics (Netherlands) BV
Zandsteen 15, 2132MZ Hoofddorp, The Netherlands
T +31 20 655 09 00
E ups.netherlands@deltaww.com

Japan

Delta Electronics (Japan), Inc.
2-1-14 Shibadaimon, Minato-Ku, Tokyo, 105-0012, Japan
T +81-3-5733-1111
E jpstps@deltaww.com

UK

Delta Electronics Europe Limited
1 Redwood Court, Peel Park, East Kilbride, G74 5PF,
Scotland, United Kingdom
T +44 1355 588 888
E sales.gb@eltek.com



5013269301