

The power behind competitiveness

Delta UPS - Modulon Family

DPH Series, Three Phase
15-105 kVA 208 Vac

User Manual

SAVE THIS MANUAL

This manual contains important instructions and warnings that you should follow during the installation, operation, storage and maintenance of this product. Failure to heed these instructions and warnings will void the warranty.

Copyright © 2020 by Delta Electronics Inc. All Rights Reserved. All rights of this User Manual ("Manual"), including but not limited to the contents, information, and figures are solely owned and reserved by Delta Electronics Inc. ("Delta"). The Manual can only be applied to the operation or the use of this product. Any disposition, duplication, dissemination, reproduction, modification, translation, extraction, or usage of this Manual in whole or in part is prohibited without the prior written permission of Delta. Given that Delta will continuously improve and develop the product, changes may be made to the information in this Manual at any time without obligation to notify any person of such revision or changes. Delta will make all possible efforts to secure the accuracy and the integrity of this Manual. Delta disclaims any kinds or forms of warranty, guarantee, or undertaking, either expressly or implicitly, including but not limited to the completeness, faultlessness, accuracy, non-infringement, merchantability or fitness for a particular purpose of the Manual.

Table of Contents

1.	Important Safety Instructions	1-1
1.1	Installation Warnings	1-2
1.2	Connection Warnings	1-2
1.3	Usage Warnings	1-3
1.4	Storage Warnings	1-5
1.5	Standard Compliance	1-5
2.	Introduction	2-1
2.1	General Overview	2-2
2.2	Package Inspection	2-2
2.3	Functions & Features	2-4
2.4	Exterior and Dimensions	2-6
2.5	Front View	2-7
2.6	Internal View	2-8
2.7	Tri-color LED Indicator & Buzzer	2-12
3.	Operation Modes	3-1
3.1	Single Input	3-2
3.1.1	On-Line Mode_ Single Input_ Single Unit	3-2
3.1.2	Battery Mode_ Single Input_ Single Unit	3-3
3.1.3	Bypass Mode_ Single Input_ Single Unit	3-4
3.1.4	Manual Bypass Mode_ Single Input_ Single Unit	3-4
3.1.5	ECO Mode_ Single Input_ Single Unit	3-6
3.1.6	Frequency Conversion Mode_ Single Input_ Single Unit	3-6
3.1.7	Green Mode_ Single Input_ Single Unit	3-7
3.1.8	Energy Recycle Mode_ Single Input_ Single Unit	3-8
3.1.9	On-Line Mode_ Single Input_ Parallel Units	3-9
3.1.10	Battery Mode_ Single Input_ Parallel Units	3-10
3.1.11	Bypass Mode_ Single Input_ Parallel Units	3-11
3.1.12	Manual Bypass Mode_ Single Input_ Parallel Units	3-12
3.1.13	ECO Mode_ Single Input_ Parallel Units	3-14
3.2	Dual Input	3-15
3.2.1	On-Line Mode_ Dual Input_ Single Unit	3-15
3.2.2	Battery Mode_ Dual Input_ Single Unit	3-15
3.2.3	Bypass Mode_ Dual Input_ Single Unit	3-16
3.2.4	Manual Bypass Mode_ Dual Input_ Single Unit	3-17

3.2.5	ECO Mode_ Dual Input_ Single Unit-----	3-18
3.2.6	Frequency Conversion Mode_ Dual Input_ Single Unit-----	3-19
3.2.7	Green Mode_ Dual Input_ Single Unit-----	3-20
3.2.8	On-Line Mode_ Dual Input_ Parallel Units -----	3-21
3.2.9	Battery Mode_ Dual Input_ Parallel Units-----	3-22
3.2.10	Bypass Mode_ Dual Input_ Parallel Units -----	3-23
3.2.11	Manual Bypass Mode_ Dual Input_ Parallel Units-----	3-24
3.2.12	ECO Mode_ Dual Input_ Parallel Units-----	3-26
3.3	Hot Standby Redundancy (Only For Dual Input & At Least Two UPSs)----	3-27
3.4	Common Battery (Only for Parallel UPSs connecting to the Same External Battery Cabinet(s)) -----	3-28

4. Communication Interfaces ----- 4-1

4.1	Communication Interfaces on the Front of the UPS with Front Door Open -----	4-2
4.1.1	Display Port-----	4-3
4.1.2	REPO Dry Contacts -----	4-4
4.1.3	External Battery Temperature Dry Contacts-----	4-5
4.1.4	External Switch/ Breaker Status Dry Contacts -----	4-6
4.1.5	Output Dry Contacts-----	4-7
4.1.6	Input Dry Contacts -----	4-10
4.1.7	Parallel Communication Cards -----	4-11
4.1.8	Parallel Ports -----	4-12
4.1.9	SMART Slot -----	4-12
4.1.10	USB Port & RS-232 Port -----	4-13
4.1.11	Auxiliary Power Cards -----	4-13
4.1.12	Battery Start Buttons -----	4-14
4.2	Communication Interfaces at the Rear of the Touch Panel -----	4-14

5. Installation and Wiring ----- 5-1

5.1	Before Installation and Wiring -----	5-2
5.2	Installation Environment -----	5-2
5.3	UPS Transportation -----	5-4
5.4	Fixing the UPS -----	5-5
5.5	Wiring-----	5-7
5.5.1	Pre-wiring Warnings-----	5-7
5.5.2	Single Input/ Dual Input Modification-----	5-10
5.5.3	Single Unit Wiring-----	5-12
5.5.4	Parallel Unit Wiring -----	5-18

5.6	External Battery Cabinet Connection Warnings -----	5-20
5.7	STS Module -----	5-26
5.7.1	STS Module Installation -----	5-27
5.7.2	STS Module Removal -----	5-29
5.7.3	STS Module's LED Indicator -----	5-31
5.8	Power Module (Optional) -----	5-32
5.8.1	Power Module Installation -----	5-33
5.8.2	Power Module Removal -----	5-35
5.8.3	Power Module's LED Indicator -----	5-38
6.	UPS Operation-----	6-1
6.1	Pre Start-up & Pre Turn-off Warnings for Single Unit and Parallel Units -----	6-2
6.2	Start-up Procedures -----	6-4
6.2.1	On-Line Mode Start-up Procedures -----	6-4
6.2.2	Battery Mode Start-up Procedures -----	6-7
6.2.3	Bypass Mode Start-up Procedures -----	6-10
6.2.4	Manual Bypass Mode Start-up Procedures -----	6-13
6.2.5	ECO Mode Start-up Procedures -----	6-18
6.2.6	Frequency Conversion Mode Start-up Procedures -----	6-22
6.2.7	Green Mode Start-up Procedures -----	6-25
6.2.8	Energy Recycle Mode Start-up Procedures -----	6-29
6.3	Turn-off Procedures -----	6-32
6.3.1	On-Line Mode Turn-off Procedures -----	6-32
6.3.2	Battery Mode Turn-off Procedures -----	6-34
6.3.3	Bypass Mode Turn-off Procedures -----	6-36
6.3.4	Manual Bypass Mode Turn-off Procedures -----	6-37
6.3.5	ECO Mode Turn-off Procedures -----	6-37
6.3.6	Frequency Conversion Mode Turn-off Procedures -----	6-40
6.3.7	Green Mode Turn-off Procedures -----	6-43
6.3.8	Energy Recycle Mode Turn-off Procedures -----	6-45
7.	LCD Display & Settings -----	7-1
7.1	LCD Display Hierarchy -----	7-2
7.2	How to Turn on the LCD -----	7-3
7.3	ON/ OFF Button -----	7-5
7.4	Introduction of Touch Panel and Function Keys -----	7-7
7.5	Password Entry -----	7-12
7.6	Main Screen -----	7-12

7.7	Main Menu -----	7-17
7.8	Power Flow, Summary, System Status & EMS -----	7-18
7.9	Check System Readings -----	7-21
7.9.1	Main Input-----	7-21
7.9.1.1	Check Kilowatt-Hour -----	7-21
7.9.2	Bypass Input -----	7-32
7.9.3	Inverter Output-----	7-32
7.9.4	Power Module Summary-----	7-33
7.9.5	UPS Output-----	7-33
7.9.6	Battery Status-----	7-34
7.9.7	EMS -----	7-35
7.9.7.1	Connecting the optional EMS 1000 (EnviroProbe)-----	7-38
7.10	UPS Settings -----	7-38
7.10.1	Bypass Setting-----	7-38
7.10.2	Mode Setting -----	7-39
7.10.3	Output Setting-----	7-41
7.10.4	Battery & Charging Setting -----	7-42
7.10.5	Parallel Setting-----	7-45
7.10.6	Dry Contact Setting -----	7-46
7.10.7	General Setting -----	7-48
7.10.8	IP Setting-----	7-50
7.10.9	Control -----	7-51
7.10.10	EMS Setting -----	7-52
7.11	System Maintenance -----	7-54
7.11.1	Alarm Warning -----	7-54
7.11.2	Historical Event-----	7-55
7.11.3	Statistics-----	7-56
7.11.4	Test -----	7-57
7.11.5	Clear-----	7-57
7.11.6	Advanced Diagnosis -----	7-58
7.11.7	Version & S/N -----	7-59
8.	Optional Accessories -----	8-1
9.	Maintenance-----	9-1
10.	Troubleshooting -----	10-1
	Appendix 1 : Technical Specifications-----	A1-1
	Appendix 2 : Warranty-----	A2-1

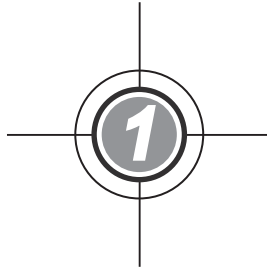

Important Safety Instructions

1.1 Installation Warnings

1.2 Connection Warnings

1.3 Usage Warnings

1.4 Storage Warnings

1.5 Standard Compliance

1.1 Installation Warnings

- This is a three-phase four-wire on-line uninterruptible power supply (hereafter referred to as 'UPS'). It can be used for commercial and industrial applications.
- Install the UPS in a well-ventilated indoor area, away from excess moisture, heat, dust, flammable gas or explosives.
- Leave adequate space around all sides of the UPS for proper ventilation and maintenance. Please refer to **5.2 Installation Environment**.
- Only authorized Delta engineers or service personnel can perform installation and maintenance. If you want to install the UPS by yourself, please install it under the supervision of authorized Delta engineers or service personnel.
- All wiring and equipment should be connected and installed in accordance with NFPA 70, National Electrical Code (NEC), and the applicable sections of ANSI C2, National Electrical Safety Code (NESC). It is the responsibility of the Authority Having Jurisdiction over the final installation to determine if the final configuration meets the necessary criteria for installation and use.

1.2 Connection Warnings

- Before applying electrical power to the UPS, make sure the UPS is grounded to avoid a possible risk of current leakage.
- You can parallel four UPS units.
- The UPS must be connected with an external battery cabinet (user-supplied, handled and configured by Delta service personnel). Please refer to **5.6 External Battery Cabinet Connection Warnings** for relevant information.
- The installation of protective devices is highly recommended when the UPS is connected to power sources and critical loads.
- The protective devices connecting to the UPS must be installed near the UPS and easily accessible for operation.
- Protective Devices:
 1. For single input, please install (1) a protective device between the main AC source and the UPS and (2) a protective device between the connected critical loads and the UPS.
 2. For dual input, please install (1) a protective device between the main AC source and the UPS, (2) a protective device between the bypass source and the UPS, and (3) a protective device between the connected critical loads and the UPS.

3. Each protective device could be a breaker or a fuse. For the protective device's rating current, please refer to the table below.

15kVA	30kVA	45kVA	60kVA	75kVA	90kVA	105kVA
60A	125A	175A	225A	300A	350A	400A

4. When selecting the protective devices, please take each power cable's current capacity and the system's overload capacity (please refer to **Appendix 1: Technical Specifications**) into consideration. Besides, the short-circuit capacity of the upstream protective devices must be equal to or larger than the capacity of the UPS's input protective devices.
5. If the UPS is supplied by a power source whose neutral is grounded, the backfeed protective device installed as UPS input protection must be a 3-pole type. If the UPS is supplied by a power source whose neutral is not grounded, the backfeed protective device installed as UPS input protection must be a 4-pole type.
6. The recommended electrical rating of the backfeed protective device is as follows.

15kVA	30kVA	45kVA	60kVA	75kVA	90kVA	105kVA
240V/ 60A	240V/ 125A	240V/ 175A	240V/ 225A	240V/ 300A	240V/ 350A	240V/ 400A

1.3 Usage Warnings

- Before installation, wiring and working on the UPS's internal circuits, please completely cut off all power supplying to the UPS, including the input power and battery power.
- The UPS is specifically designed for information technology equipment and used to power computers, servers, and associated peripheral devices. If you want to connect any capacitive loads or non-linear loads (that have serious surge current) to the UPS, it needs to be de-rated according to on-site applications. For such special applications, please contact Delta service personnel for the accurate UPS sizing. The UPS is not suitable for connecting with any asymmetrical loads.
- The external slits and openings in the UPS are provided for ventilation. To ensure reliable operation of the UPS and to protect the UPS from overheating, these slits and openings must not be blocked or covered. Do not insert any object into the slits and openings that may hinder ventilation.
- Before applying electrical power to the UPS, you must allow the UPS to adjust to room temperature 68 °F ~ 77 °F (20°C ~ 25°C) for at least one hour to avoid moisture condensing inside the UPS.

- Do not put beverages on the UPS, external battery cabinet(s) or any other accessory associated with the UPS.
- Do not open or remove the covers or panels of the UPS to avoid high voltage electric shock. Only authorized Delta engineers or service personnel can do so for installation or maintenance. If you want to open or remove the covers or panels, do it only under the supervision of authorized Delta engineers or service personnel.
- It is strictly forbidden to connect the UPS to any regenerative loads.
- The risk of dangerous high voltage is possible when batteries are still connected to the UPS even though the UPS is disconnected from the power sources. Before maintenance, turn off each external battery cabinet's circuit breaker to completely cut off the battery power from the UPS.
- Do not dispose of the battery or batteries in a fire. The batteries may explode.
- Do not open or damage the battery or batteries. The released electrolyte is harmful to the skin and eyes and may be toxic.
- The UPS is electronic equipment that runs 24 hours continuously. To ensure its normal lifetime, regular maintenance of the UPS and batteries is of vital importance and necessary.
- Some components like batteries, power capacitors, and fans will become worn-out due to long-term usage, and this will increase the risk of UPS failure. To replace and maintain the components, please contact Delta service personnel.
- A battery can present a risk of electric shock and high short-circuit current. The following precautions should be observed before replacement of batteries:
 1. Remove watches, rings, or other metal objects.
 2. Use tools with insulated handles.
 3. Wear insulating gloves and boots.
 4. Do not lay tools or metal parts on the top of batteries.
 5. Disconnect the charging source prior to connecting or disconnecting the batteries' terminals.
- You must contact Delta customer service if either of the following events occurs:
 1. Liquid is poured or splashed on the UPS.
 2. The UPS is deformed.
 3. Any conductive powders or metals enter into the UPS.
 4. The UPS does not run normally after carefully following the instructions in this ***User Manual***.

1.4 Storage Warnings

- Use the original packing material to pack the UPS to prevent any possible damage from rodents.
- If the UPS needs to be stored prior to installation, it should be placed in a dry indoor area. The allowable storage temperature is below 158 °F (70 °C) and relative humidity is below 95%.

1.5 Standard Compliance

- UL
- FCC Part 15 Class A

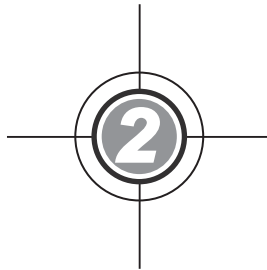



Introduction

- 2.1 General Overview
- 2.2 Package Inspection
- 2.3 Functions & Features
- 2.4 Exterior and Dimensions
- 2.5 Front View
- 2.6 Internal View
- 2.7 Tri-color LED Indicator & Buzzer

2.1 General Overview

The DPH series UPS, a three-phase four-wire online uninterruptible power supply (hereafter referred to as 'UPS'), is a dedicated design for data centers, factory facilities and large scale power systems. The unit not only adopts advanced IGBT technology to provide high quality, low noise, pure and uninterruptible output power to the connected loads, but also applies the latest design of DSP digital control technology and highest quality components.

The UPS supports high efficient operation modes and its modular and hot-swappable design makes maintenance easy and quick. You can add power modules (optional) according to on-site applications to expand overall system capacity, which realizes a highly cost-effective solution to your power requirements and produces greater electric power efficiency at less cost.

The unit provides diversified communication interfaces, including the network port  and MODBUS port  for you to facilitate remote control and management. You can parallel four UPS units to increase the system capacity and redundancy and enhance the unit's availability and reliability. With the installation of UPSentry 2012 software (<https://datacenter-softwarecenter.deltaww.com.cn>), you can monitor several UPSs placed in a computer room or a factory to facilitate centralized control and save manpower.

2.2 Package Inspection

- External

During UPS transportation, some unpredictable situations might occur. It is recommended that you inspect the UPS exterior packaging. If you notice any damage, please immediately contact the dealer from whom you purchased the unit.

- Internal

1. Check the rating label attached to the UPS and make sure the device No. and capacity match what you ordered.
2. Examine if any parts are loose or damaged.
3. The UPS package contains the following items. Please check if any items are missing.

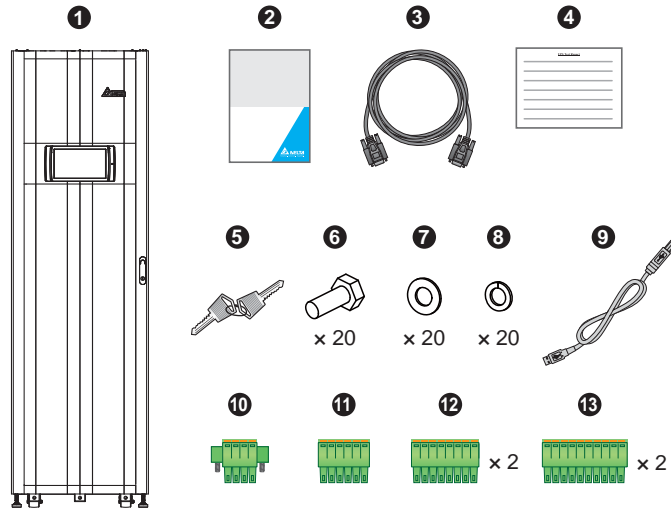

No.	Item	Q'ty
①	UPS	1 PC
②	User Manual	1 PC
③	Parallel Cable (3 meters)	1 PC
④	Test Report	1 PC
⑤	Key	1 PC (two copies placed inside the UPS cabinet)
⑥	M10 Screw (used for input/ output/ battery/ grounding wiring)	20 PCS
⑦	Washer (used for input/ output/ battery/ grounding wiring)	20 PCS
⑧	Spring Washer (used for input/ output/ battery/ grounding wiring)	20 PCS
⑨	USB Cable	1 PC
⑩	4-Pin Dry Contact Terminal Block (used for REPO dry contacts; please refer to <i>Figure 4-3</i>)	1 PC

No.	Item	Q'ty
11	6-Pin Dry Contact Terminal Block (used for MODBUS and BMS ports located at the rear of the touch panel; please refer to Figure 4-17)	1 PC
12	8-Pin Dry Contact Terminal Block (used for (1) external battery temperature dry contacts and (2) external switch/ breaker status dry contacts; please refer to Figure 4-3)	2 PCS
13	10-Pin Dry Contact Terminal Block (used for input and output dry contacts; please refer to Figure 4-3)	2 PCS

4. If there is any damage or anything missing, please immediately contact the dealer from whom you purchased the unit.
5. If the UPS needs to be returned, carefully repack the UPS and all of the accessories using the original packing material that came with the unit.

2.3 Functions & Features

- Hot swappable STS module, communication interfaces and power modules (optional) realize on-line maintenance, reduce the MTTR (Mean Time to Repair) and expand system capacity flexibly (15 ~ 105kVA).
- Input power factor > 0.99 and input THDi ≤ 3% save on installation cost and diminish power contamination.
- Output power factor=1.
- High efficiency performance saves on operation cost (95% for normal input).
- Input frequency detection enables operation at 40Hz ~ 70Hz.
- Automatic restart
 1. The UPS will restart in normal mode automatically right after the AC line resumes following a low battery shutdown.
 2. The UPS returns automatically to normal mode from bypass mode after an overload condition is cleared.
- Automatically detects whether bypass voltage is out of rating voltage (default: voltage ±15% & frequency ±3Hz). If yes, the UPS will stop supplying power to the critical loads to protect your electronic equipment.

- Supports ECO mode: when input voltage and frequency are within the range of rating voltage $\pm 10\%$ and rating frequency $\pm 3\text{Hz}$, the UPS will transfer to bypass mode; otherwise, the UPS will transfer to normal mode to reach higher efficiency.
- Both auxiliary power and control circuit adopt redundancy design, which doubly enhances UPS reliability.
- Adopts top cable entry.
- Generator compatible.
- Surge protection and EMI filter functions.
- Remote emergency power off.
- Single input and dual input functions.
- Supports external switch/ breaker status detection.
- Wide AC input voltage range (full load: 96 Vac ~ 146 Vac; < 70% load: 72 Vac ~ 96 Vac) reduces frequent transfer from normal mode to battery mode to save battery consumption and prolong battery life.
- Battery start-up function even when there is no AC input.
- AC start-up function even when the UPS is not connected to the batteries.

**WARNING:**

Please note that when the UPS is not connected to the batteries, it will not protect your equipment if the utility power is lost.

- Connects at maximum four external battery cabinets to extend backup time.
- Schedulable battery test and battery replacement alarm.
- Battery temperature monitoring and compensation.
- Optional battery management system (BMS) allows measurement of every battery's voltage.
- Smart battery charger design allows auto-charging or manual charging to shorten charging time.
- Provides communication interfaces and a smart slot. Please refer to **4. Communication Interfaces**.
- Built-in RS-232 port and USB port located on the communication interfaces allow monitoring and management of the UPS. For relevant location and information, please refer to **Figure 4-3** and **Page 4-13**.

- Built-in SNMP card and MODBUS card located at the rear of the touch panel provide network communication and MODBUS communication respectively. Besides, the SNMP card allows remote monitoring, management and event log download of the UPS. For relevant location and information, please refer to **Figure 4-17** and **Page 4-15**.
- Built-in USB ports () located at the rear of the touch panel allow upgrade of the UPS, touch panel, power modules, system control card and parallel communication cards' firmware and event log download. For relevant location and information, please refer to **Page 4-17** and **Page 4-15**.
- Built-in SRAM records at maximum 10000 event logs.
- 10-inch graphic and color touch panel enables users to easily operate the UPS and understand the UPS status.
- Fan speed auto adjustment prolongs fan life and reduces noise when the critical loads decrease. Moreover, fan failure detection circuit is established.
- State-of-the-art microprocessor technology performs self-detection and monitors fan speed in real time, which provides complete and detailed operating status of the UPS.

2.4 Exterior and Dimensions

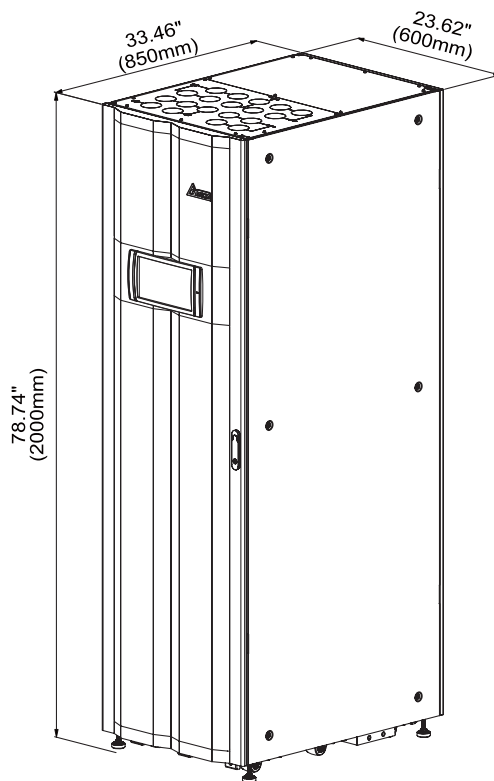

(Figure 2-1: Exterior & Dimensions)

2.5 Front View

On the front of the UPS, there are a 10" color touch panel, a tri-color LED indicator, a door switch, six casters and four leveling feet. Please see **Figure 2-2**.

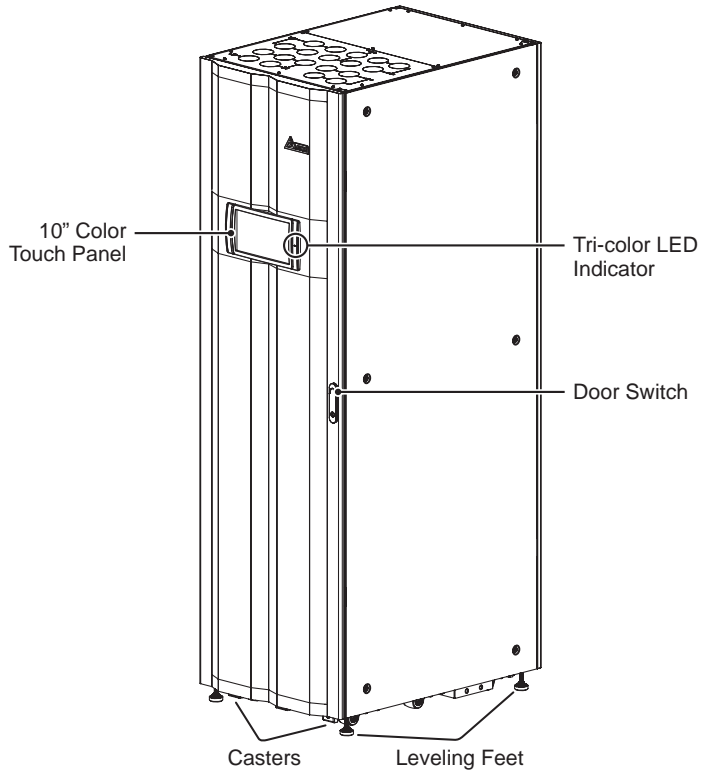

(Figure 2-2: UPS Front View)

1. For information about the 10" color touch panel, please refer to **7. LCD Display & Settings**.
2. For information about the tri-color LED indicator, please refer to **2.7 Tri-color LED Indicator & Buzzer**.
3. The casters at the bottom of the UPS can be used to move over short distances, and the leveling feet fix and stabilize the UPS on the ground. Please refer to **5.3 UPS Transportation** for relevant information.
4. Please refer to **Figure 2-3** for how to open the UPS front door.

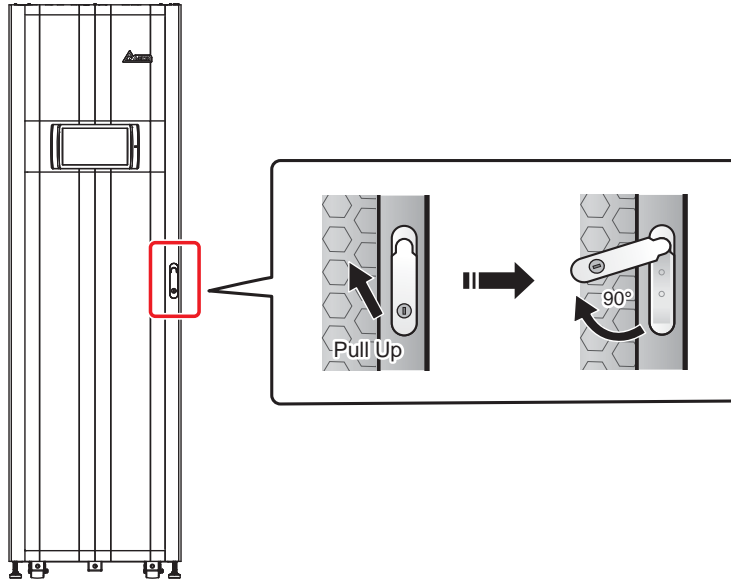

(Figure 2-3: How to Open the UPS Front Door)

2.6 Internal View



WARNING:

Only authorized Delta engineers or service personnel can perform installation, wiring, panel & cover removal, maintenance and operation. If you want to execute any action mentioned above by yourself, the action must be under the supervision of authorized Delta engineers or service personnel.

After you open the UPS's front door, you will see the internal mechanisms including communication interfaces, eight power module slots, an STS module and three breakers (Input/ Bypass/ Output). Please refer to **Figure 2-4**.

**Internal View
(Front View with Door Open)**

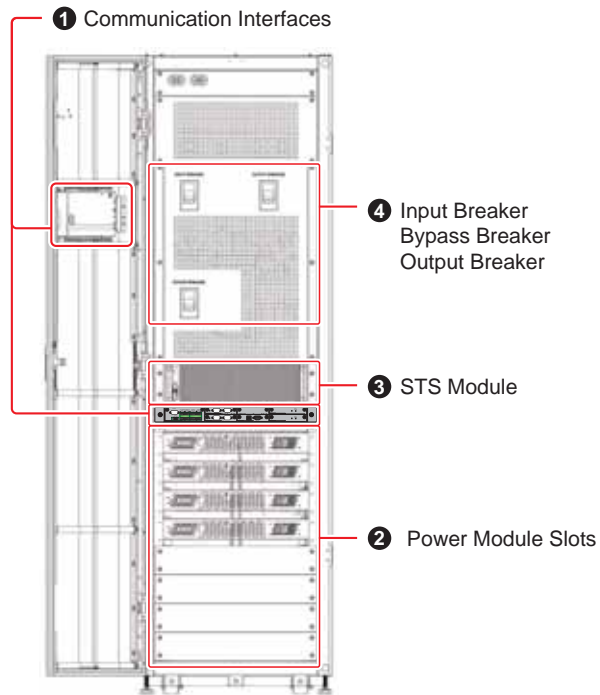

(Figure 2-4: UPS Internal View (Front View with Door Open))

No.	Description
①	The communication interfaces are located at two areas, (1) on the front of the UPS with front door open and (2) at the rear of the touch panel. For relevant information, please refer to 4. Communication Interfaces .
②	There are eight power module slots. Please follow on-site requirements to install the correct number of power modules (optional). Please refer to 5.8 Power Module (Optional) for relevant information.
③	There is one STS module. For the STS module information, please refer to 5.7 STS Module .

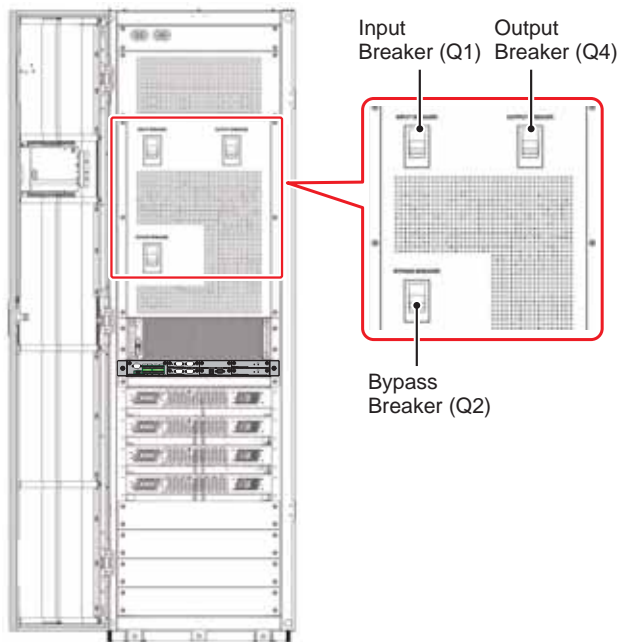
No.	Description
4	<p>The UPS has three breakers, which are Input Breaker (Q1), Bypass Breaker (Q2) and Output Breaker (Q4). Please refer to Figure 2-5 for the location of the three breakers.</p> <p style="text-align: center;">Internal View (Front View with Door Open)</p>  <p style="text-align: center;"><i>(Figure 2-5: Location of the Three Breakers)</i></p>

Please remove the wiring terminal cover (there are a total of four screws (see **Figure 2-6**) to see the wiring terminals shown in **Figure 2-7 ~ Figure 2-9**.

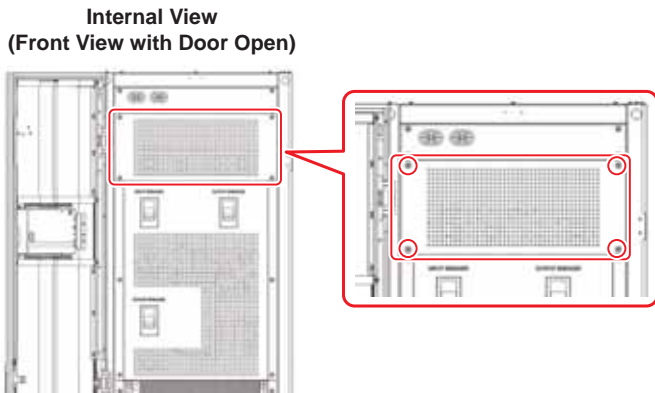

(Figure 2-6: Screw Location)

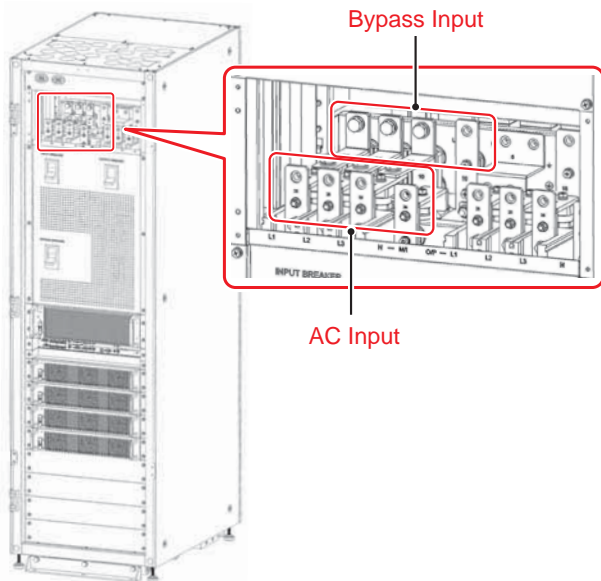

(Figure 2-7: Wiring Terminals_ AC Input & Bypass Input)

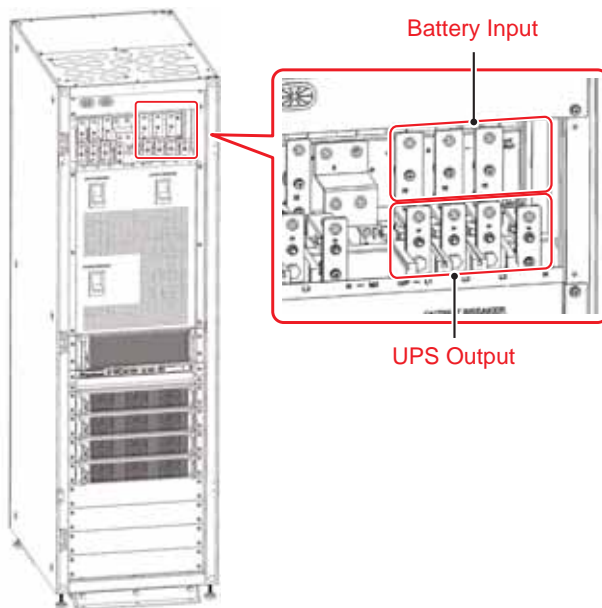

(Figure 2-8: Wiring Terminals_ UPS Output & Battery Input)

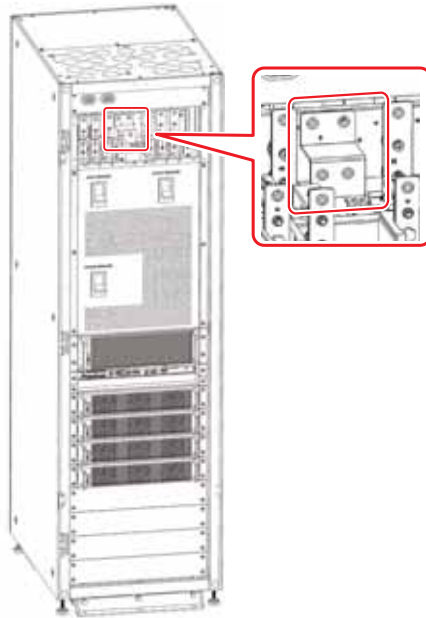

(Figure 2-9: Wiring Terminals_ Grounding)

2.7 Tri-color LED Indicator & Buzzer

Please see **Figure 2-10** for the location of the tri-color LED indicator. For information about the tri-color LED indicator, please refer to **Table 2-1**. For information about the 10" color touch panel, please refer to **7. LCD Display & Settings**.

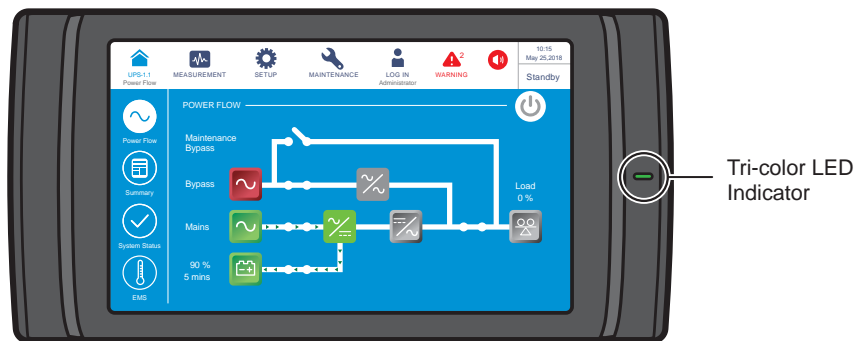

(Figure 2-10: Tri-color LED Indicator Location)

Open the UPS's front door and find the buzzer at the rear of the touch panel. Please see **Figure 2-11**.

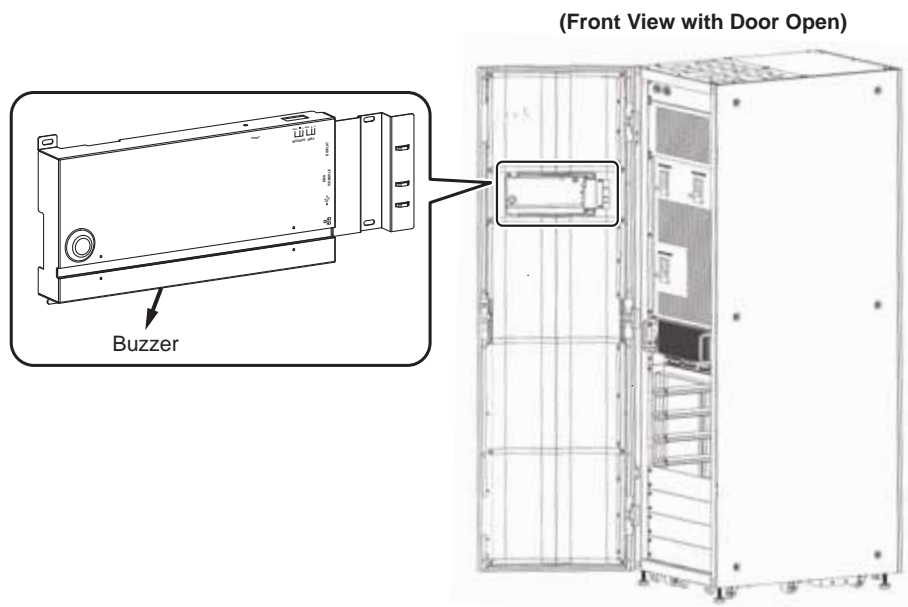

(Figure 2-11: Buzzer Location)

Table 2-1 outlines the status of the tri-color LED indicator, UPS operation mode, and buzzer.

Table 2-1: Tri-color LED Indicator, UPS Operation Mode & Buzzer

Tri-color LED Indicator	Status	Meaning										
Green	ON	<ul style="list-style-type: none"> Indicates the UPS's current operation mode; for its corresponding text shown in the upper right corner of the LCD screen, please refer to the following table. <table border="1" style="margin-left: 20px;"> <thead> <tr> <th>UPS Operation Mode</th> <th>Text on the LCD Screen (upper-right corner)</th> </tr> </thead> <tbody> <tr> <td>Online Mode</td> <td>'On-Line'</td> </tr> <tr> <td>ECO Mode</td> <td>'ECO'</td> </tr> <tr> <td>Frequency Conversion Mode</td> <td>'Frequency Conversion'</td> </tr> <tr> <td>Green Mode</td> <td>'Green'</td> </tr> </tbody> </table>	UPS Operation Mode	Text on the LCD Screen (upper-right corner)	Online Mode	'On-Line'	ECO Mode	'ECO'	Frequency Conversion Mode	'Frequency Conversion'	Green Mode	'Green'
		UPS Operation Mode	Text on the LCD Screen (upper-right corner)									
		Online Mode	'On-Line'									
		ECO Mode	'ECO'									
		Frequency Conversion Mode	'Frequency Conversion'									
Green Mode	'Green'											

Tri-color LED Indicator	Status	Meaning																		
Yellow	ON	<ul style="list-style-type: none"> <li data-bbox="577 291 1222 388">Indicates the UPS's current operation mode; for its corresponding text shown in the upper right corner of the LCD screen, please refer to the following table. <table border="1" data-bbox="610 405 1218 755"> <thead> <tr> <th data-bbox="610 405 843 484">UPS Operation Mode</th> <th data-bbox="843 405 1218 484">Text on the LCD Screen (upper-right corner)</th> </tr> </thead> <tbody> <tr> <td data-bbox="610 484 843 531">Bypass Mode</td> <td data-bbox="843 484 1218 531">'Bypass'</td> </tr> <tr> <td data-bbox="610 531 843 577">Battery Mode</td> <td data-bbox="843 531 1218 577">'Battery'</td> </tr> <tr> <td data-bbox="610 577 843 624">Standby Mode</td> <td data-bbox="843 577 1218 624">'Standby'</td> </tr> <tr> <td data-bbox="610 624 843 670">Softstart Mode</td> <td data-bbox="843 624 1218 670">'Softstart'</td> </tr> <tr> <td data-bbox="610 670 843 755">Energy Recycle Mode</td> <td data-bbox="843 670 1218 755">'Energy Recycle'</td> </tr> </tbody> </table> <ul style="list-style-type: none"> <li data-bbox="577 782 1222 840">Indicates a minor or medium warning, accompanied with buzzer sound. <table border="1" data-bbox="610 859 1218 981"> <thead> <tr> <th data-bbox="610 859 843 898">Warning Level</th> <th data-bbox="843 859 1218 898">Buzzer Frequency</th> </tr> </thead> <tbody> <tr> <td data-bbox="610 898 843 937">Minor</td> <td data-bbox="843 898 1218 937">Sounds 50ms every 3 seconds.</td> </tr> <tr> <td data-bbox="610 937 843 981">Medium</td> <td data-bbox="843 937 1218 981">Sounds 50ms every second.</td> </tr> </tbody> </table> <p data-bbox="577 1010 1222 1039">To clear the warning, please refer to 10. Troubleshooting.</p>	UPS Operation Mode	Text on the LCD Screen (upper-right corner)	Bypass Mode	'Bypass'	Battery Mode	'Battery'	Standby Mode	'Standby'	Softstart Mode	'Softstart'	Energy Recycle Mode	'Energy Recycle'	Warning Level	Buzzer Frequency	Minor	Sounds 50ms every 3 seconds.	Medium	Sounds 50ms every second.
UPS Operation Mode	Text on the LCD Screen (upper-right corner)																			
Bypass Mode	'Bypass'																			
Battery Mode	'Battery'																			
Standby Mode	'Standby'																			
Softstart Mode	'Softstart'																			
Energy Recycle Mode	'Energy Recycle'																			
Warning Level	Buzzer Frequency																			
Minor	Sounds 50ms every 3 seconds.																			
Medium	Sounds 50ms every second.																			
Red	ON	<ul style="list-style-type: none"> <li data-bbox="577 1070 1222 1128">Indicates a major warning, accompanied with buzzer sound. <table border="1" data-bbox="598 1147 1211 1230"> <thead> <tr> <th data-bbox="598 1147 847 1186">Warning Level</th> <th data-bbox="847 1147 1211 1186">Buzzer Frequency</th> </tr> </thead> <tbody> <tr> <td data-bbox="598 1186 847 1230">Major</td> <td data-bbox="847 1186 1211 1230">Long beep</td> </tr> </tbody> </table> <p data-bbox="577 1251 1222 1280">To clear the warning, please refer to 10. Troubleshooting.</p>	Warning Level	Buzzer Frequency	Major	Long beep														
Warning Level	Buzzer Frequency																			
Major	Long beep																			

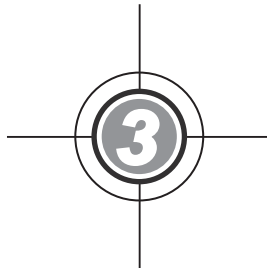

Operation Modes

3.1 Single Input

3.2 Dual Input

3.3 Hot Standby Redundancy
(Only For Dual Input & At
Least Two UPSs)

3.4 Common Battery (Only for
Parallel UPSs connecting to
the Same External Battery
Cabinet(s))

The UPS runs in eight basic operation modes, which are On-Line mode, Battery mode, Bypass mode, Manual Bypass mode, ECO mode, Frequency Conversion mode, Green mode and Energy Recycle mode. Besides these eight operation modes, the UPS is also designed for common battery application and hot standby redundancy. Please see the following sections for relevant information.



NOTE:

1. In this user manual, the meaning of Q1, Q2, Q3, Q4 and Q5 represents the following.

Code	Meaning
Q1	Input Breaker
Q2	Bypass Breaker
Q3	External Manual Bypass Breaker
Q4	Output Breaker
Q5	External Battery Cabinet's Breaker

2. Up to four UPS units can be paralleled for redundancy and capacity expansion. Only UPSs with the same capacity, voltage, frequency, version and serial No. can be paralleled. For version and serial No. information, please refer to **7.11.7 Version & S/N**. Please only use the provided parallel cable to parallel the UPS units. Otherwise, parallel functions will fail.

3.1 Single Input

3.1.1 On-Line Mode_ Single Input_ Single Unit

In On-Line mode, the main AC source supplies AC power via the Input Breaker (Q1) to the rectifier, and the rectifier converts the AC power to DC power and supplies the DC power to the inverter. In the meantime, the rectifier provides charging power to the batteries. After receiving the DC power, the inverter converts it into clean and stable AC power to the connected critical loads via the Output Breaker (Q4). Please refer to **Figure 3-1**. During On-Line mode, the UPS's tri-color LED illuminates green and the text '**On-Line**' appears in the upper right corner of the screen.

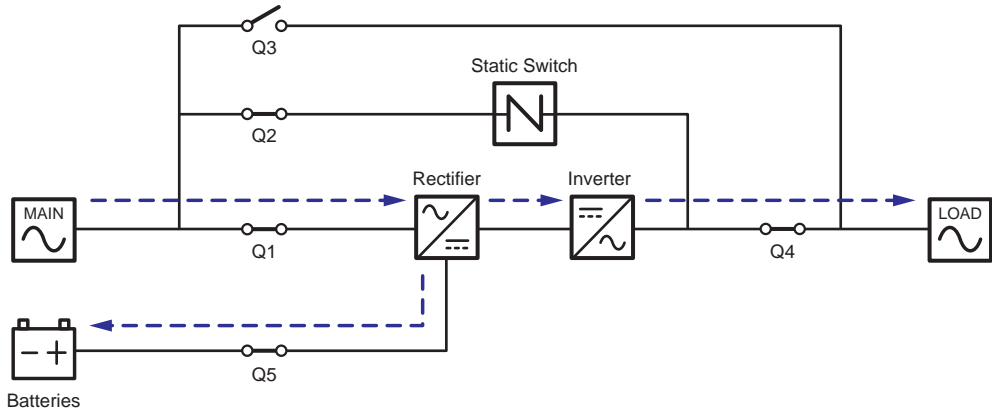

(Figure 3-1: On-Line Mode Diagram_ Single Input Single Unit)

3.1.2 Battery Mode_ Single Input Single Unit

The UPS transfers to Battery mode automatically if the main AC source is abnormal, for example, when unstable voltage or a power outage occurs. In Battery mode, the batteries provide DC power and the UPS converts it into AC power and supplies it to the connected critical loads via the Output Breaker (Q4). During the conversion process, output voltage remains the same. Please see **Figure 3-2** for Battery mode diagram. During Battery mode, the UPS's tri-color LED illuminates yellow and the text 'Battery' appears in the upper right corner of the screen.

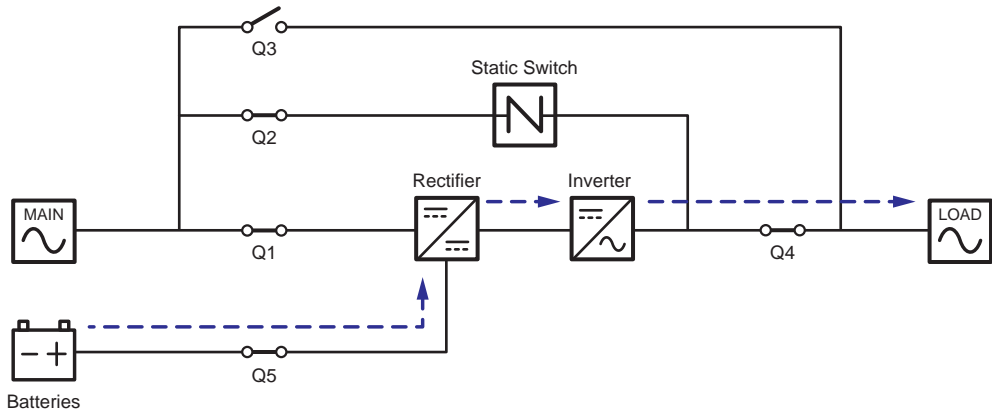

(Figure 3-2: Battery Mode Diagram_ Single Input Single Unit)

3.1.3 Bypass Mode_ Single Input_ Single Unit

When the inverter encounters abnormal situations such as over temperature, overload, short circuit, abnormal output voltage or low battery, it will automatically shut itself down. If the UPS detects the bypass AC source is normal, it will automatically switch to Bypass mode to protect the connected critical loads from power interruption. Please refer to **Figure 3-3**. After the above-mentioned abnormalities are eliminated, the UPS will switch back to On-Line mode from Bypass mode. During Bypass mode, the UPS's tri-color LED illuminates yellow and the text 'Bypass' appears in the upper right corner of the screen.

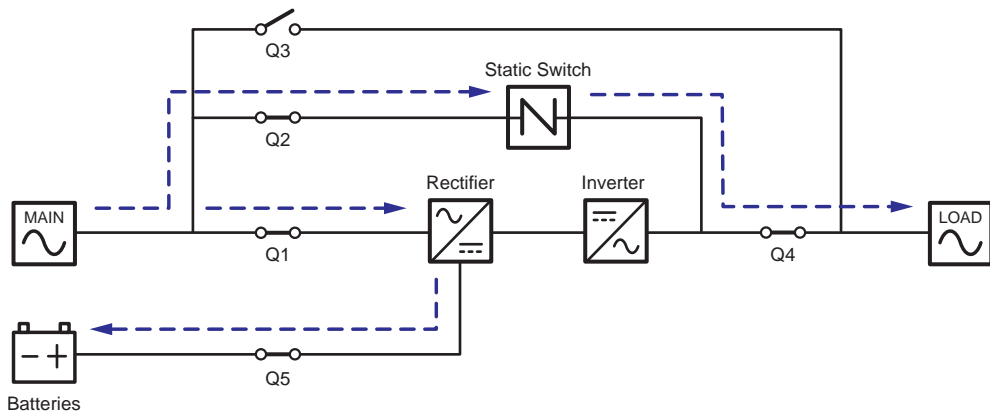

(Figure 3-3: Bypass Mode Diagram_ Single Input Single Unit)

3.1.4 Manual Bypass Mode_ Single Input_ Single Unit



WARNING:

1. In Manual Bypass mode, make sure that all of the breakers (except the External Manual Bypass Breaker (Q3)) are in the **OFF** position before working on the UPS's internal circuits. This avoids electric shock.
2. After the power inside the UPS is completely cut off, there is no high voltage inside the UPS and maintenance can be performed safely. However, to avoid electric shock, please do not touch the following parts: AC Input terminal block, Bypass Input terminal block, UPS Output terminal block, Battery Input terminal block, grounding terminals (see **Figure 2-7 ~ Figure 2-9** for the location of these terminal blocks and terminals) and any copper bars connected to the External Manual Bypass Breaker (Q3), as they may carry high voltage.
3. During Manual Bypass mode, the UPS's input power is completely cut off and the connected critical loads are not protected.
4. If the UPS connects with the External Manual Bypass Breaker (Q3), it is mandatory to interlock the breaker (Q3) electronically with the UPS to prevent accidental operation of the breaker (Q3). To interlock the breaker (Q3) with the UPS, please use the UPS's dry contacts (S4) mentioned in **4.1.4 External Switch/ Breaker Status Dry Contacts** to detect the ON/ OFF position of the breaker (Q3) through the breaker's auxiliary switch.

When the UPS needs maintenance, you can manually switch the UPS to Manual Bypass mode. To let the UPS run in Manual Bypass mode, please follow the procedures below:

- 1) Confirm that the bypass AC source and the STS module are normal.
- 2) Tap the LCD's ON/ OFF Button () and the 'POWER OFF?' screen will pop up to ask if you want to power off the UPS's inverter. Please select 'YES'.
- 3) Turn **ON** the External Manual Bypass Breaker (Q3).
- 4) Turn **OFF** the Bypass Breaker (Q2).
- 5) Turn **OFF** the Input Breaker (Q1) and Output Breaker (Q4).
- 6) Turn **OFF** each external battery cabinet's breaker (Q5).

In Manual Bypass mode, all power inside the UPS is completely cut off and maintenance personnel can perform maintenance safely. Please see **Figure 3-4** for Manual Bypass mode diagram. During Manual Bypass mode, the UPS's tri-color LED and LCD are both off.

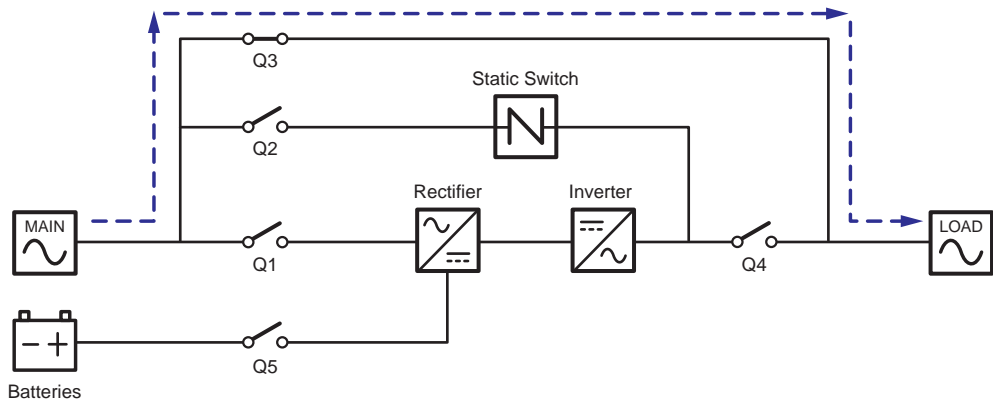

(Figure 3-4: Manual Bypass Mode Diagram_ Single Input Single Unit)

3.1.5 ECO Mode_ Single Input_ Single Unit

To activate ECO mode, please refer to **6.2.5 ECO Mode Start-up Procedures**, **7.6 Main Screen** and **7.10.2 Mode Setting**.

In ECO mode, when bypass AC source's input voltage and frequency are within the range of rating voltage $\pm 10\%$ and rating frequency $\pm 3\text{Hz}$, the UPS works in Bypass mode; otherwise, the UPS runs in On-Line mode. For ECO mode diagram, please see **Figure 3-5**. During ECO mode, the UPS's tri-color LED illuminates green and the text 'ECO' appears in the upper right corner of the screen.

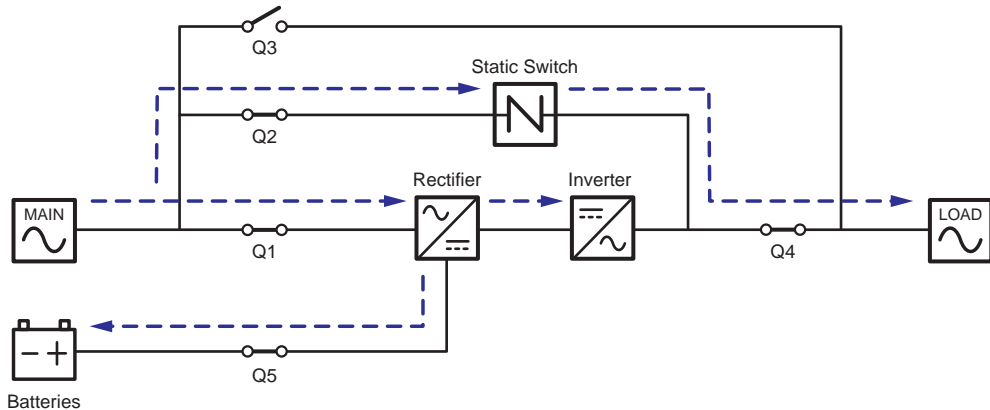

(Figure 3-5: ECO Mode Diagram_ Single Input Single Unit)

3.1.6 Frequency Conversion Mode_ Single Input_ Single Unit



NOTE:

1. Frequency Conversion mode is only applicable to single UPS but not to parallel UPSs.
2. When the UPS runs in Frequency Conversion mode, once the inverter becomes off, there is no bypass power supplying to the loads.

To activate Frequency Conversion mode, please refer to **6.2.6 Frequency Conversion Mode Start-up Procedures**, **7.6 Main Screen** and **7.10.2 Mode Setting**.

After the UPS is manually set in Frequency Conversion mode, the inverter will automatically select 50Hz or 60Hz as the fixed output frequency. After the output frequency is determined, the system will automatically disable the bypass function. Please note that, once the inverter shuts down, there is no bypass output. For the diagram of Frequency Conversion mode, please see **Figure 3-6**. During Frequency Conversion mode, the UPS's tri-color LED illuminates green and the text '**Frequency Conversion**' appears in the upper right corner of the screen.

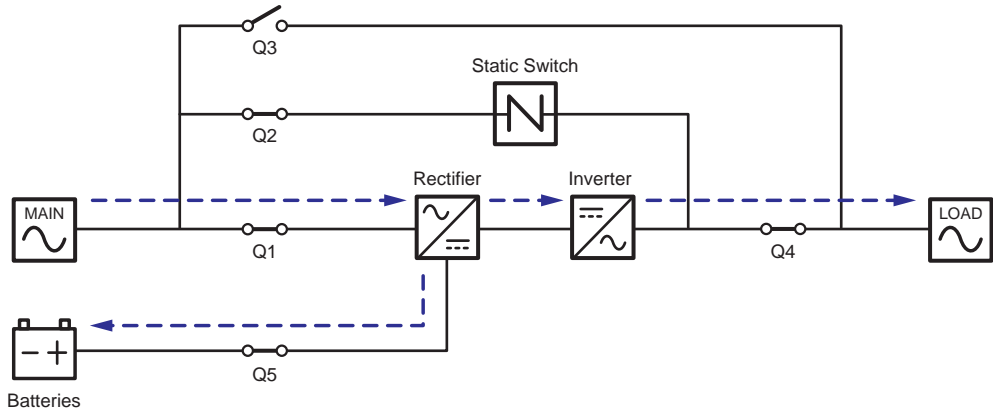

(Figure 3-6: Frequency Conversion Mode Diagram_ Single Input Single Unit)

3.1.7 Green Mode_ Single Input_ Single Unit



NOTE:

Green mode is only applicable to single UPS but not to parallel UPSs.

To activate Green mode, please refer to **6.2.7 Green Mode Start-up Procedures**, **7.6 Main Screen** and **7.10.2 Mode Setting**.

Green mode is the same as On-Line mode, but the difference is that the system will automatically detect the output status (i.e. total load capacity %) to decide which specific power modules should be fully powered on or idle in order to achieve higher efficiency of the UPS. For the Green mode diagram, please see **Figure 3-7**. During Green mode, the UPS's tri-color LED illuminates green and the text 'Green' appears in the upper right corner of the screen.

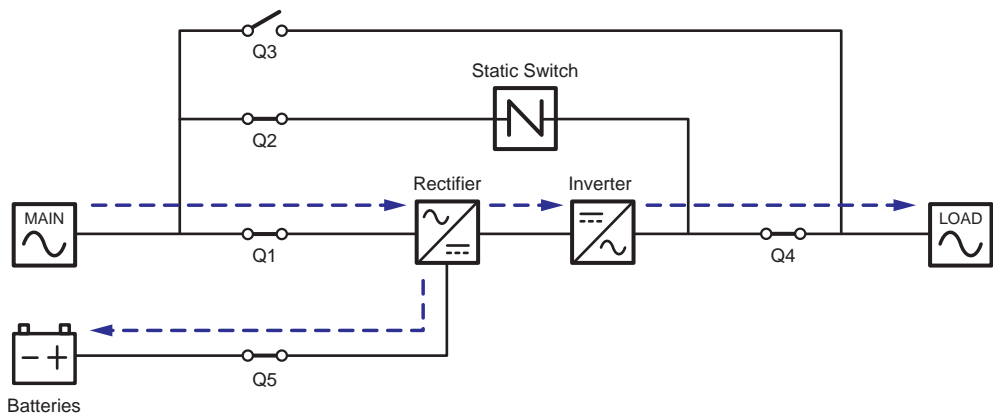

(Figure 3-7: Green Mode Diagram_ Single Input Single Unit)

3.1.8 Energy Recycle Mode_ Single Input_ Single Unit



NOTE:

1. Energy Recycle mode is only applicable to single input and single unit application.
2. Do not let the UPS run in Energy Recycle mode when batteries are supplying power to the loads.
3. Only qualified personnel can perform the following operations.

Energy Recycle mode is only applicable to UPS self-test only. Without connection to any critical loads, the UPS can execute current test under full load condition. Before you activate Energy Recycle mode, please make sure that the External Manual Bypass Breaker (Q3), Output Breaker (Q4) and each external battery cabinet's battery breaker (Q5) are in the **OFF** status.

To activate Energy Recycle mode, please refer to **6.2.8 Energy Recycle Mode Start-up Procedures**, **7.6 Main Screen** and **7.10.2 Mode Setting**.

For the diagram of Energy Recycle mode, please see **Figure 3-8**. During Energy Recycle mode, the UPS's tri-color LED illuminates yellow and the text 'Energy Recycle' appears in the upper right corner of the screen.

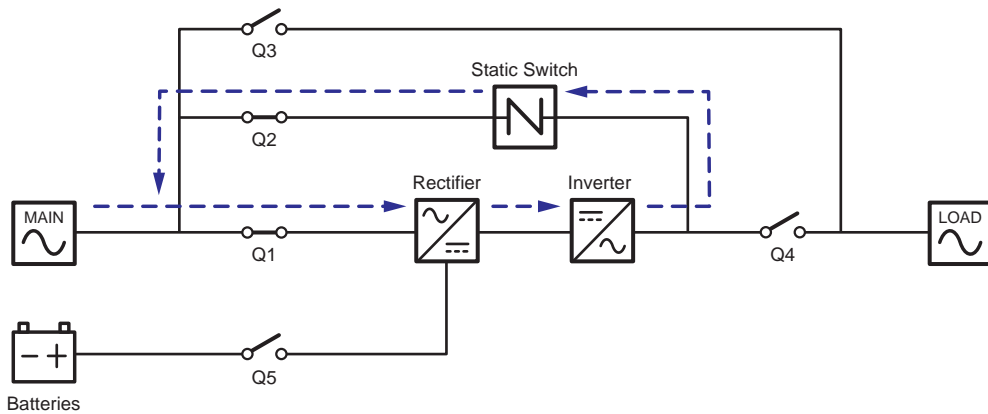

(Figure 3-8: Energy Recycle Mode Diagram_ Single Input Single Unit)

3.1.9 On-Line Mode_ Single Input_ Parallel Units

In On-Line mode (parallel), the total loads will be equally shared by parallel UPSs. If one of the parallel units fails and its load is less than the total capacity of the remaining parallel units, the failing UPS's output will be switched off and its load will be equally shared by the remaining parallel units. If the failing UPS's load is larger than the total capacity of the remaining parallel units, all UPSs' inverters will turn off and the total loads will be supplied by bypass power. During On-Line mode (parallel), each UPS's tri-color LED illuminates green and each UPS's LCD shows the text 'On-Line' in the upper right corner. Please refer to **Figure 3-9** for the path of electrical power through the parallel UPSs in On-Line mode.

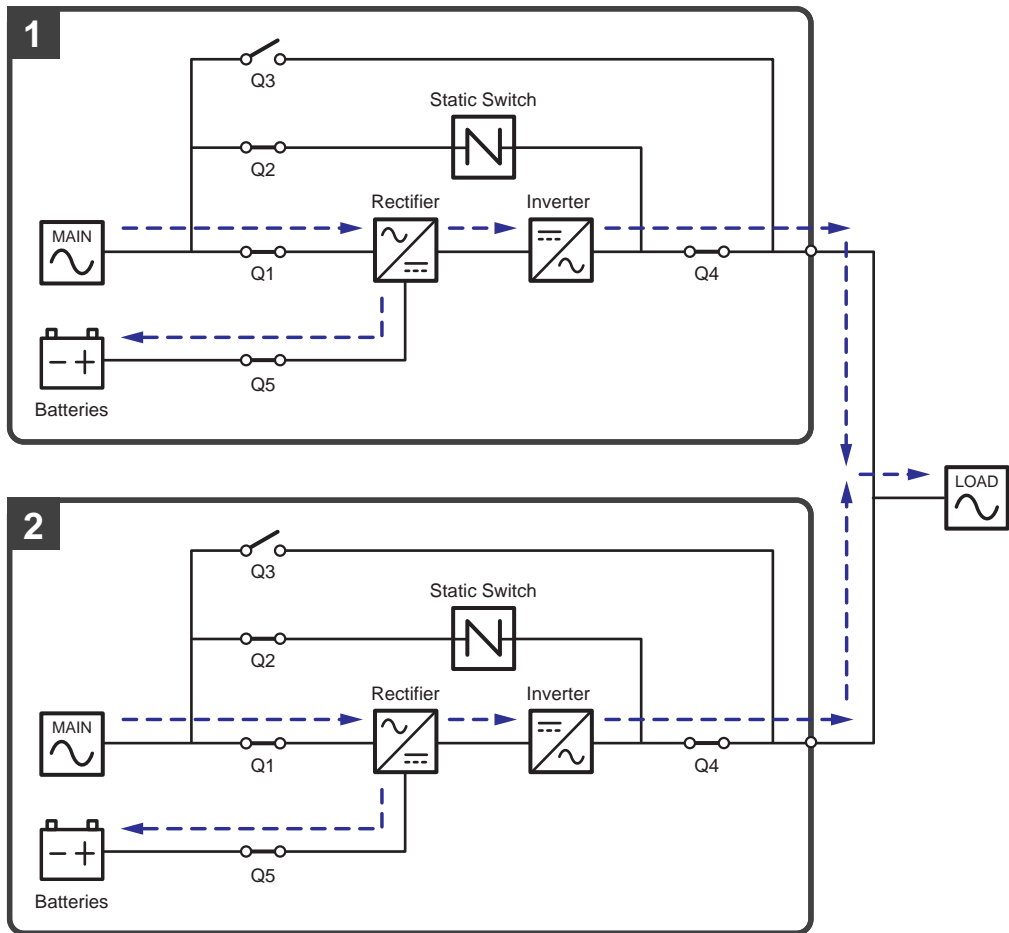

(Figure 3-9: On-Line Mode Diagram_ Single Input Parallel Units)

3.1.10 Battery Mode_ Single Input_ Parallel Units

If the main AC source is abnormal, for example, when unstable voltage or a power outage occurs, all parallel UPSs will automatically transfer from On-Line mode to Battery mode. During the conversion process, output voltage remains the same, and during Battery mode (parallel), each UPS's tri-color LED illuminates yellow and each UPS's LCD shows the text 'Battery' in the upper right corner. Please refer to **Figure 3-10** for the path of electrical power through the parallel UPSs in Battery mode.

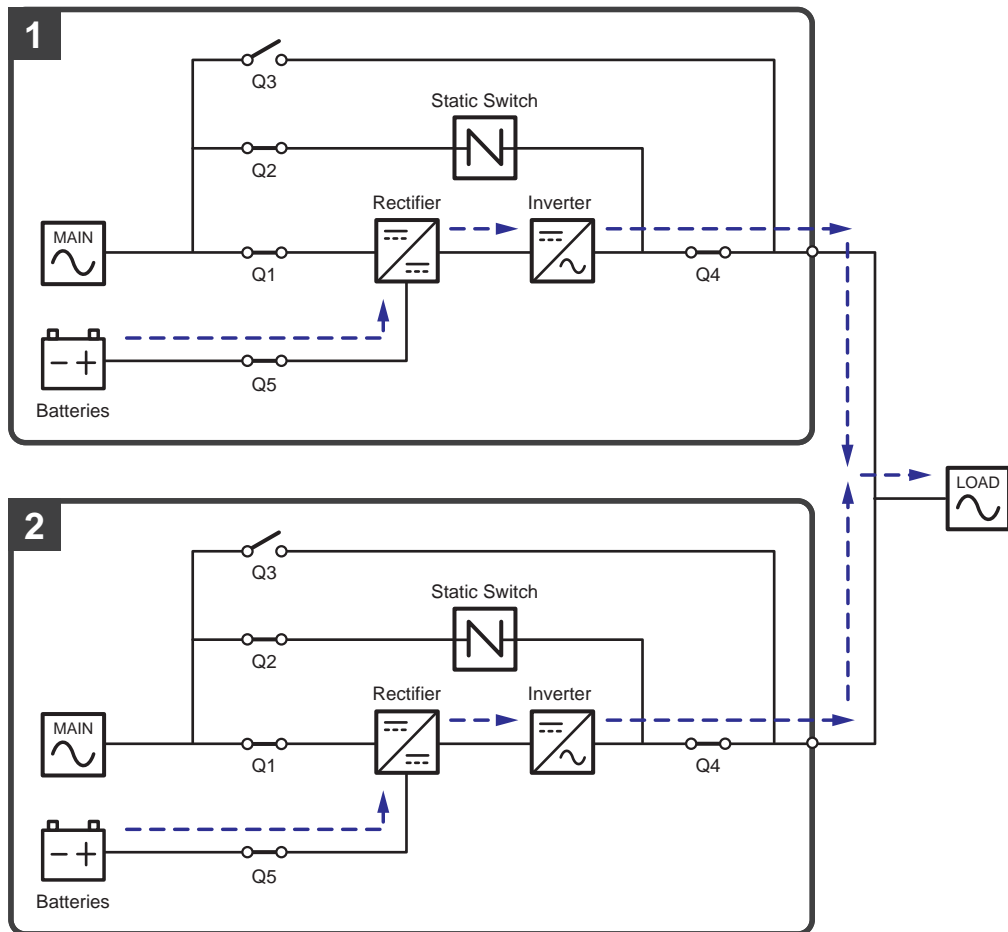

(Figure 3-10: Battery Mode Diagram_ Single Input Parallel Units)

3.1.11 Bypass Mode_ Single Input_ Parallel Units

In Bypass mode (parallel), when all inverters encounter abnormal situations such as overload, short circuit, abnormal output voltage or low battery, they will automatically shut themselves down. Meanwhile, if all parallel UPSs detect the bypass AC source is normal, they will automatically switch to Bypass mode to protect the connected critical loads from power interruption. The critical loads will be equally shared by all parallel units. After the abnormalities mentioned above are eliminated, the parallel UPSs will switch back to On-Line mode from Bypass mode. During Bypass mode (parallel), each UPS's tri-color LED illuminates yellow and each UPS's LCD shows the text 'Bypass' in the upper right corner. Please refer to **Figure 3-11** for the path of electrical power through the parallel UPSs in Bypass mode.

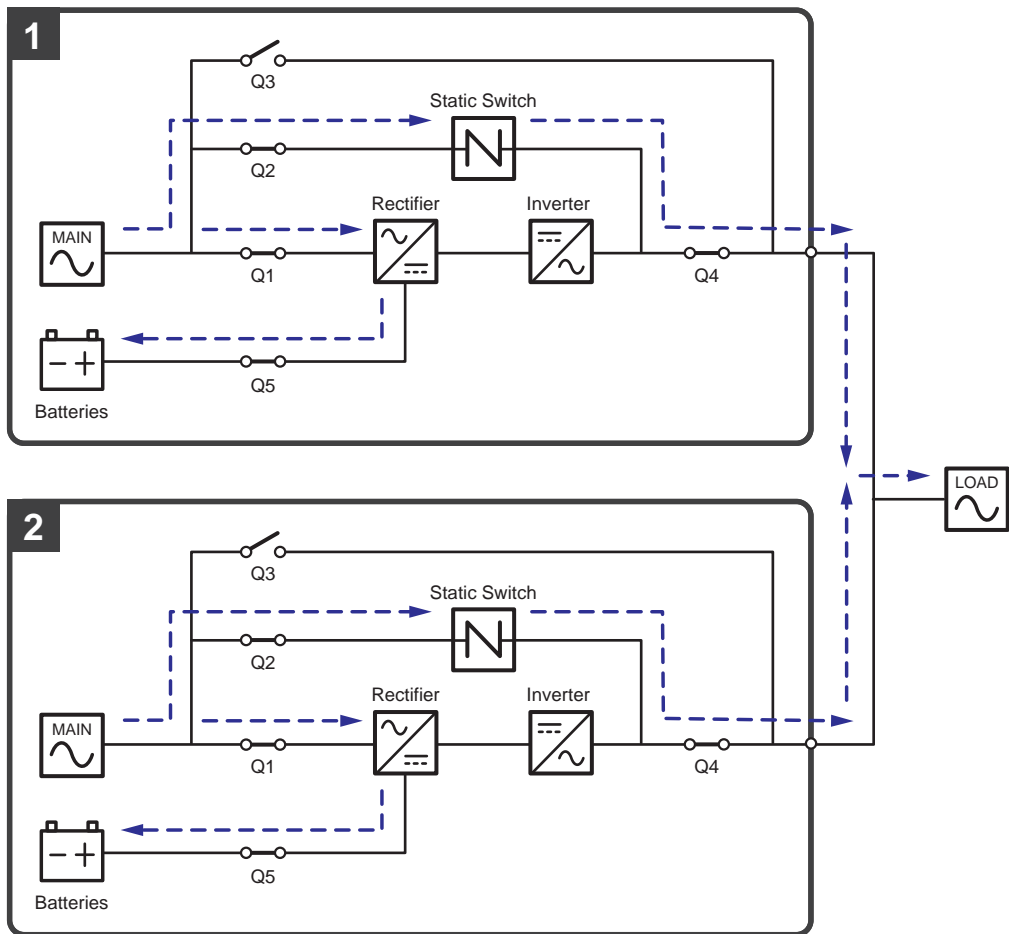

(Figure 3-11: Bypass Mode Diagram_ Single Input Parallel Units)

3.1.12 Manual Bypass Mode_ Single Input_ Parallel Units



WARNING:

1. In Manual Bypass mode, make sure that all of the breakers (except each External Manual Bypass Breaker (Q3)) are in the **OFF** position before working on any of the parallel UPSs' internal circuits. This avoids electric shock.
2. After the power inside each of the parallel UPSs is completely cut off, there is no high voltage inside all parallel UPSs and maintenance can be performed safely. However, to avoid electric shock, please do not touch the following parts on each parallel UPS: AC Input terminal block, Bypass Input terminal block, UPS Output terminal block, Battery Input terminal block, grounding terminals (see **Figure 2-7 ~ Figure 2-9** for the location of these terminal blocks and terminals) and any copper bars connected to the External Manual Bypass Breaker (Q3), as they may carry high voltage.
3. During Manual Bypass mode, each parallel UPS's input power is completely cut off and the connected critical loads are not protected.
4. For parallel UPSs, if you want to turn off one of the parallel UPSs for maintenance, please make sure the total connected critical loads will not exceed the remaining parallel units' total capacity.

In Manual Bypass mode (parallel), if one of the parallel UPSs needs maintenance, please first confirm that the bypass AC source and each parallel UPS's STS module are normal. After confirmation, please follow the procedures below to manually switch each of the parallel UPSs to Manual Bypass mode.

- 1 Tap each LCD's ON/ OFF Button () and the '**POWER OFF?**' screen will pop up to ask if you want to power off the UPS's inverter. Please select '**YES**'.
- 2 Turn **ON** each UPS's External Manual Bypass Breaker (Q3).
- 3 Turn **OFF** each UPS's Bypass Breaker (Q2).
- 4 Turn **OFF** each UPS's Input Breaker (Q1) and Output Breaker (Q4).
- 5 Turn **OFF** each external battery cabinet's breaker (Q5).

In Manual Bypass mode, all power inside the parallel UPSs is completely cut off and maintenance personnel can perform maintenance safely. Power of the connected critical loads will be supplied by manual bypass. During Manual Bypass mode (parallel), all parallel UPSs' tri-color LEDs and LCDs are off. Please see **Figure 3-12** for the path of electrical power through the parallel UPSs in Manual Bypass mode.

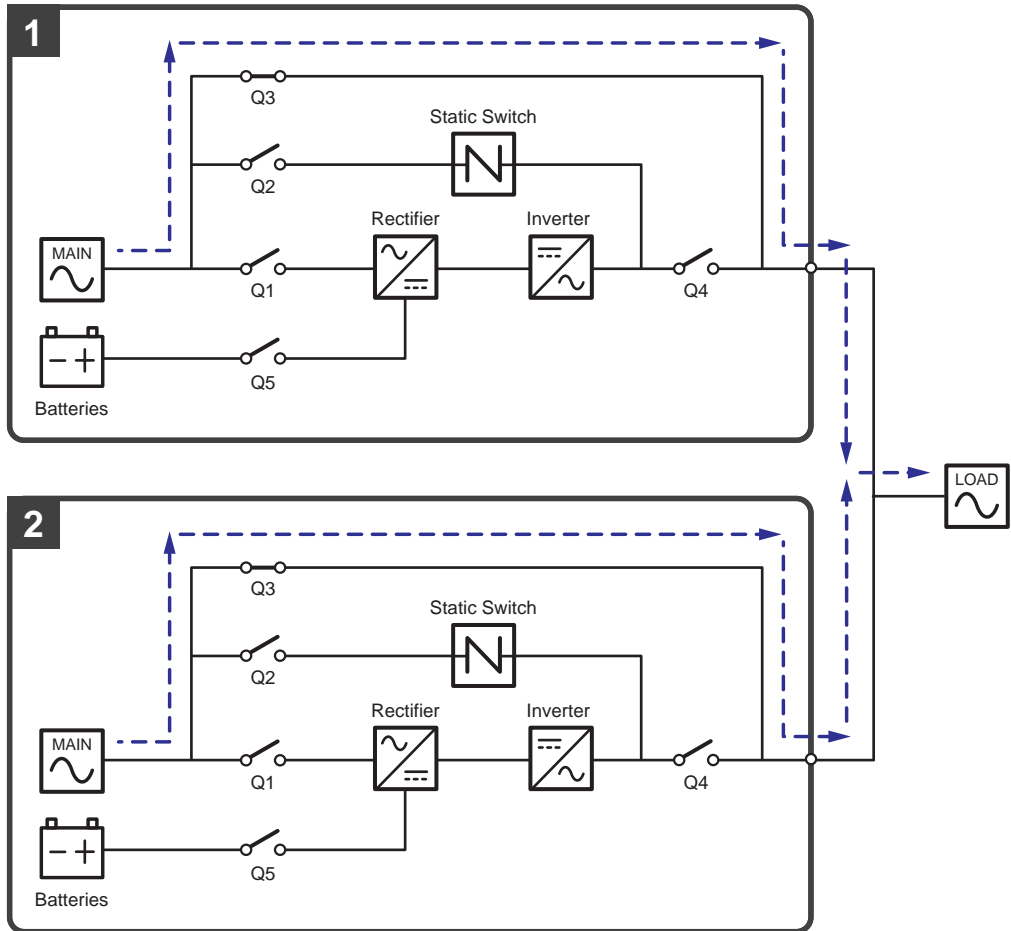

(Figure 3-12: Manual Bypass Mode Diagram_ Single Input Parallel Units)

3.1.13 ECO Mode_ Single Input_ Parallel Units

To activate ECO mode, please refer to **6.2.5 ECO Mode Start-up Procedures**, **7.6 Main Screen** and **7.10.2 Mode Setting**.

In ECO mode (parallel), when each parallel UPS's bypass input voltage and frequency are within the range of rating voltage $\pm 10\%$ and rating frequency $\pm 3\text{Hz}$, each parallel UPS works in Bypass mode; otherwise, each parallel UPS runs in On-Line mode. During ECO mode (parallel), each UPS's tri-color LED illuminates green and each UPS's LCD shows the text 'ECO' in the upper right corner. Please see **Figure 3-13** for the path of electrical power through the parallel UPSs in ECO mode.

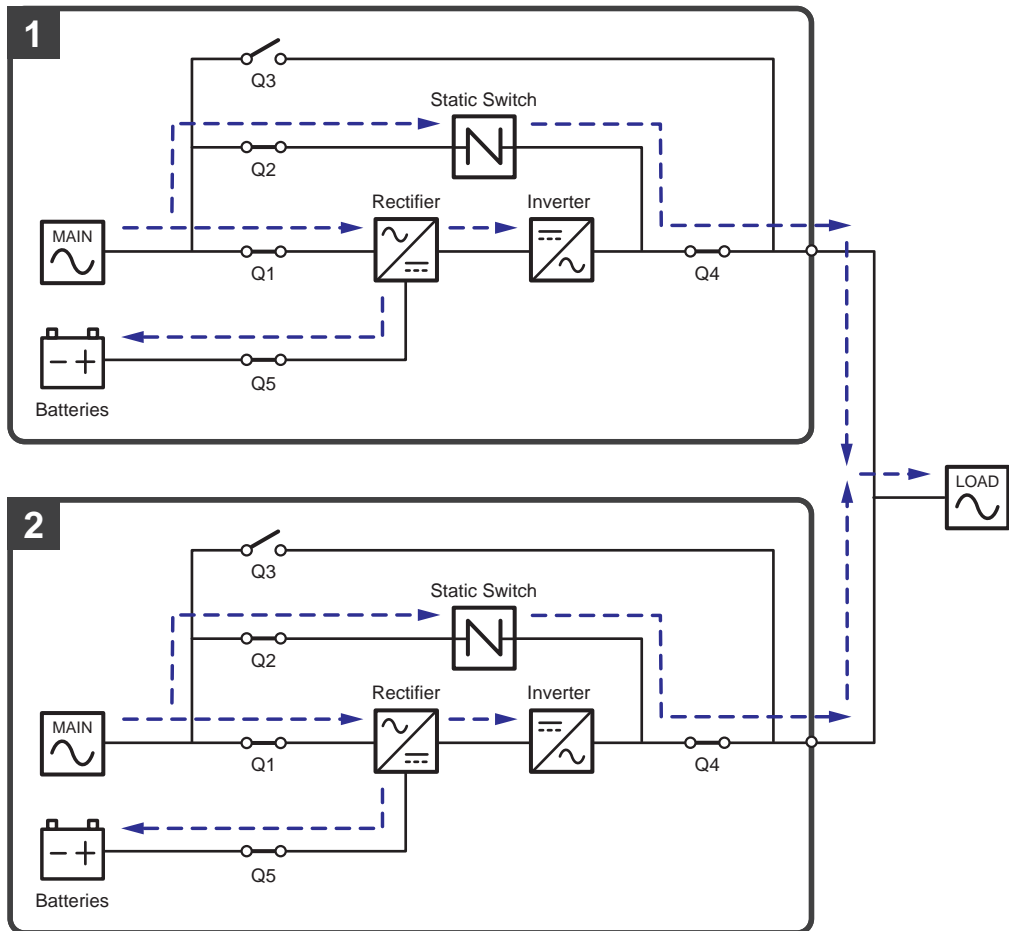

(Figure 3-13: ECO Mode Diagram_ Single Input Parallel Units)

3.2 Dual Input

3.2.1 On-Line Mode_ Dual Input_ Single Unit

In On-Line mode, the main AC source supplies AC power via the Input Breaker (Q1) to the rectifier, and the rectifier converts the AC power to DC power and supplies the DC power to the inverter. In the meantime, the rectifier provides charging power to the batteries. After receiving the DC power, the inverter converts it into clean and stable AC power to the connected critical loads via the Output Breaker (Q4). Please see **Figure 3-14** for On-Line mode diagram. During On-Line mode, the UPS's tri-color LED illuminates green and the text 'On-Line' appears in the upper right corner of the screen.

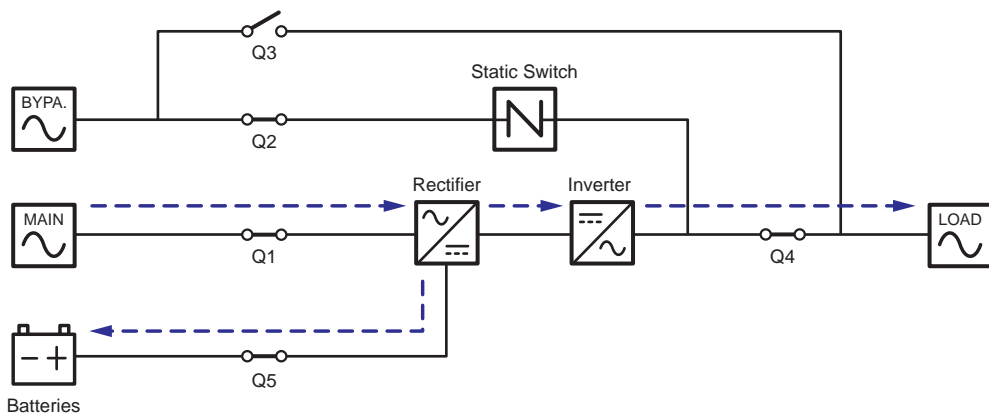

(Figure 3-14: On-Line Mode Diagram_ Dual Input Single Unit)

3.2.2 Battery Mode_ Dual Input_ Single Unit

The UPS transfers to Battery mode automatically if the main AC source is abnormal, for example, when unstable voltage or a power outage occurs. In Battery mode, the batteries provide DC power and the UPS converts it into AC power and supplies it to the connected critical loads via the Output Breaker (Q4). During the conversion process, output voltage remains the same. Please see **Figure 3-15** for Battery mode diagram. During Battery mode, the UPS's tri-color LED illuminates yellow and the text 'Battery' appears in the upper right corner of the screen.

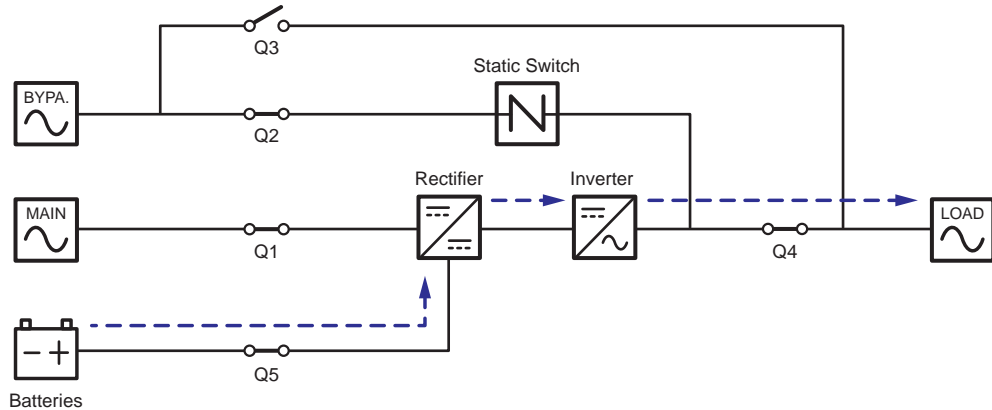

(Figure 3-15: Battery Mode Diagram_Dual Input Single Unit)

3.2.3 Bypass Mode_Dual Input_Single Unit

When the inverter encounters abnormal situations such as over temperature, overload, short circuit, abnormal output voltage or low battery, it will automatically shut itself down. If the UPS detects the bypass AC source is normal, it will automatically switch to Bypass mode to protect the connected critical loads from power interruption. Please refer to **Figure 3-16**. After the above-mentioned abnormalities are eliminated, the UPS will switch back to On-Line mode from Bypass mode. During Bypass mode, the UPS's tri-color LED illuminates yellow and the text 'Bypass' appears in the upper right corner of the screen.

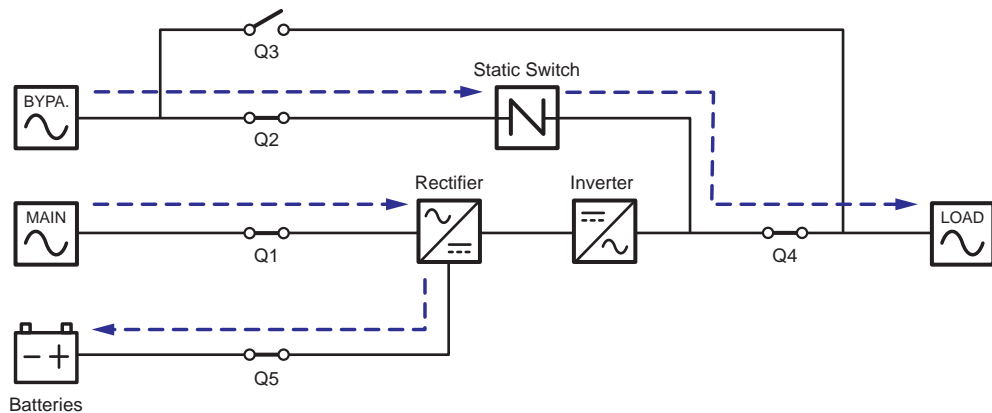

(Figure 3-16: Bypass Mode Diagram_Dual Input Single Unit)

3.2.4 Manual Bypass Mode_ Dual Input_ Single Unit



WARNING:

1. In Manual Bypass mode, make sure that all of the breakers (except the External Manual Bypass Breaker (Q3)) are in the **OFF** position before working on the UPS's internal circuits. This avoids electric shock.
2. After the power inside the UPS is completely cut off, there is no high voltage inside the UPS and maintenance can be performed safely. However, to avoid electric shock, please do not touch the following parts: AC Input terminal block, Bypass Input terminal block, UPS Output terminal block, Battery Input terminal block, grounding terminals (see **Figure 2-7 ~ Figure 2-9** for the location of these terminal blocks and terminals) and any copper bars connected to the External Manual Bypass Breaker (Q3), as they may carry high voltage.
3. During Manual Bypass mode, the UPS's input power is completely cut off and the connected critical loads are not protected.
4. If the UPS connects with the External Manual Bypass Breaker (Q3), it is mandatory to interlock the breaker (Q3) electronically with the UPS to prevent accidental operation of the breaker (Q3). To interlock the breaker (Q3) with the UPS, please use the UPS's dry contacts (S4) mentioned in **4.1.4 External Switch/ Breaker Status Dry Contacts** to detect the ON/ OFF position of the breaker (Q3) through the breaker's auxiliary switch.

When the UPS needs maintenance, you can manually switch the UPS to Manual Bypass mode. To let the UPS run in Manual Bypass mode, please follow the procedures below:

- 1) Confirm that the bypass AC source and the STS module are normal.
- 2) Tap the LCD's ON/ OFF Button () and the 'POWER OFF?' screen will pop up to ask if you want to power off the UPS's inverter. Please select 'YES'.
- 3) Turn **ON** the External Manual Bypass Breaker (Q3).
- 4) Turn **OFF** the Bypass Breaker (Q2).
- 5) Turn **OFF** the Input Breaker (Q1) and Output Breaker (Q4).
- 6) Turn **OFF** each external battery cabinet's breaker (Q5).

In Manual Bypass mode, all power inside the UPS is completely cut off and maintenance personnel can perform maintenance safely. Please see **Figure 3-17** for Manual Bypass mode diagram. During Manual Bypass mode, the UPS's tri-color LED and LCD are both off.

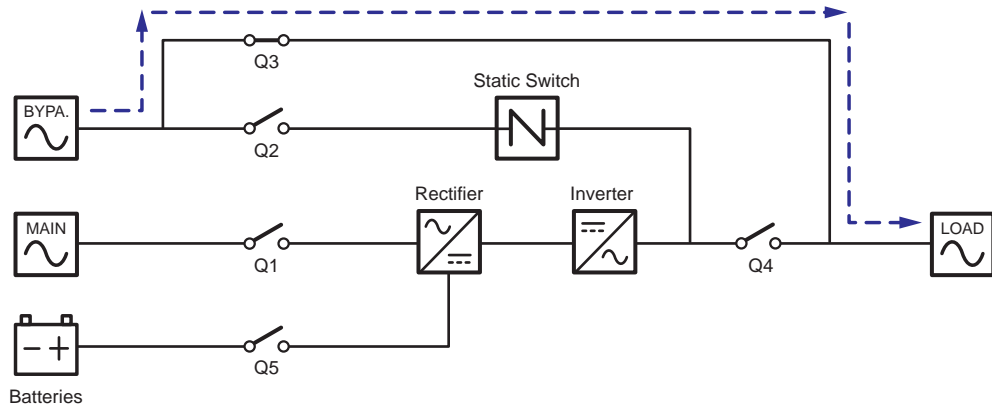

(Figure 3-17: Manual Bypass Mode Diagram_ Dual Input Single Unit)

3.2.5 ECO Mode_ Dual Input_ Single Unit

To activate ECO mode, please refer to **6.2.5 ECO Mode Start-up Procedures**, **7.6 Main Screen** and **7.10.2 Mode Setting**.

In ECO mode, when the bypass AC source's input voltage and frequency are within the range of rating voltage $\pm 10\%$ and rating frequency $\pm 3\text{Hz}$, the UPS works in Bypass mode; otherwise, the UPS runs in On-Line mode. For ECO mode diagram, please see **Figure 3-18**. During ECO mode, the UPS's tri-color LED illuminates green and the text 'ECO' appears in the upper right corner of the screen.

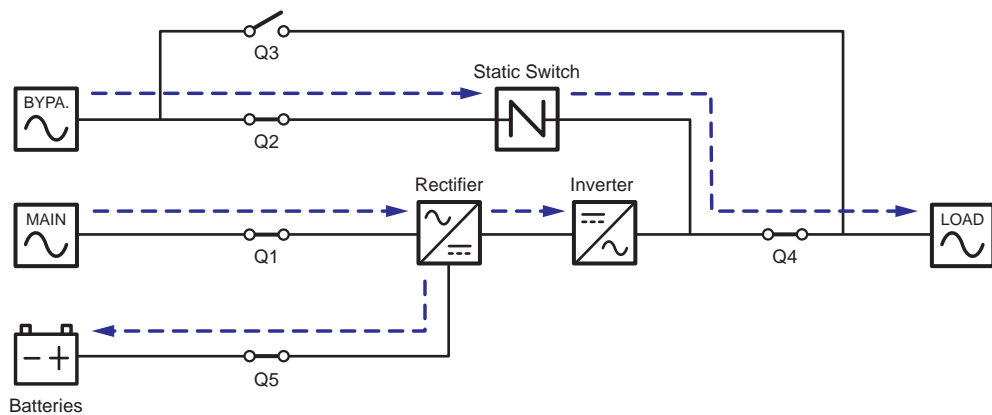

(Figure 3-18: ECO Mode Diagram_ Dual Input Single Unit)

3.2.6 Frequency Conversion Mode_ Dual Input_ Single Unit



NOTE:

1. Frequency Conversion mode is only applicable to single UPS but not to parallel UPSs.
2. When the UPS runs in Frequency Conversion mode, once the inverter becomes off, there is no bypass power supplying to the loads.

To activate Frequency Conversion mode, please refer to **6.2.6 Frequency Conversion Mode Start-up Procedures**, **7.6 Main Screen** and **7.10.2 Mode Setting**.

After the UPS is manually set in Frequency Conversion mode, the inverter will automatically select 50Hz or 60Hz as the fixed output frequency. After the output frequency is determined, the system will automatically disable the bypass function. Please note that, once the inverter shuts down, there is no bypass output. For the diagram of Frequency Conversion mode, please see **Figure 3-19**. During Frequency Conversion mode, the UPS's tri-color LED illuminates green and the text 'Frequency Conversion' appears in the upper right corner of the screen.

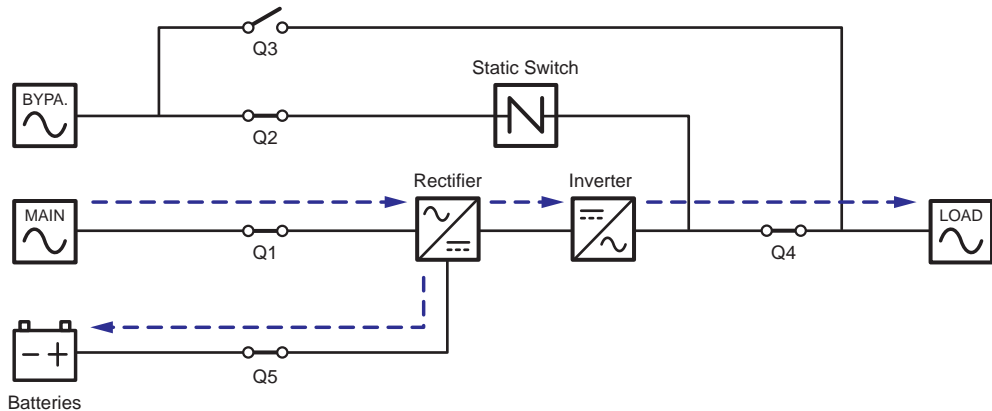

(Figure 3-19: Frequency Conversion Mode Diagram_ Dual Input Single Unit)

3.2.7 Green Mode_ Dual Input_ Single Unit



NOTE:

Green mode is only applicable to single UPS but not to parallel UPSs.

To activate Green mode, please refer to **6.2.7 Green Mode Start-up Procedures**, **7.6 Main Screen** and **7.10.2 Mode Setting**.

Green mode is the same as On-Line mode, but the difference is that the system will automatically detect the output status (i.e. total load capacity %) to decide which specific power modules should be fully powered on or idle in order to achieve higher efficiency of the UPS. For the Green mode diagram, please see **Figure 3-20**. During Green mode, the UPS's tri-color LED illuminates green and the text 'Green' appears in the upper right corner of the screen.

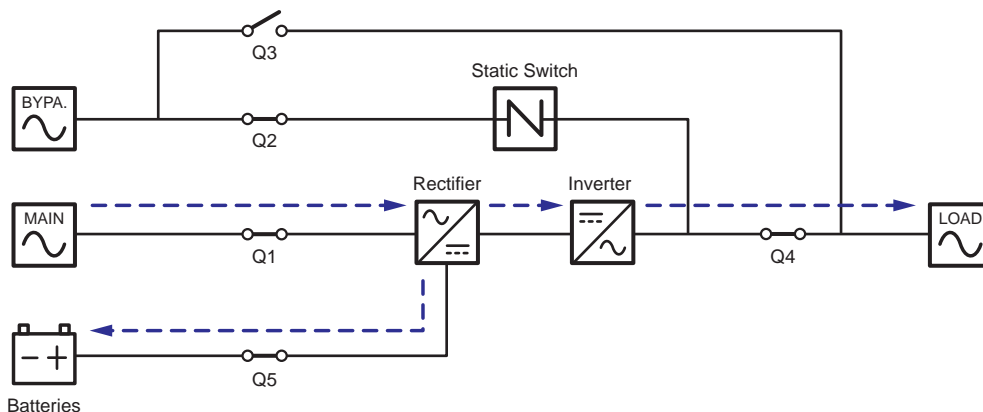

(Figure 3-20: Green Mode Diagram_ Dual Input Single Unit)

3.2.8 On-Line Mode_ Dual Input_ Parallel Units

In On-Line mode (parallel), the total loads will be equally shared by the parallel UPSs. If one of the parallel units fails and its load is less than the total capacity of the remaining parallel units, the failing UPS's output will be switched off and its load will be equally shared by the remaining parallel units. If the failing UPS's load is larger than the total capacity of the remaining parallel units, all UPSs' inverters will turn off and the total loads will be supplied by bypass power. During On-Line mode (parallel), each UPS's tri-color LED illuminates green and each UPS's LCD shows the text 'On-Line' in the upper right corner. Please refer to **Figure 3-21** for the path of electrical power through the parallel UPSs in On-Line mode.

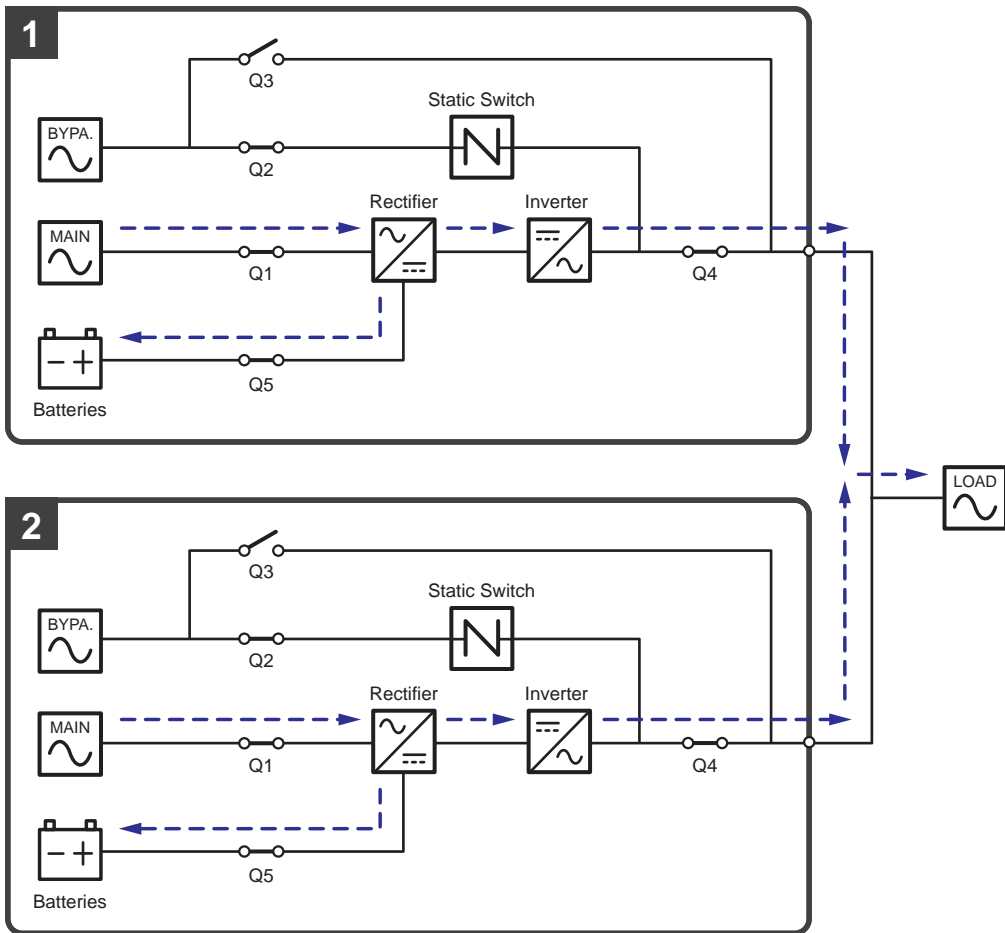

(Figure 3-21: On-Line Mode Diagram_ Dual Input Parallel Units)

3.2.9 Battery Mode_ Dual Input_ Parallel Units

If the main AC source is abnormal, for example, when unstable voltage or a power outage occurs, all parallel UPSs will automatically transfer from On-Line mode to Battery mode. During the conversion process, output voltage remains the same. During Battery mode (parallel), each UPS's tri-color LED illuminates yellow and each UPS's LCD shows the text 'Battery' in the upper right corner. Please refer to **Figure 3-22** for the path of electrical power through the parallel UPSs in Battery mode.

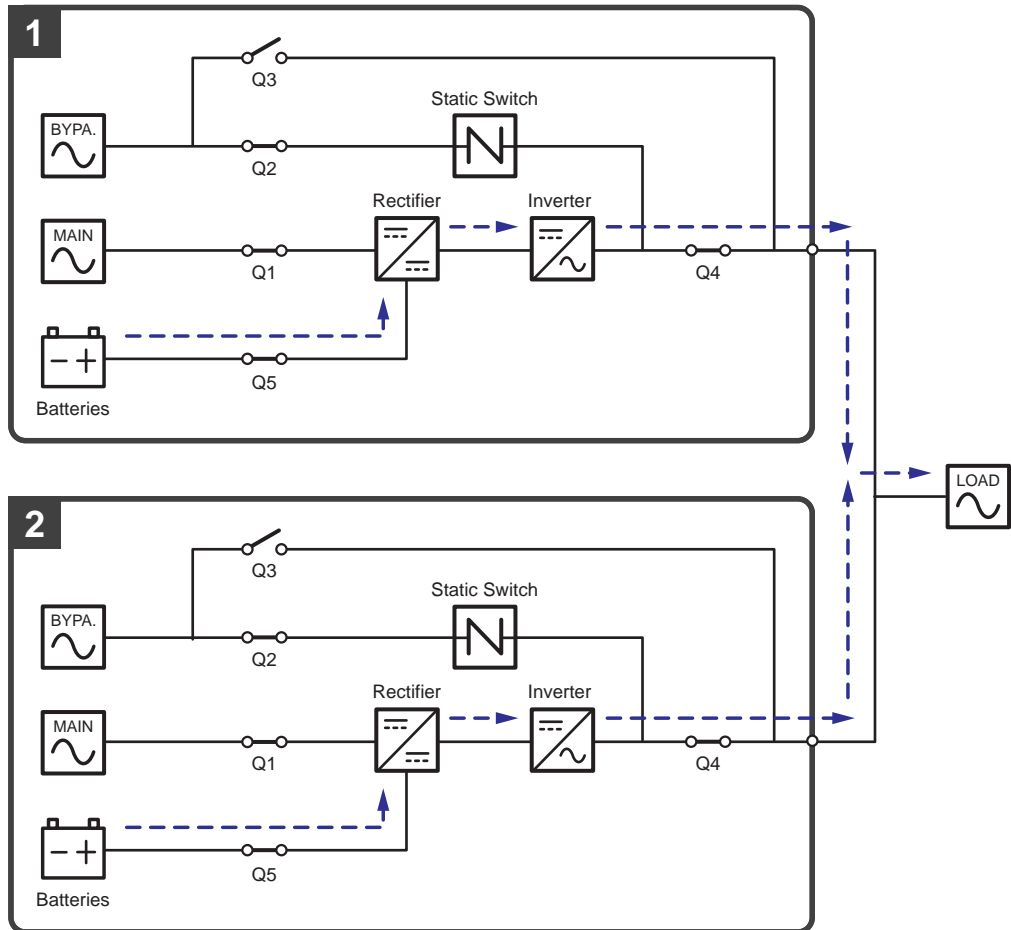

(Figure 3-22: Battery Mode Diagram_ Dual Input Parallel Units)

3.2.10 Bypass Mode_ Dual Input_ Parallel Units

In Bypass mode (parallel), when all inverters encounter abnormal situations such as overload, short circuit, abnormal output voltage or low battery, they will automatically shut themselves down. Meanwhile, if all parallel UPSs detect the bypass AC source is normal, they will automatically switch to Bypass mode to protect the connected critical loads from power interruption. The critical loads will be equally shared by all parallel units. After the abnormalities mentioned above are eliminated, the parallel UPSs will switch back to On-Line mode from Bypass mode. During Bypass mode (parallel), each UPS's tri-color LED illuminates yellow and each UPS's LCD shows the text 'Bypass' in the upper right corner. Please see **Figure 3-23** for the path of electrical power through the parallel UPSs in Bypass mode.

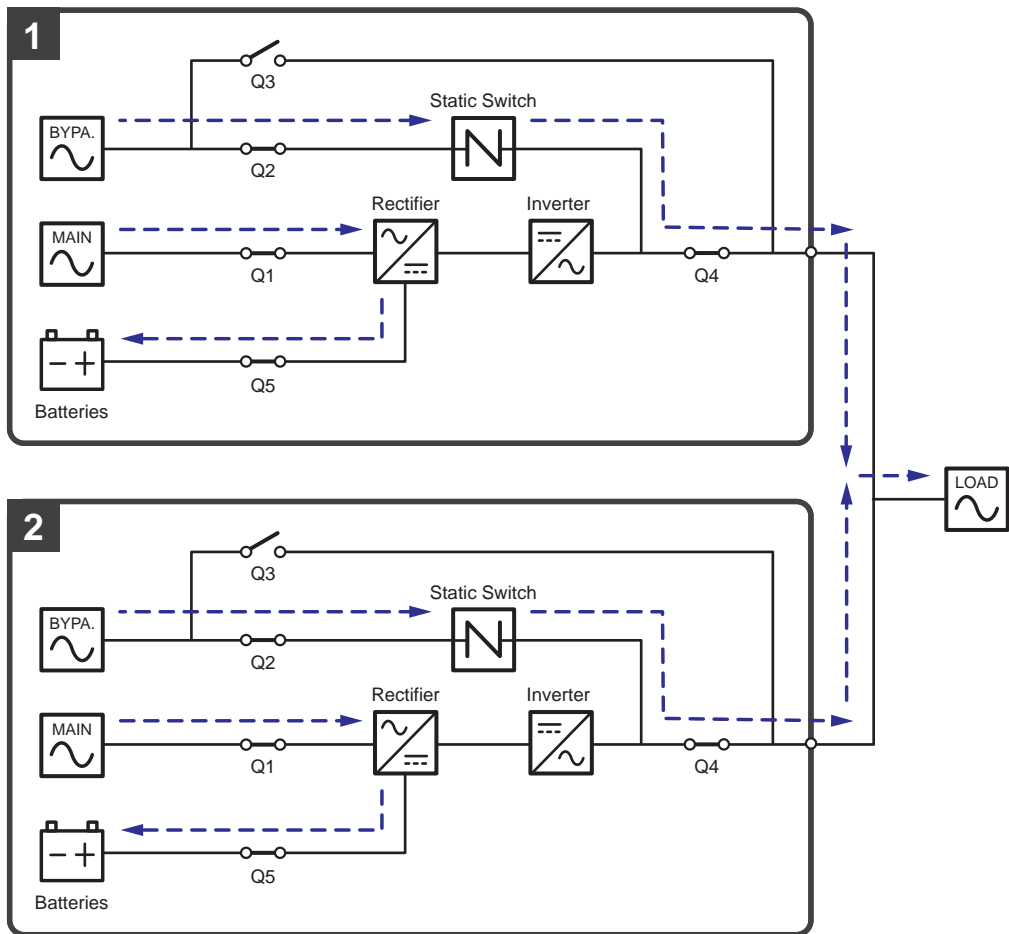

(Figure 3-23: Bypass Mode Diagram_ Dual Input Parallel Units)

3.2.11 Manual Bypass Mode_ Dual Input_ Parallel Units



WARNING:

1. In Manual Bypass mode, make sure that all of the breakers (except each UPS's External Manual Bypass Breaker (Q3)) are in the **OFF** position before working on any of the parallel UPSs' internal circuits. This avoids electric shock.
2. After the power inside each of the parallel UPSs is completely cut off, there is no high voltage inside all parallel UPSs and maintenance can be performed safely. However, to avoid electric shock, please do not touch the following parts on each parallel UPS: AC Input terminal block, Bypass Input terminal block, UPS Output terminal block, Battery Input terminal block, grounding terminals (see **Figure 2-7 ~ Figure 2-9** for the location of these terminal blocks and terminals) and any copper bars connected to the External Manual Bypass Breaker (Q3), as they may carry high voltage.
3. During Manual Bypass mode, each parallel UPS's input power is completely cut off and the connected critical loads are not protected.
4. For parallel UPSs, if you want to turn off one of the parallel UPSs for maintenance, please make sure the total connected critical loads will not exceed the remaining parallel units' total capacity.

In Manual Bypass mode (parallel), if one of the parallel UPSs needs maintenance, please first confirm that the bypass AC source and each parallel UPS's STS module are normal. After confirmation, please follow the procedures below to manually switch each of the parallel UPSs to Manual Bypass mode.

- 1 Tap each LCD's ON/ OFF Button () and the '**POWER OFF?**' screen will pop up to ask if you want to power off the UPS's inverter. Please select '**YES**'.
- 2 Turn **ON** each UPS's External Manual Bypass Breaker (Q3).
- 3 Turn **OFF** each UPS's Bypass Breaker (Q2).
- 4 Turn **OFF** each UPS's Input Breaker (Q1) and Output Breaker (Q4).
- 5 Turn **OFF** each external battery cabinet's breaker (Q5).

In Manual Bypass mode, all power inside the parallel UPSs is completely cut off and maintenance personnel can perform maintenance safely. Power of the connected critical loads will be supplied by manual bypass. During Manual Bypass mode (parallel), all parallel UPSs' tri-color LEDs and LCDs are off. Please see **Figure 3-24** for the path of electrical power through the parallel UPSs in Manual Bypass mode.

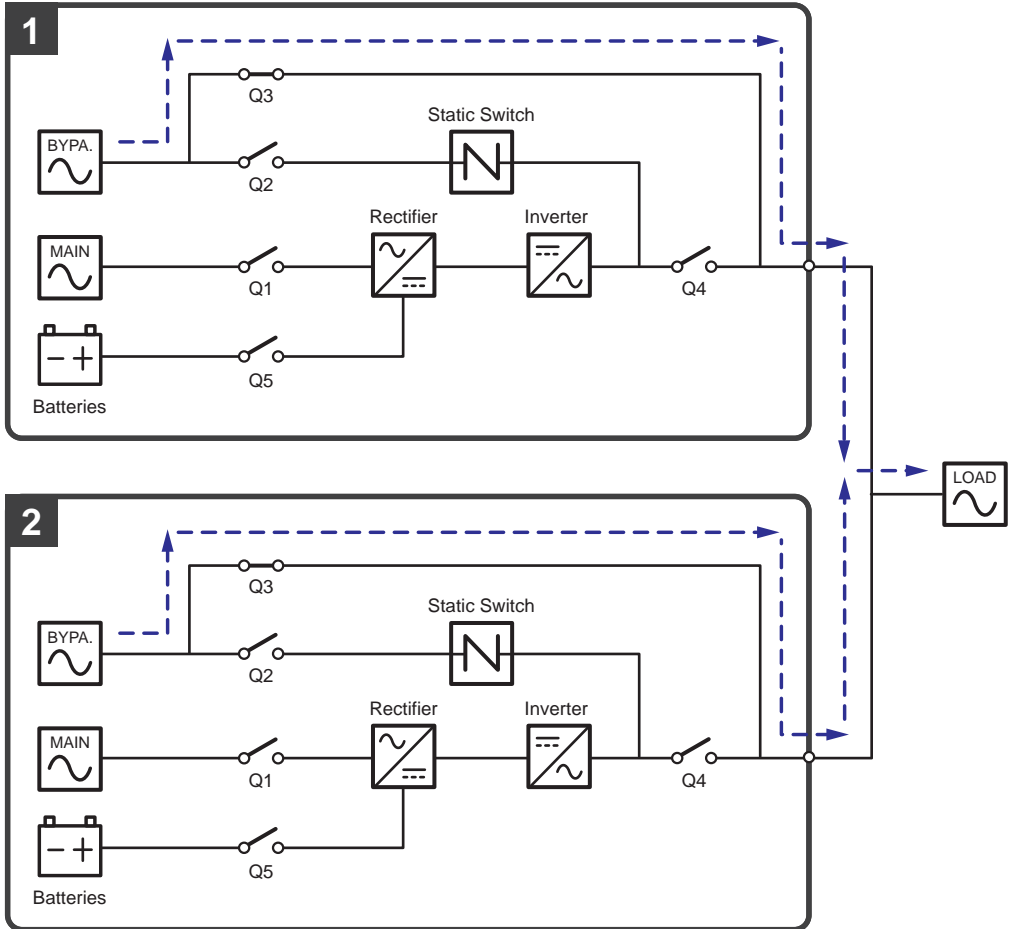

(Figure 3-24: Manual Bypass Mode Diagram_ Dual Input Parallel Units)

3.2.12 ECO Mode_ Dual Input_ Parallel Units

To activate ECO mode, please refer to **6.2.5 ECO Mode Start-up Procedures**, **7.6 Main Screen** and **7.10.2 Mode Setting**.

In ECO mode (parallel), when each parallel UPS's bypass input voltage and frequency are within the range of rating voltage $\pm 10\%$ and rating frequency $\pm 3\text{Hz}$, each parallel UPS works in Bypass mode; otherwise, each parallel UPS runs in On-Line mode. During ECO mode (parallel), each UPS's tri-color LED illuminates green and each UPS's LCD shows the text 'ECO' in the upper right corner. Please see **Figure 3-25** for the path of electrical power through the parallel UPSs in ECO mode.

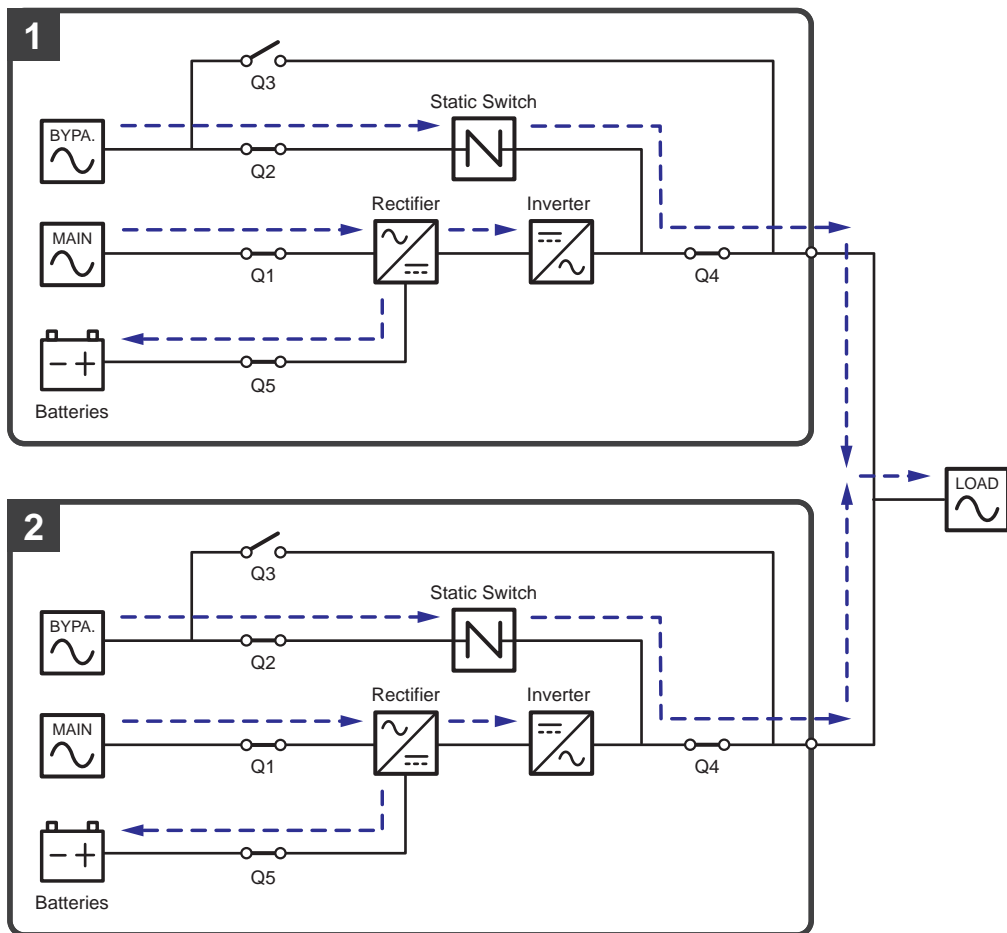

(Figure 3-25: ECO Mode Diagram_ Dual Input Parallel Units)

3.3 Hot Standby Redundancy (Only For Dual Input & At Least Two UPSs)

To provide customers more application choices, the UPS with a dual-input configuration can have a hot standby redundancy function. If you use two UPSs and wish them to work in hot standby redundancy mode, please connect the output of UPS1 to the bypass input of UPS 2. Please see **Figure 3-26**.

For more information about the hot standby redundancy application, please contact service personnel.

In normal condition, it is the UPS 2 inverter that supplies power to the critical loads. Both UPS 1 & UPS 2 tri-color LEDs illuminate green.

When the UPS 2 inverter becomes abnormal, the UPS 2 will automatically transfer to bypass mode and the UPS 1 inverter will supply power to the critical loads. Under such circumstances, the UPS 1 tri-color LED illuminates green and the UPS 2 tri-color LED illuminates yellow.

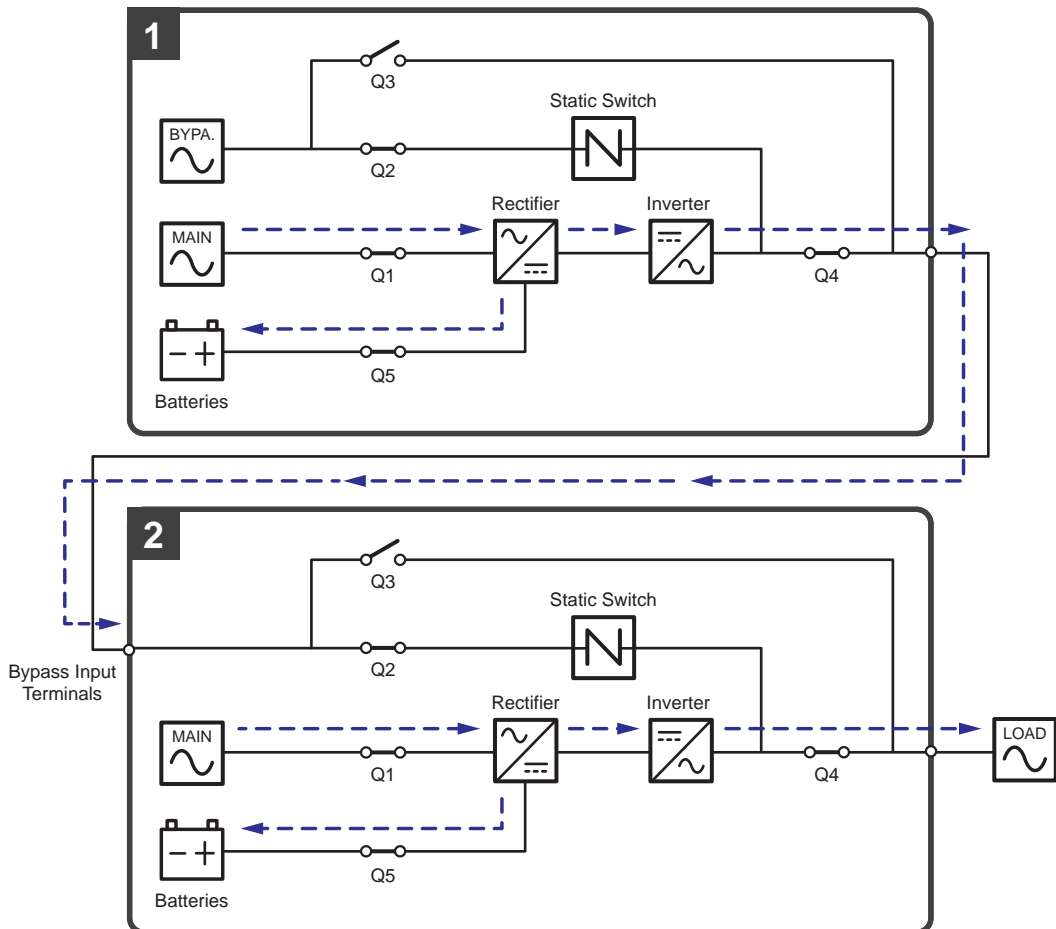

(Figure 3-26: Hot Standby Redundancy Diagram (only for Dual Input & at Least Two UPSs))

3.4 Common Battery (Only for Parallel UPSs connecting to the Same External Battery Cabinet(s))



NOTE:

1. The 'common battery' information in this chapter is only applicable to the UPS using lead-acid batteries. If you need information about lithium-ion batteries, please refer to the user manual of the lithium-ion batteries.
2. Whether using the lead-acid batteries or the lithium-ion batteries, please contact Delta customer service for battery configurations or settings.

To save on your costs and installation space, the parallel UPSs can share their connected external battery cabinet(s). For common battery application, please install a protective device between each parallel UPS and its connected external battery cabinet(s). For relevant information about the protective device, please refer to **5.6 External Battery Cabinet Connection Warnings**. Please see **Figure 3-27** for two parallel UPSs sharing one external battery cabinet as an example.

If the parallel UPSs share the external battery cabinet(s), you should use the LCD to set up relevant parameters such as '**Battery Type**', '**Capacity**', '**Battery Strings**', '**Float Charge Voltage**', '**Equalized Charge Voltage**'*¹, '**Charge Current (Max)**', etc. For more information, please refer to **7.10.4 Battery & Charging Setting**.



NOTE:

For common battery application, please use the LCD to set each UPS's float charge voltage (default: 190V) the same, each UPS's equalized charge voltage*¹ (if applicable, default: 196V) the same, and each UPS's battery strings and charge current (Max) even. For example:

When (1) two UPSs are paralleled and share one external battery cabinet, (2) the lead-acid batteries are used, (3) the battery capacity is 200AH, (4) there are a total of 4 battery strings, and (5) the charge current (Max) is 80A, please use the LCD to set each UPS's '**Battery Type**' as '**VRLA**', '**Capacity**' as 200AH, '**Battery Strings**' as 2, and '**Charge Current (Max)**' as 40A.

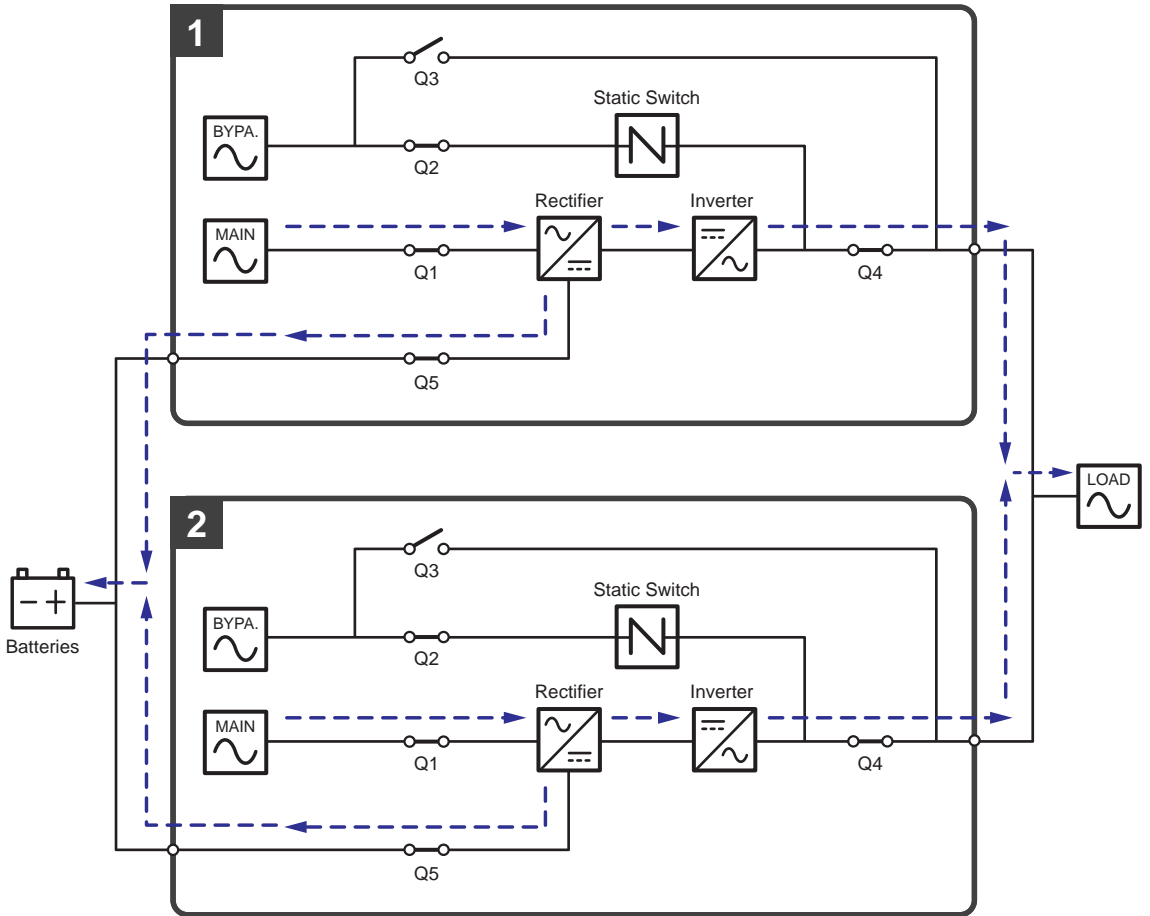

(Figure 3-27: Common Battery Diagram_ only for Parallel UPSs Connecting to the Same External Battery Cabinet(s))

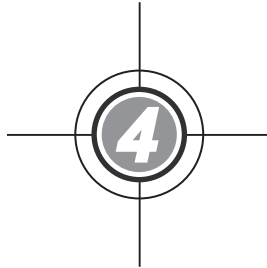

Communication Interfaces

4.1 Communication Interfaces on the Front of the UPS with Front Door Open

4.2 Communication Interfaces at the Rear of the Touch Panel

The communication interfaces are hot swappable and located at two different places. One is on the front of the UPS with front door open and the other is at the rear of the touch panel. Please see **Figure 4-1**.

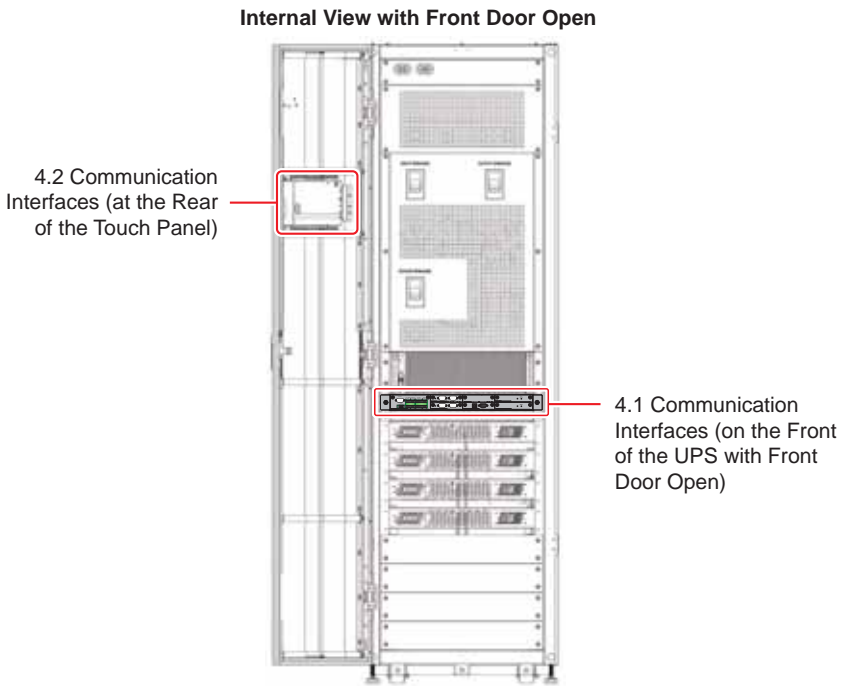

(Figure 4-1: Communication Interfaces Location)

4.1 Communication Interfaces on the Front of the UPS with Front Door Open

The following communication interfaces are located on the front of the UPS with front door open. Please refer to **Figure 4-2** and the table below.

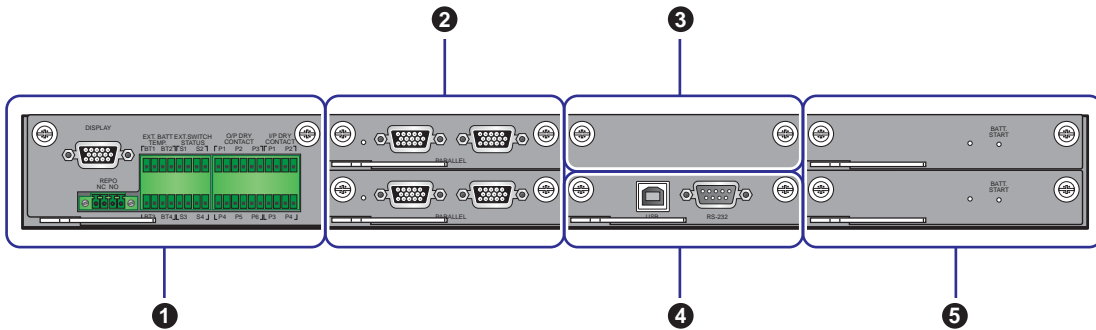

(Figure 4-2: Communication Interfaces_ on the Front of the UPS with Front Door Open)

No.	Item	Q'ty	Description
①	Dry Contact Card	1 PC	Includes a display port, REPO dry contacts, external battery temperature dry contacts, external switch/ breaker status dry contacts, output dry contacts and input dry contacts.
②	Parallel Communication Card	2 PCS	Each card includes two parallel ports and one LED indicator.
③	SMART Slot	1 PC	You can install the optional Relay I/O card in the slot for dry contact expansion.
④	System Control Card	1 PC	Includes a USB port and an RS-232 port.
⑤	Auxiliary Power Card	2 PCS	Each card includes a LED indicator and a battery start button.

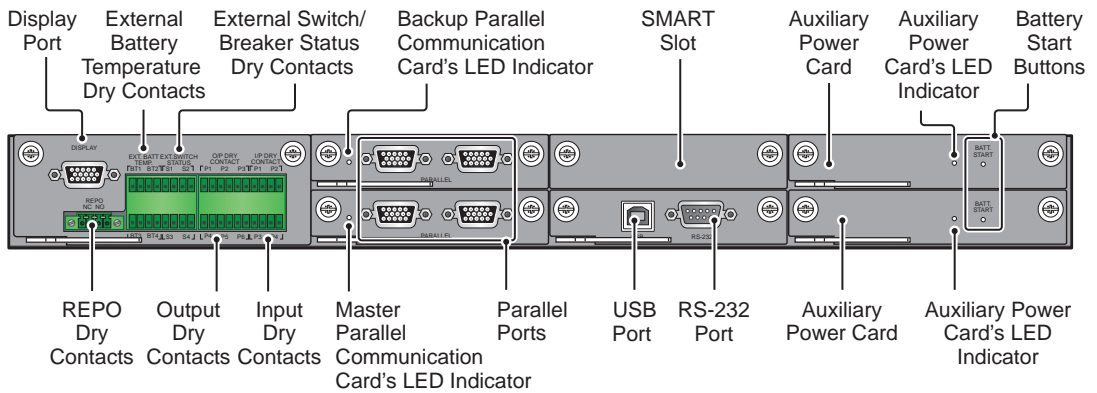

(Figure 4-3: Functions of Communication Interfaces)

4.1.1 Display Port

Before shipment, the display port has been connected to the 10" touch panel with the designated cable in Delta factory.

4.1.2 REPO Dry Contacts

The REPO dry contacts provide you with quick and convenient interfaces to shut down the UPS safely when an emergency occurs. Connect the REPO dry contacts to a user-supplied switch and you can remotely shut down the UPS. The REPO dry contacts provide normally open (NO) and normally closed (NC) these two options for use.

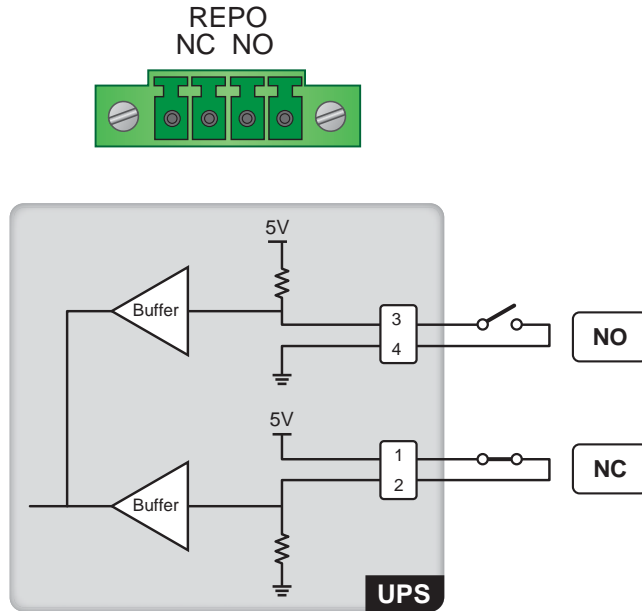

(Figure 4-4: REPO Dry Contacts Design)



NOTE:

If you want to enable the normally closed (NC) function, please take out the dry contact card (see **Figure 4-5**) and remove its Jump CNR3 (see **Figure 4-6**) before you turn on the UPS.

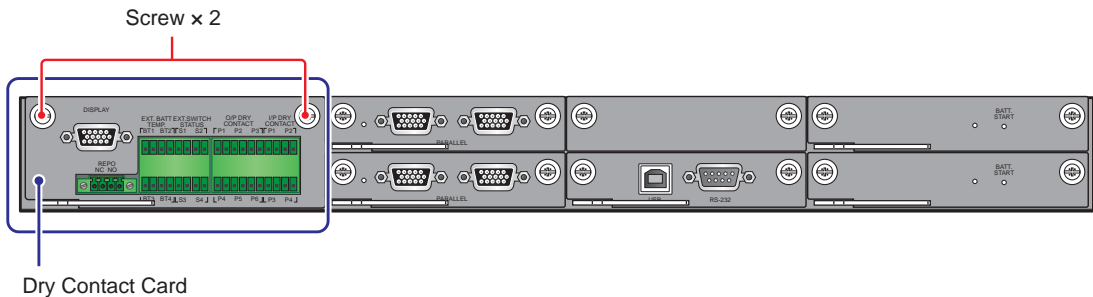

(Figure 4-5: Dry Contact Card Location)

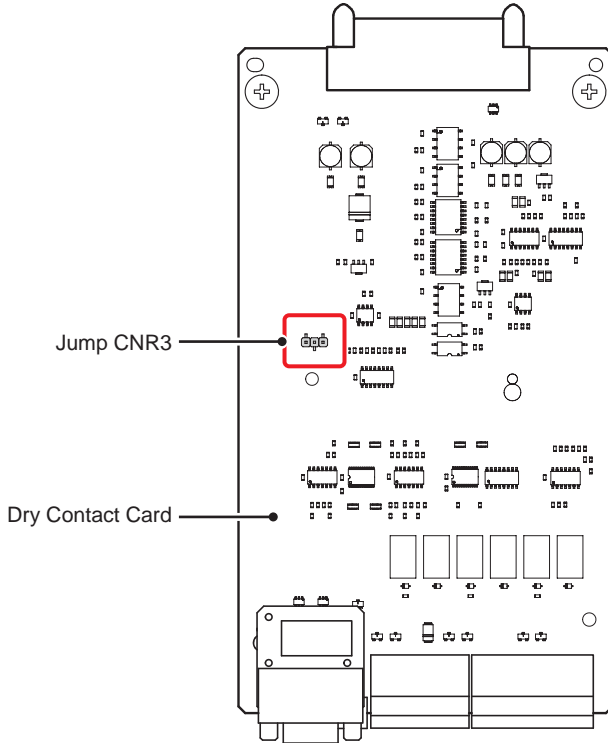

(Figure 4-6: Jump CNR3 Location)

4.1.3 External Battery Temperature Dry Contacts

You can use the external battery temperature dry contacts (BT1, BT2, BT3 and BT4) to detect at maximum four external battery cabinets' temperature. You need to purchase the battery cabinet temperature sensor cable (optional).

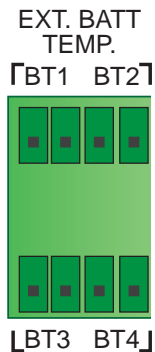

(Figure 4-7: External Battery Temperature Dry Contacts Design)

4.1.4 External Switch/ Breaker Status Dry Contacts

There are four sets of external switch/ breaker status dry contacts (S1, S2, S3 and S4), which can be used to respectively detect the status of input, bypass, output and manual bypass switches or breakers. Please follow the table below to connect the dry contacts to normally open (NO) or normally closed (NC) devices.

Type	Connection
Dry Contact_ S1	Normally closed (NC) device
Dry Contact_ S2	Normally closed (NC) device
Dry Contact_ S3	Normally closed (NC) device
Dry Contact_ S4	Normally open (NO) device

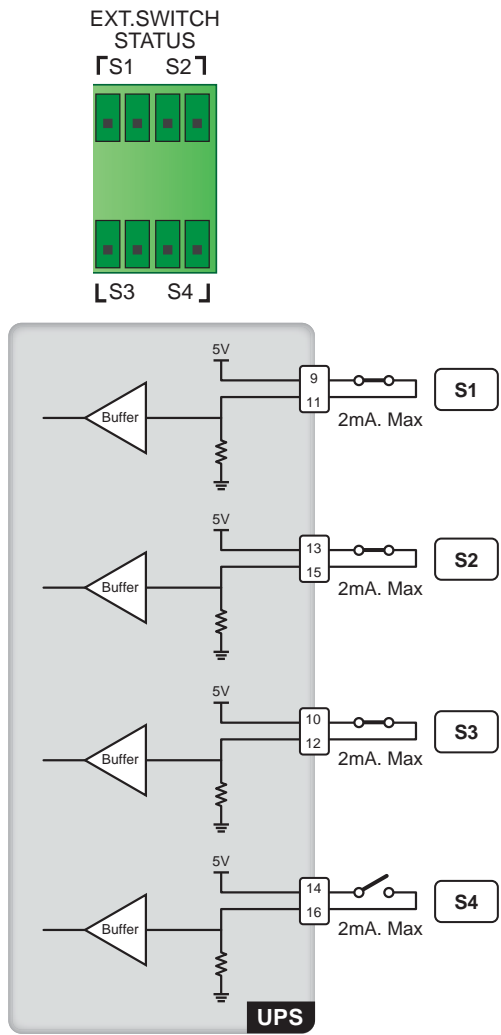

(Figure 4-8: External Switch/ Breaker Status Dry Contacts Design)

No.	Event	Description
1	External input switch or breaker detection.	Detect the external input switch or breaker's status (default: S1).
2	External bypass switch or breaker detection.	Detect the external bypass switch or breaker's status (default: S2).
3	External output switch or breaker detection.	Detect the external output switch or breaker's status (default: S3).
4	External manual bypass switch or breaker detection.	Detect the external manual bypass switch or breaker's status (default: S4).

4.1.5 Output Dry Contacts

There are six sets of programmable output dry contacts (see **Figure 4-9**). Please use the touch panel to set each dry contact as normally open (NO) or normally closed (NC). Each dry contact can be assigned with a specific event. Six out of twenty-one events can be assigned according to your applications. For the twenty-one events, please refer to the table below. To learn how to set up, please contact your local dealer and refer to **7.10.6 Dry Contact Setting**.



NOTE:

Since the output dry contacts belong to the secondary circuit, the voltage of each dry contact's connected device should not exceed 60Vdc/ 42Vac to avoid electric shock and insufficient insulation.

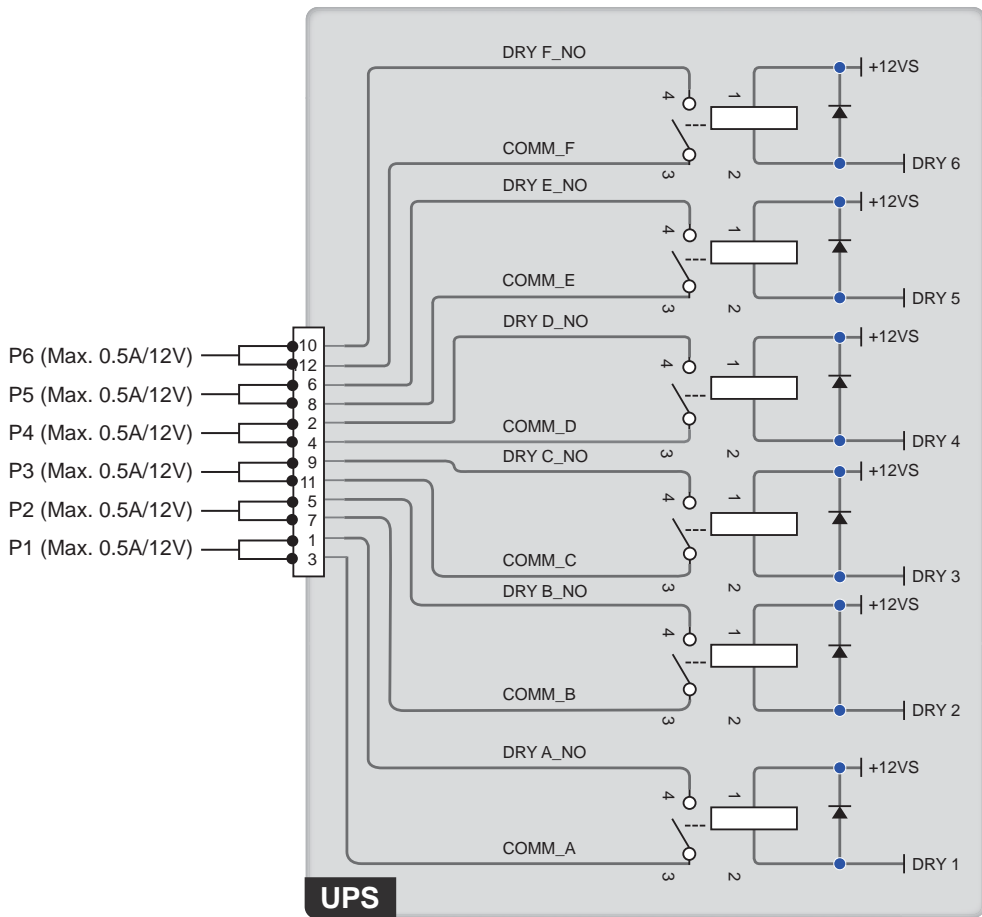
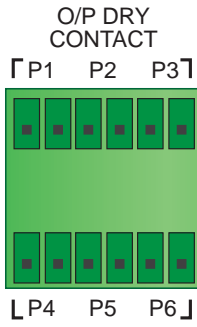

(Figure 4-9: Output Dry Contacts Design)

No.	Event	Description
1	None	No set-up.
2	Load On Inverter	The UPS works in online mode.
3	Load On Bypass	The UPS works in bypass mode.
4	Load On Battery	When the main AC source fails, the batteries supply power to the critical loads.
5	Battery Low	When the UPS runs in battery mode, battery voltage is lower than the setup limit (default: 154Vdc).
6	Bypass Input Abnormal	The bypass voltage, frequency or phase sequence is abnormal.
7	Battery Test Fail	During the battery test, the battery voltage is out of the setup limit.
8	Internal Comm. Fail	The #n power module's internal communication is abnormal.
9	External Parallel Comm. Fail (For parallel application only)	In parallel mode, parallel communication is abnormal.
10	Output Overload	The UPS is overloaded or the UPS shuts down to let the bypass supply power to the critical loads.
11	EPO Activated	The EPO button is pressed to urgently power off the UPS.
12	Load On Manual Bypass	The External Manual Bypass Breaker (Q3) is turned on and the UPS transfers to manual bypass mode.
13	Battery Over Temperature	The external battery cabinet's temperature is too high.
14	Output Voltage Abnormal	The output voltage is too high or too low.
15	Battery Need Replacement	The battery replacement date is due.
16	Bypass Over Temperature	The bypass static switch temperature is too high.
17	Bypass Static Switch Fault	The bypass static switch has an open/ short issue.
18	UPS Over Temperature	The UPS temperature is too high.
19	Battery Breaker Shunt Trip	When the EPO button is pressed, the UPS will send a signal to the connected external shunt trip device to cut off the battery power.
20	Backfeed Protection	When a short circuit occurs in the bypass SCR, the UPS will send a signal to the connected external shunt trip device to cut off the backfeed voltage.
21	General Alarm	When any UPS alarm occurs, the UPS will send an I/O signal.

4.1.6 Input Dry Contacts

There are four sets of programmable input dry contacts (see **Figure 4-10**). The input dry contacts allow the UPS to receive external signals from peripheral devices and let the UPS response accordingly. Please use the touch panel to set each dry contact as normally open (NO) or normally closed (NC). Each input dry contact can be assigned with a specific event. There are ten events can be assigned according to your applications. For information about the ten events, please refer to the table below. To learn how to set up, please contact your local dealer and refer to **7.10.6 Dry Contact Setting**.

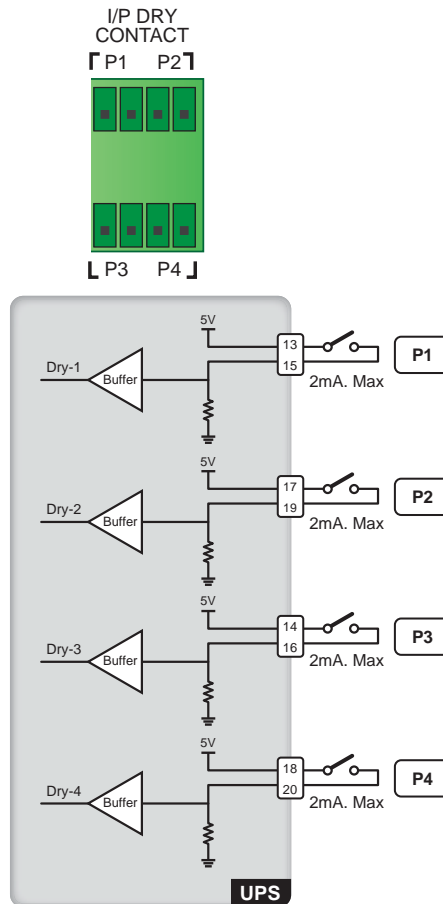

(Figure 4-10: Input Dry Contacts Design)

No.	Event	Description
1	None	No set-up.
2	Generator Status	Generator status detection.
3	Battery Ground Fail	Battery leakage detection.

No.	Event	Description
4	External Battery Breaker Detection	Status detection of the external battery cabinet's breaker or switch.
5	Charger Off (Positive)* ¹	Turn off the charger (positive).
6	Charger Off (Negative)* ¹	Turn off the charger (negative).
7	Battery Abnormal Shutdown	In On-Line mode: the UPS will issue battery abnormal warning. In Battery mode: the UPS will turn to Bypass or Standby mode immediately.
8	Input Transformer OTW	Input transformer over temperature warning.
9	Output Transformer OTW	Output transformer over temperature warning.
10	Battery Fuse Open	The battery fuse is blown.

**NOTE:**

*¹ If you use non-Delta lithium-ion batteries, you must set up **Charger Off (Positive)** and **Charger Off (Negative)** these two items. Please refer to **7.10.4 Battery & Charging Setting** and **7.10.6 Dry Contact Setting** to perform relevant setup. If you have any questions, please contact Delta customer service.

4.1.7 Parallel Communication Cards

The UPS has two parallel communication cards, which are master parallel communication card and backup parallel communication card. Each card has one LED indicator and two parallel ports. Please see **Figure 4-11** and **Figure 4-12** for relevant location.

If both cards work normally, the master parallel communication card's LED indicator will illuminate green and the backup parallel communication card's LED indicator will illuminate yellow.

If one card works normally and the other works abnormally, the normal card's LED indicator will illuminate green and the abnormal card's LED indicator will illuminate red.

During initialization process, both cards' LED indicators flash yellow.

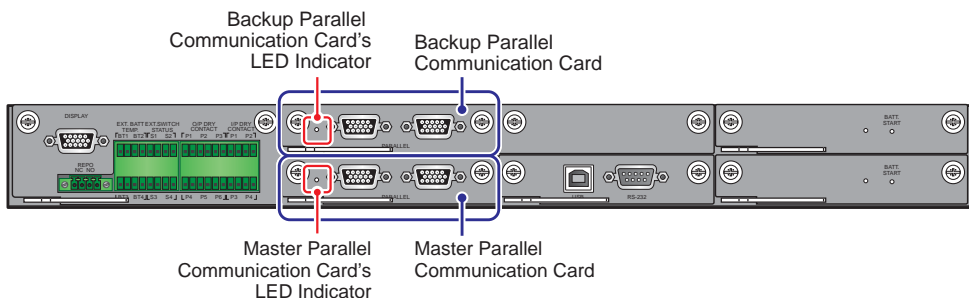

(Figure 4-11: Location of Master and Backup Parallel Communication Cards and Their LED Indicators)

4.1.8 Parallel Ports

The parallel ports (see **Figure 4-12**) are used to connect parallel UPSs to increase the system capacity and redundancy. With the provided parallel cable, up to four UPS units with the same capacity, voltage, frequency and version can be paralleled. For version information, please refer to **7.11.7 Version & S/N**. Please only use the provided parallel cable to parallel the UPS units. Otherwise, parallel functions will fail. To enhance parallel reliability, please adopt Daisy Chain method (see **Figure 5-18 & Figure 5-20**) to execute parallel configuration.



WARNING:

The provided parallel cable is placed in the accessory package. Using other types of cables to connect the parallel UPSs may cause parallel failure, malfunctions and accidents.

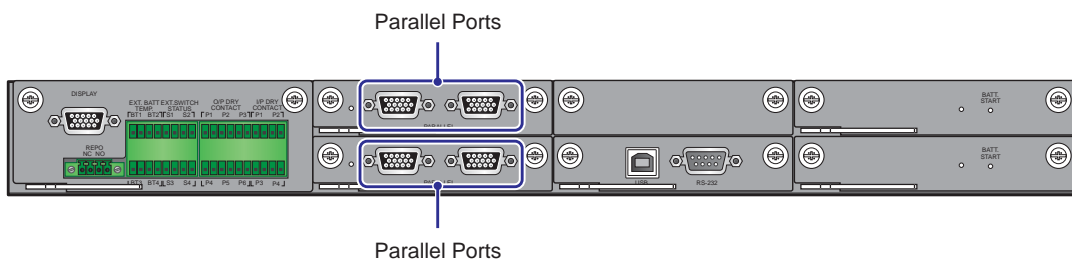

(Figure 4-12: Location of Parallel Ports)

4.1.9 SMART Slot

You can install the optional Relay I/O card (for dry contact expansion) into the SMART slot shown in **Figure 4-13**. For relevant installation and application information, please contact Delta customer service.

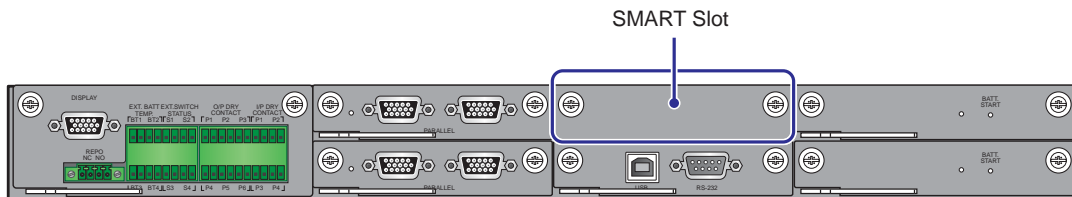

(Figure 4-13: SMART Slot Location)

4.1.10 USB Port & RS-232 Port

You can use the provided RS-232 cable or the USB cable to connect the UPS's RS-232 port or USB port with a computer, and use either the USB port or the RS-232 port to (1) upgrade the firmware of UPS, power modules, system control card and parallel communication cards, and (2) download event logs. For the location of the USB port and RS-232 port, please refer to **Figure 4-14**.



NOTE:

Do not use the RS-232 port and the USB port at the same time.

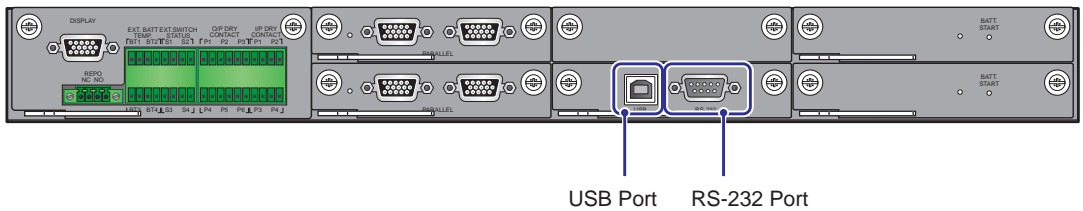

(Figure 4-14: Location of USB Port & RS-232 Port)

4.1.11 Auxiliary Power Cards

The UPS has two auxiliary power cards. Each card has one LED indicator. Please see **Figure 4-15** for their location.

If the auxiliary power card works normally, its LED indicator will illuminate green. If the auxiliary power card is off or abnormal, its LED indicator will be off.



WARNING:

The UPS has two hot-swappable auxiliary power cards. For replacement, you can only replace one card at one time to avoid power interruption.

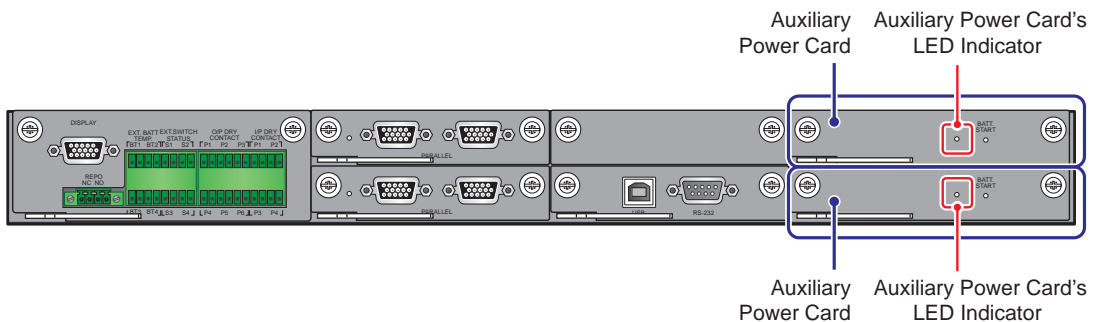

(Figure 4-15: Location of Auxiliary Power Cards and Their LED Indicators)

4.1.12 Battery Start Buttons

Please refer to **Figure 4-16** for the location of battery start buttons. For the battery start buttons' relevant operation information, please refer to **6.2.2 Battery Mode Start-up Procedures**.

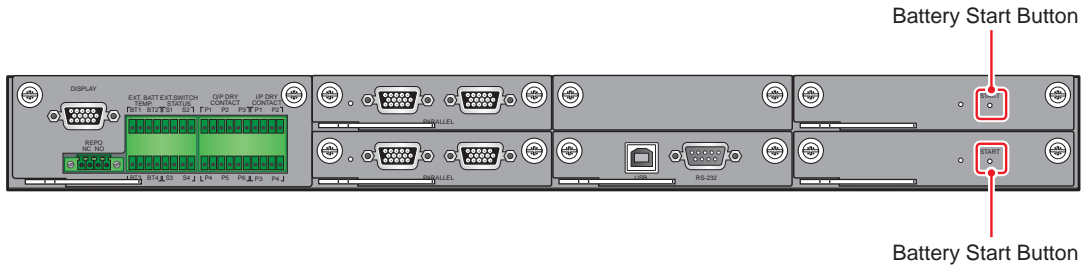



(Figure 4-16: Location of Battery Start Buttons)

4.2 Communication Interfaces at the Rear of the Touch Panel

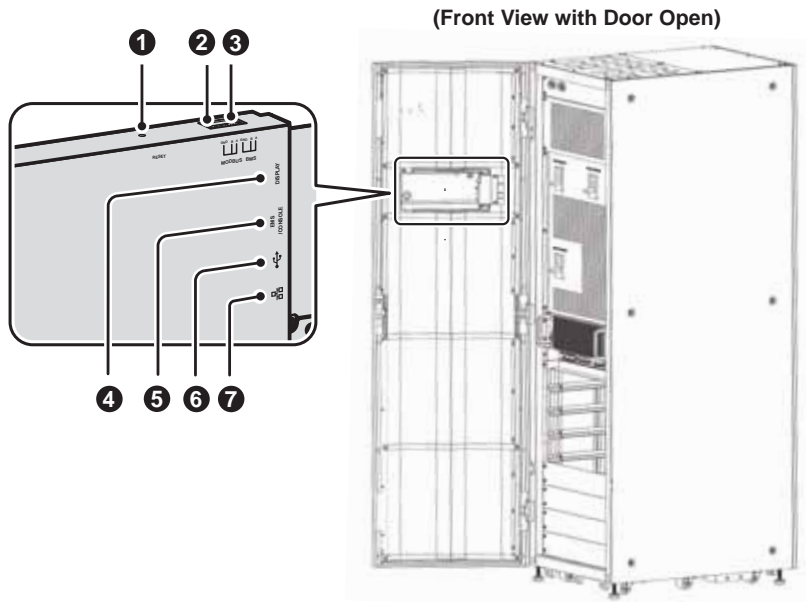
The following communication interfaces are located at the rear of the touch panel. Please refer to **Figure 4-17** and the table below.



(Figure 4-17: Communication Interfaces _ at the Rear of the Touch Panel)

No.	Item	Function
①	RESET	Press the RESET button once to restart the LCD.
②	MODBUS	<ol style="list-style-type: none"> 1. Provides MODBUS communication function. 2. Connects to a user-supplied monitoring system.
③	BMS	Connects to the Delta battery management system (optional). The BMS port application is only applicable to lead-acid batteries. Please refer to 7.10.4 Battery & Charging Setting .
④	DISPLAY	Before shipment, the DISPLAY port has been connected to the display port show in Figure 4-3 with the designated cable in Delta factory.
⑤	EMS/ CONSOLE	Connects to a user-supplied environmental monitoring system or Delta EnviroProbe 1000 (optional).
⑥	 (USB Ports)	There are two USB ports. Connects a user-supplied USB flash drive to any of the USB ports to (1) upgrade the UPS and LCD's firmware and (2) download event logs.
⑦	 (Network Port)	<ol style="list-style-type: none"> 1. Provides SNMP communication function. 2. Connects to a user-supplied monitoring system.

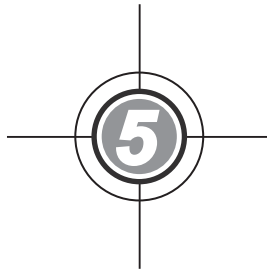

Installation and Wiring

- 5.1 Before Installation and Wiring
- 5.2 Installation Environment
- 5.3 UPS Transportation
- 5.4 Fixing the UPS
- 5.5 Wiring
- 5.6 External Battery Cabinet Connection Warnings
- 5.7 STS Module
- 5.8 Power Module (Optional)

5.1 Before Installation and Wiring

- Please read this user manual thoroughly before installation, wiring and operation.
- Only authorized Delta engineers or service personnel can perform installation, wiring, panel & cover removal, maintenance and operation. If you want to execute any action mentioned above by yourself, the action must be under the supervision of authorized Delta engineers or service personnel.
- If you use a forklift or other equipment to move the UPS, please make sure its load bearing is sufficient. Please refer to **Table 5-1**.
- The UPS must be connected with at least one external battery cabinet (user-supplied, handled and configured by Delta service personnel). Please refer to **5.6 External Battery Cabinet Connection Warnings** for relevant information.
- In this user manual, the meaning of Q1, Q2, Q3, Q4 and Q5 represents the following.

Code	Meaning
Q1	Input Breaker
Q2	Bypass Breaker
Q3	External Manual Bypass Breaker
Q4	Output Breaker
Q5	External Battery Cabinet's Breaker

5.2 Installation Environment

- Install the UPS indoors. Do not place it outdoors.
- Make sure that transportation routes (e.g. corridors, door gates, elevators, etc.) and installation area can accommodate and bear the weight of the UPS, external battery cabinet(s) and handling equipment. Please refer to **Table 5-1** for floor weight loading information. Please note that the power module Q'ty is designed as N + 1 redundancy.

Table 5-1: UPS Floor Weight Loading Table

DPH Series UPS_ 15 ~ 105kVA							
UPS Capacity	15kVA/ 15kW	30kVA/ 30kW	45kVA/ 45kW	60kVA/ 60kW	75kVA/ 75kW	90kVA/ 90kW	105VA/ 105kW
Power Module Q'ty	1+1	2+1	3+1	4+1	5+1	6+1	7+1

DPH Series UPS_ 15 ~ 105kVA							
UPS Capacity	15kVA/ 15kW	30kVA/ 30kW	45kVA/ 45kW	60kVA/ 60kW	75kVA/ 75kW	90kVA/ 90kW	105VA/ 105kW
Weight	711 lb	756 lb	802 lb	848 lb	893 lb	939 lb	985 lb
	322 kg	343 kg	364 kg	385 kg	405 kg	426 kg	447 kg
Weight Loading	130 lb/ft ²	138 lb/ft ²	146 lb/ft ²	154 lb/ft ²	163 lb/ft ²	171 lb/ft ²	179 lb/ft ²
	632 kg/m ²	673 kg/m ²	713 kg/m ²	754 kg/m ²	795 kg/m ²	835 kg/m ²	876 kg/m ²

- The UPS adopts top cable entry. Please leave adequate space for wiring, maintenance, and ventilation as follows:
 1. 31.5" (80 cm) from the front of the UPS.
 2. 11.8" (30 cm) from the back of the UPS.
 3. 19.7" (50 cm) from the top of the UPS.
- The UPS adopts the design of air inlet at the front and air outlet at the rear.

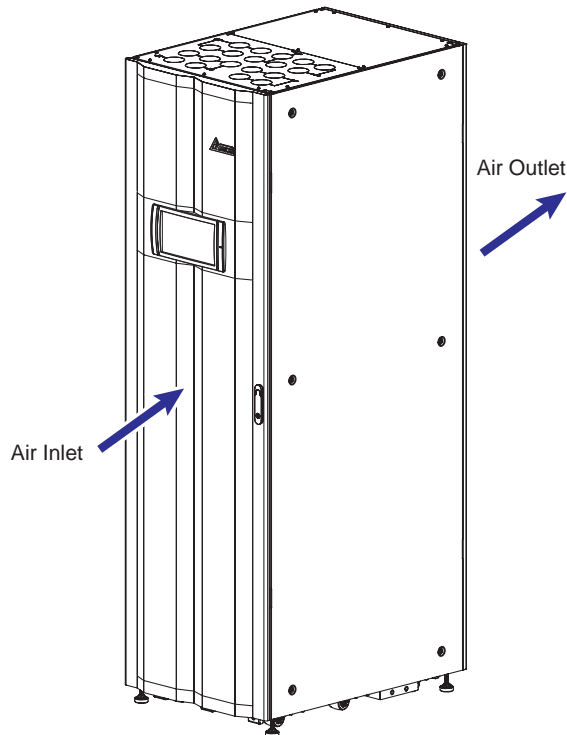

(Figure 5-1: UPS Air Inlet & Outlet Direction)



WARNING:

1. Do not use air conditioners or similar equipment to blow into the rear of the UPS.
 2. Do not hinder ventilation of the UPS.
- Keep the installation area clean and the wiring cables enclosed to prevent damage from rodents. We recommend the use of wiring ducts.
 - Keep the installation area's temperature around 77°F (25°C) and humidity within 90%. The highest operating altitude is 3300 ft (1000 m) above sea level.
 - For safety concerns, we suggest that you:
 1. Equip surroundings of the installation area with CO₂ or dry powder fire extinguishers.
 2. Install the UPS in an environment where fireproof materials are used to construct the walls, floors and ceilings.
 3. Install the UPS on a floor that is made of noncombustible materials.
 - Do not allow unauthorized personnel to enter the installation area and do assign specified personnel to keep the UPS key.

5.3 UPS Transportation

- At the bottom of the UPS, there are casters to help you to move the UPS to a designated area. Before moving the UPS, please turn the four leveling feet counterclockwise to raise them off the ground. This protects the leveling feet from damage while moving. Please arrange sufficient manpower (at least six people) and equipment (e.g. forklift) to carefully move the UPS from its pallet to ground. Please pay attention to the movement of the casters to avoid accidents.

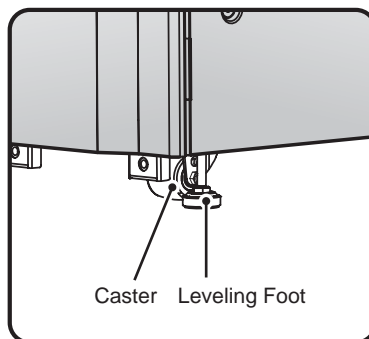

(Figure 5-2: UPS Leveling Foot and Caster)

**WARNING:**

1. The UPS is fixed on the pallet with two balance supports and six M10 screws. When taking apart the two balance supports from the UPS, pay attention to the movement of the casters to avoid accidents.
 2. Please refer to the **Unpacking Guide** attached to the UPS external wooden box for the location of the balance supports.
- The casters are designed to move on level ground. Do not move the UPS on an uneven surface. This might cause damage to the casters or tip the UPS which could damage the unit.
 - After the UPS has been removed from the pallet to the ground, we suggest that at least three people move the UPS to the installation area. With their two hands, one person holds a lateral side of the UPS, another person holds the other lateral side of the UPS, and the other person pushes the UPS, either from the front side or from the backside, to move the unit to the installation area. This is the best way to avoid tipping the UPS.
 - If you need to move the UPS over a long distance, please use appropriate equipment (e.g. forklift). Do not use the UPS casters to move the unit over a long distance.

5.4 Fixing the UPS

**NOTE:**

When handling or moving the UPS, please use appropriate equipment (e.g. forklift).

Please follow the steps below:

- 1) Before fixing the UPS in a designated installation area, please double check whether the area's floor weight loading is sufficient to bear the UPS, external battery cabinet(s) and handling equipment (e.g. forklift) to avoid accidents. For UPS floor weight loading information, please refer to **Table 5-1**.
- 2) After the UPS is moved to the designated installation area, use a 17 mm socket wrench to stabilize the four leveling feet on the floor. Please note that the UPS must stand on the floor stably and levelly without any tipping.
- 3) Use six M10 screws (three for the front and three for the rear) and six expansion screws and nuts (three for the front and three for the rear) to fix the UPS on the ground with two balance supports. Please refer to **Figure 5-3 ~ Figure 5-4**. The six M10 screws and the two balance supports are those been taken apart from the UPS earlier while moving the UPS from the pallet to the ground (see **5.3 UPS Transportation**). As for the six expansion screws and nuts, they should be provided by qualified service personnel.

**WARNING:**

You must stabilize the UPS with the two provided balance supports. Otherwise, the UPS might tip over.

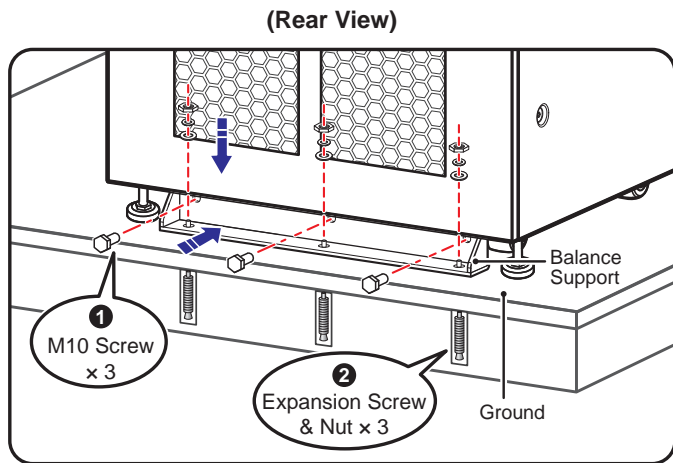
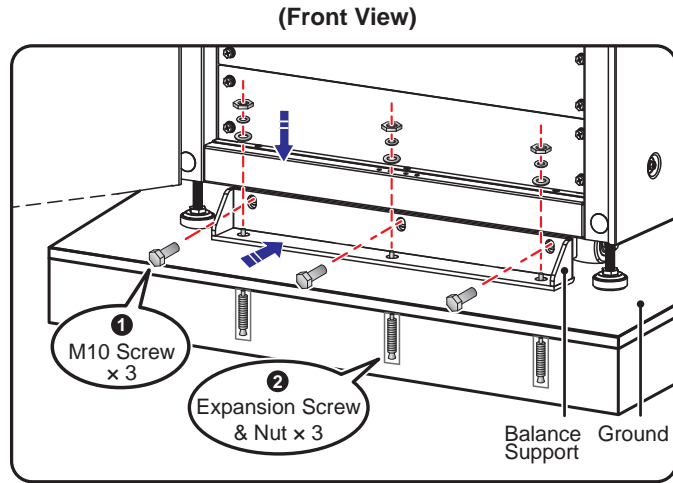

NOTE:

Please contact Delta service personnel for the expansion screws and nuts. The two balance supports and the six M10 screws are already provided with the UPS.

- 4 Follow **5.5 Wiring** to perform wiring procedures.
- 5 Follow **5.6 External Battery Cabinet Connection Warnings** to connect the external battery cabinet(s).
- 6 Follow **5.8 Power Module (Optional)** to install the power modules.
- 7 After finishing the procedures above, close the UPS front door.

5.5 Wiring

5.5.1 Pre-wiring Warnings

**WARNING:**

1. Before wiring, please ensure that you have followed **5.4 Fixing the UPS** to fix the UPS in the designated installation area firmly.
 2. Before wiring, please read **5.5 Wiring** thoroughly.
 3. Only authorized Delta engineers or service personnel can perform installation, wiring, panel & cover removal, maintenance and operation. If you want to execute any action mentioned above by yourself, the action must be under the supervision of authorized Delta engineers or service personnel.
- Before wiring or making any electrical connection, make sure that the power supplied to the input and output of the UPS is completely cut off.
 - The UPS adopts top cable entry. Please leave adequate space on the top of the UPS to allow cable entry.
 - Check that the size, diameter, phase, polarity are correct for each cable that needs connecting to the UPS and external battery cabinet(s). Please refer to **Table 5-2** for the specifications of input/ output/ battery cables and breakers.

Table 5-2: Specifications of Input/ Output/ Battery Cables and Breakers

**NOTE:**

1. **Table 5-2** is based on (a) default input/ output voltage: 120V, (b) battery Q'ty: 28 PCS, and (c) default charge current for the UPS: 10A.
2. For other conditions different from **Table 5-2**, please contact Delta service personnel for relevant values.

DPH 15 ~ 105kVA								
Capacity		15kVA/ 15kW	30kVA/ 30kW	45kVA/ 45kW	60kVA/ 60kW	75kVA/ 75kW	90kVA/ 90kW	105kVA/ 105kW
Power Module Q'ty		1+1	2+1	3+1	4+1	5+1	6+1	7+1
Input	Rated current at input voltage 120V (in the status of battery charging)	46A	92A	138A	184A	230A	276A	320A
	Recommended cable size (L1/ L2/ L3/ N/ PE)	6 AWG (13 mm ²) × 1 PC	2 AWG (33 mm ²) × 1 PC	2/ 0 AWG (67 mm ²) × 1 PC	4/ 0 AWG (107 mm ²) × 1 PC	1/ 0 AWG (53 mm ²) × 2 PCS	3/ 0 AWG (85 mm ²) × 2 PCS	4/ 0 AWG (107 mm ²) × 2 PCS
	Maximum cable size (L1/ L2/ L3/ N/ PE)	4/ 0 AWG (107 mm ²) × 2 PCS						
	Cable lug width	1.3" (32 mm)						
	Screw size	M10						
	Terminal type*1	RNB 14-10	RNBS 38-10	RNB 70-10	RNB 100-10	SQNBS 60-10	SQNBS 80-10	SQNBS 100-10
Output/ Bypass	Rated current at output voltage 120V	42A	84A	125A	167A	209A	250A	292A
	Recommended cable size (L1/ L2/ L3/ N/ PE)	6 AWG (13 mm ²) × 1 PC	2 AWG (33 mm ²) × 1 PC	2/ 0 AWG (67 mm ²) × 1 PC	4/ 0 AWG (107 mm ²) × 1 PC	1/ 0 AWG (53 mm ²) × 2 PCS	3/ 0 AWG (85 mm ²) × 2 PCS	3/ 0 AWG (85 mm ²) × 2 PCS
	Maximum cable size (L1/ L2/ L3/ N/ PE)	4/ 0 AWG (107 mm ²) × 2 PCS						
	Cable lug width	1.3" (32 mm)						
	Screw size	M10						
	Terminal type*1	RNB 14-10	RNBS 38-10	RNB 70-10	RNB 100-10	SQNBS 60-10	SQNBS 80-10	SQNBS 80-10
Battery	Nominal discharge current (condition: per cell 2V)	48A	95A	143A	190A	238A	285A	330A
	Recommended cable size (+/ -/ N/ PE)	6 AWG (13 mm ²) × 1 PC	1/0 AWG (53 mm ²) × 1 PC	3/ 0 AWG (85 mm ²) × 1 PC	1/ 0 AWG (53 mm ²) × 2 PCS	1/ 0 AWG (53 mm ²) × 2 PCS	3/ 0 AWG (85 mm ²) × 2 PCS	4/ 0 AWG (107 mm ²) × 2 PCS

DPH 15 ~ 105kVA								
Capacity		15kVA/ 15kW	30kVA/ 30kW	45kVA/ 45kW	60kVA/ 60kW	75kVA/ 75kW	90kVA/ 90kW	105kVA/ 105kW
Battery	Maximum cable size (+/- N/ PE)	4/ 0 AWG (107 mm ²) × 2 PCS						
	Cable lug width	1.3" (32 mm)						
	Screw size	M10						
	Terminal type* ¹	RNB 14-10	RNBS 60-10	RNB 80-10	SQNBS 60-10	SQNBS 60-10	SQNBS 80-10	SQNBS 100-10
Tightening Torque		M10 = 217 ± 8.7 lbf-in (250 ± 10 kgf-cm)						
Conduit Size		2" (50.8 mm)						
Cable Q'ty		3 PCS per conduit						
Input Breaker (Q1)		400A	400A	400A	400A	400A	400A	400A
Bypass Breaker (Q2)		400A	400A	400A	400A	400A	400A	400A
External Manual Bypass Breaker (Q3)		63A	125A	175A	225A	300A	350A	400A
Output Breaker (Q4)		400A	400A	400A	400A	400A	400A	400A
External Battery Cabinet's Breaker (Q5)		63A	125A	175A	250A	300A	350A	400A



NOTE:

1. In accordance with National Electrical Codes (NEC), please install a suitable conduit and bushing for cable protection.
2. Please refer to national and local electrical codes for acceptable non-fuse breakers and cable sizes.
3. Use 194°F (90°C) copper wires.
4. *¹ The suggested manufacturer is **K.S. TERMINALS INC.** You may use equivalent terminals provided by other manufacturers.

- To avoid UPS failure, the input of the UPS must be Y connection.
- If there is a floating voltage between the input power's neutral (N) and the ground (⊕), and you require that the VNG of the UPS should be zero, we suggest that you install an isolation transformer in front of the input side of the UPS, and connect the isolation transformer's secondary neutral (N) and the ground (⊕) to the nearest place of the transformer.
- The main AC source must be a three-phase four-wire system and meets the specifications specified on the UPS rating label. For main AC source connection, make sure it is in positive phase sequence. Please refer to **5.5.3 Single Unit Wiring** and **5.5.4 Parallel Units Wiring** for wiring information.

- Check the battery polarity when connecting the external battery cabinet(s) to the UPS. Do not connect the battery polarity in reverse. For battery connection relevant information, please refer to **5.6 External Battery Cabinet Connection Warnings**.

- Connect the external battery cabinet's grounding terminal (⊕) to the UPS's grounding terminal (⊕). Please refer to **Figure 5-15** and **Figure 5-19** for grounding information.
- The UPS's grounding terminal (⊕) must be grounded. Please use ring-type terminals when wiring. For the location of the UPS's grounding terminals (⊕), see **Figure 5-14**.



WARNING:

1. Wrong wiring will cause damage to the UPS and electric shock.
2. For single input, the UPS will not work normally if the main AC power's neutral (N) is not firmly connected or not connected to the UPS's AC Input neutral (N) terminal shown in **Figure 5-6**.

For dual input, the UPS will not work normally if the main AC power's neutral (N) and the bypass power's neutral (N) are not firmly connected or not connected to the UPS's AC Input neutral (N) terminal and Bypass Input neutral (N) terminal respectively. For the AC Input and Bypass Input's neutral (N) terminals, please refer to **Figure 5-6**.

3. If the UPS is not grounded, the power boards and components might be damaged after the UPS is powered on.

5.5.2 Single Input/ Dual Input Modification



WARNING:

Only authorized Delta engineers or service personnel can modify single input/ dual input setup.

The UPS default setting is single input. If you want to modify it into dual input, please follow the procedures below.

- 1 Follow **Figure 5-5** to remove the wire cover and find the copper bars between the AC Input and Bypass Input terminals shown in **Figure 5-6**.

**Internal View
(Front View with Door Open)**

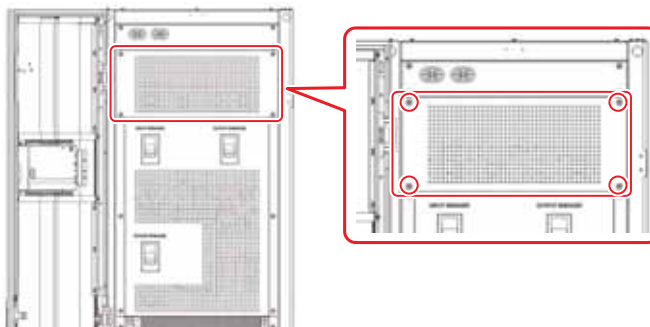

(Figure 5-5: UPS front Panel & Screw Location)

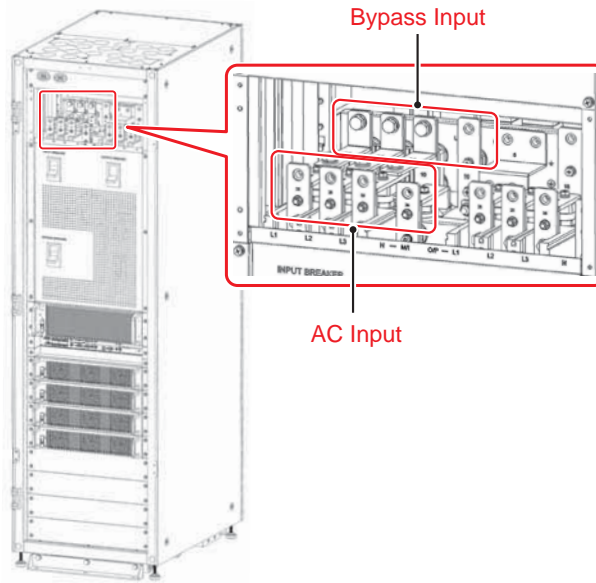

(Figure 5-6: Wiring Terminals_ AC Input and Bypass Input)

- 2) Unscrew the six screws and remove the three copper bars. See **Figure 5-7** and **Figure 5-8**.

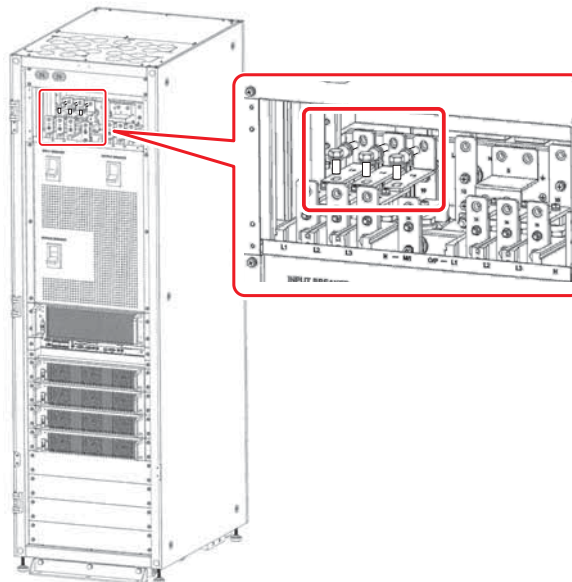

(Figure 5-7: remove the copper bars between the AC Input and Bypass Input Terminals)

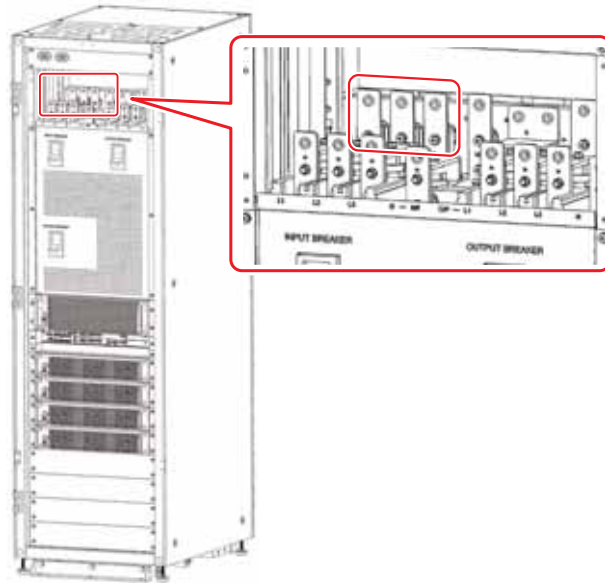

(Figure 5-8: After removing the Copper Bars)

5.5.3 Single Unit Wiring

- **Single Input (Single Unit)**

When there is only one AC power source, single unit wiring procedures are as follows.

- 1 The UPS adopts top wiring. Please leave adequate space on the top of the UPS to allow cable entry.
- 2 Please remove the wire cover (see **Figure 5-9**) to see the wiring terminals shown in **Figure 5-10 ~ Figure 5-11**.

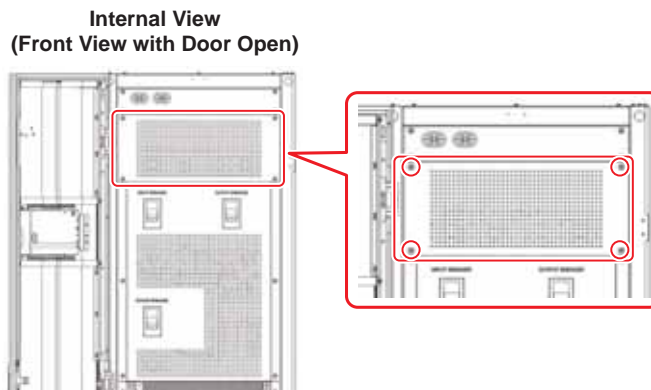

(Figure 5-9: Screw Location)

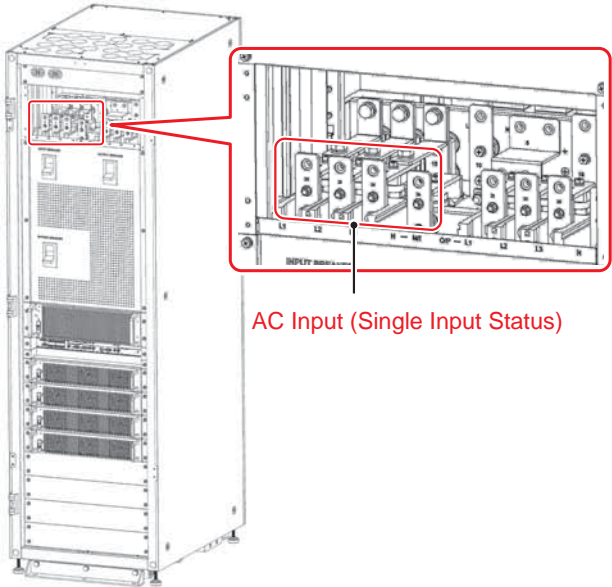

(Figure 5-10: Wiring terminals_ AC input)

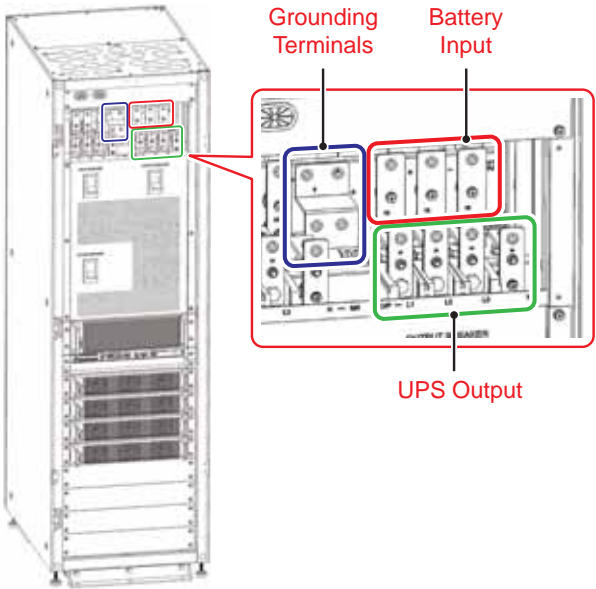

(Figure 5-11: Wiring terminals_ UPS Output & Battery Input & Grounding)

- 3 For wiring, please remove all the round covers on the top, as shown in **Figure 5-12**.

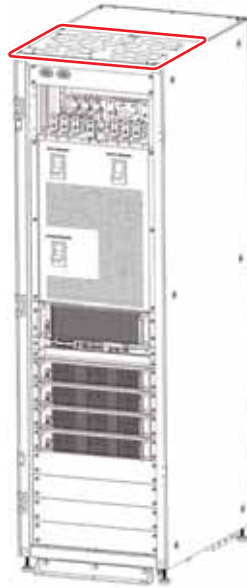

(Figure 5-12: Location of the round Covers)

Table 5-3: Wiring Terminals & Wiring Information

No.	Item	Description	Function
1	AC Input Terminals	Include L1/ L2/ L3/ N terminals.	Connect to the main AC source.
2	Bypass Input Terminals	Include L1/ L2/ L3/ N terminals.	Single Input: there is no need to connect these terminals. Dual Input: connect to the bypass AC source.
3	UPS Output Terminals	Include L1/ L2/ L3/ N terminals.	Connect to the critical loads.
4	Battery Input Terminals	Include +/- N terminals.	Connect to the external battery cabinet.
5	⊕	Includes one grounding terminal.	For the UPS's protective earthing.
6	⊕	Includes two grounding terminals.	Connect to the external battery cabinet's and critical loads' grounding terminals (⊕).

- 4 Make sure the Input Breaker (Q1), Bypass Breaker (Q2) and Output Breaker (Q4) are in the **OFF** position. See **Figure 2-4** for the breakers' location.

- 5) Make sure that each external battery cabinet's breaker (Q5) and External Manual Bypass Breaker (Q3) are in the **OFF** position.
- 6) Follow **Table 5-2** to select proper input, output, and battery cables.
- 7) Connect the main AC source/ output/ external battery cabinet's cables to the UPS. Please refer to **Figure 5-13 ~ Figure 5-14**. For battery connection, please refer to **5.6 External Battery Cabinet Connection Warning**.

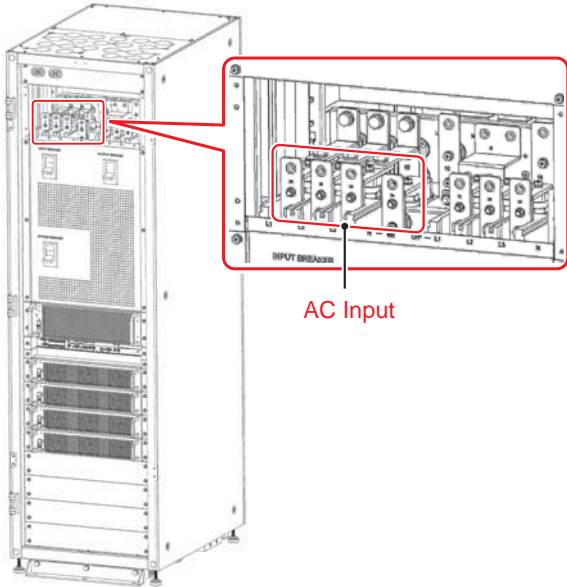

(Figure 5-13: Single Unit Single Input Wiring_ AC Input)

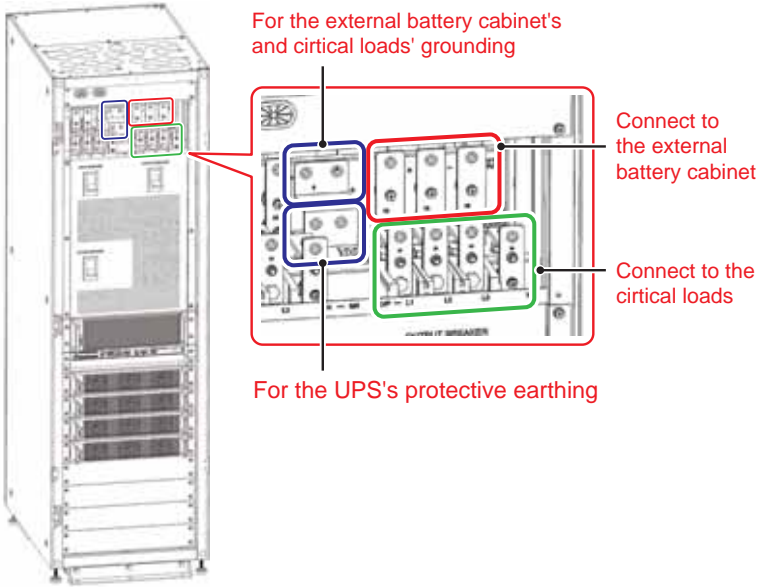

(Figure 5-14: Single Unit Single Input Wiring_ UPS Output & Battery Input & Grounding)

- 8) Follow **Figure 5-15** to ground the UPS, external battery cabinet(s) and connected critical loads.

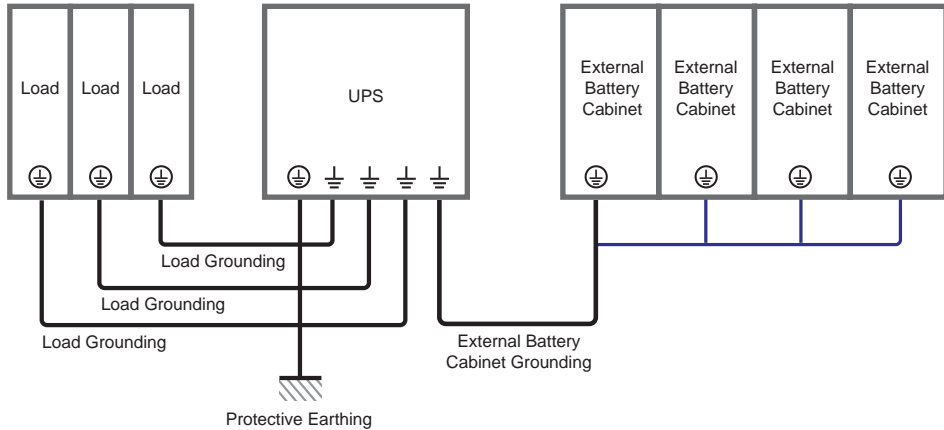

Figure 5-15: Grounding Diagram_ Single Unit

- **Dual Input (Single Unit)**

When there are two AC power sources, single unit wiring procedures are as follows.

- 1) Follow **5.5.2 Single Input/ Dual Input Modification** to modify the UPS from single input into dual input.
- 2) Follow the procedures 1) ~ 6) stated in the section of **Single Input (Single Unit)**.
- 3) Connect the main AC source/ bypass source/ external battery cabinet/ output's cables to the UPS. Please refer to **Figure 5-16 ~ Figure 5-17**.



NOTE:

The UPS will not work normally if the main AC power's and bypass power's neutral (N) is not firmly connected or not connected to the UPS's Input neutral (N).

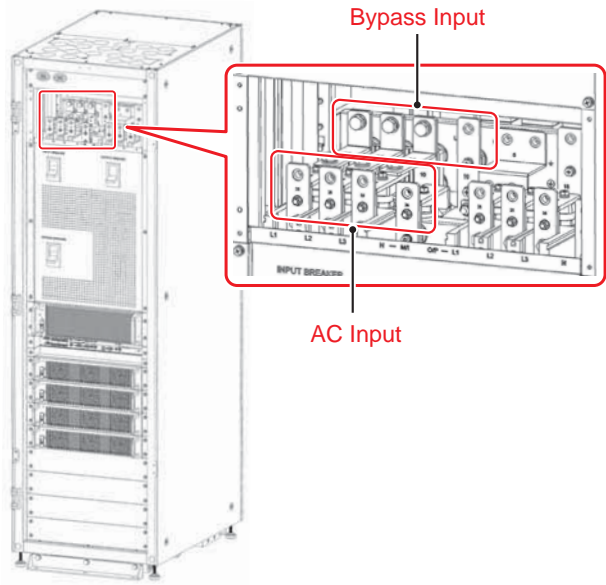

(Figure 5-16: Single Unit Dual Input Wiring_ AC Input & Bypass Input)

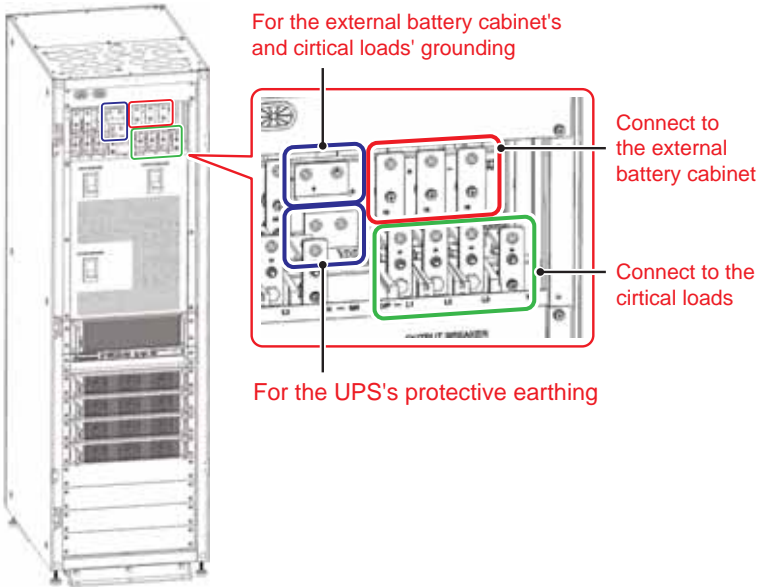

(Figure 5-17: Single Unit Dual Input Wiring_ UPS Output & Battery Input & Grounding)

- 4 Follow **Figure 5-15** to ground the UPS, external battery cabinet(s) and connected critical loads.

5.5.4 Parallel Unit Wiring



WARNING:

1. Only authorized Delta engineers or service personnel can perform installation, wiring, panel & cover removal, maintenance and operation. If you want to execute any action mentioned above by yourself, the action must be under the supervision of authorized Delta engineers or service personnel.
2. Up to four UPS units can be paralleled for redundancy and capacity expansion. If you would like to parallel more than two UPSs, please contact service personnel. Only the UPSs with the same capacity, voltage, frequency and version can be paralleled. For version information, please refer to **7.11.7 Version & S/N**. Please only use the provided parallel cable to parallel the UPS units. Otherwise, parallel functions will fail.
3. When the UPSs are paralleled, the length of each unit's bypass input cables plus output cables must be the same. This ensures that the parallel UPSs can equally share the critical loads in bypass mode.
4. The UPS's rating voltage is 120/ 208Vac or 127/ 220Vac; the external battery cabinet's rating voltage is ± 168 Vdc.
5. Before wiring, please read **5.5 Wiring** thoroughly and make sure relevant conditions have been met.

• Single Input (Parallel Units)

When there is only one AC power source, parallel units' wiring procedures are as follows.

- 1 Please follow the procedures 1 ~ 7 stated in the section of **Single Input (Single Unit)** to connect the cables of the main AC source, output and external battery cabinet(s) to each parallel UPS. For parallel connection, please refer to **Figure 5-18**. For battery connection, please refer to **5.6 External Battery Cabinet Connection Warning**.

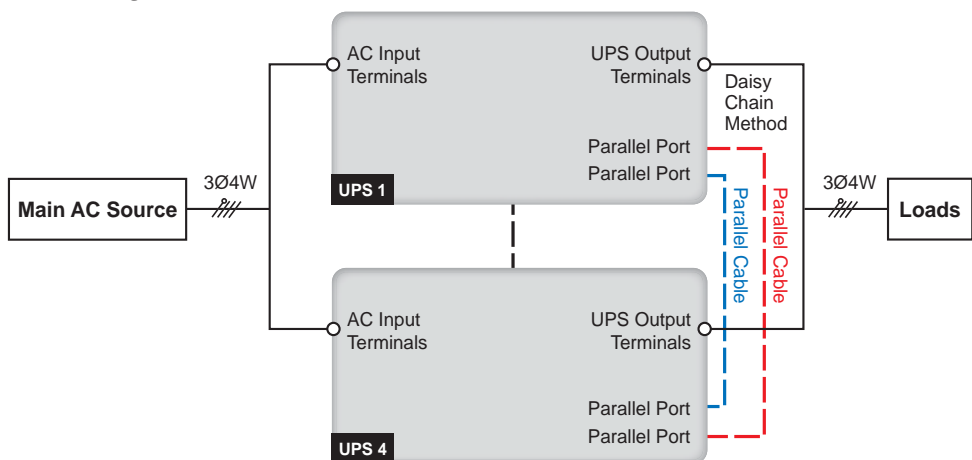

(Figure 5-18: Parallel Units Single Input Wiring Diagram)

**NOTE:**

For single input, the UPS will not work normally if the main AC power's neutral (N) is not firmly connected or not connected to the UPS's AC Input neutral (N) terminal.

- 2 Use the provided parallel cable to connect the parallel ports on the parallel units. Please refer to **Figure 4-3** for the parallel port location.
- 3 Follow **Figure 5-19** to ground the parallel UPS units, external battery cabinet(s) and connected critical loads.

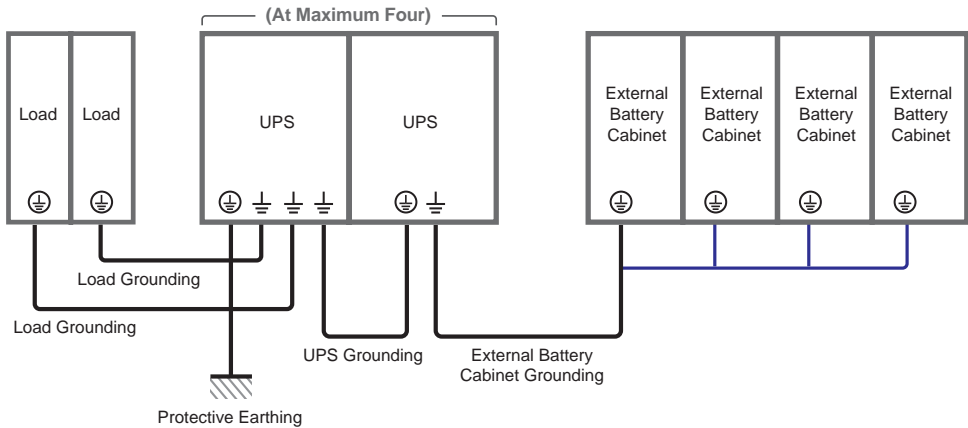

(Figure 5-19: Grounding Diagram_ Parallel Units)

**WARNING:**

Before start-up of the parallel units, qualified service personnel must set each UPS's '**Parallel Group ID**' and '**Parallel ID**' through the LCD. Otherwise, the parallel UPSs cannot be started. Please refer to **7.10.5 Parallel Setting**.

- **Dual Input (Parallel Units)**

When there are two AC power sources, parallel units wiring procedures are as follows.

- 1 Follow **5.5.2 Single Input/ Dual Input Modification** to modify the UPS from single input to dual input.
- 2 Refer to the procedures 1 ~ 3 stated in the section of **Dual Input (Single Unit)** to connect the cables of the main AC source, bypass source, output and external battery cabinet(s) to each parallel UPS. For parallel connection, please refer to **Figure 5-20**. For battery connection, please refer to **5.6 External Battery Cabinet Connection Warning**.

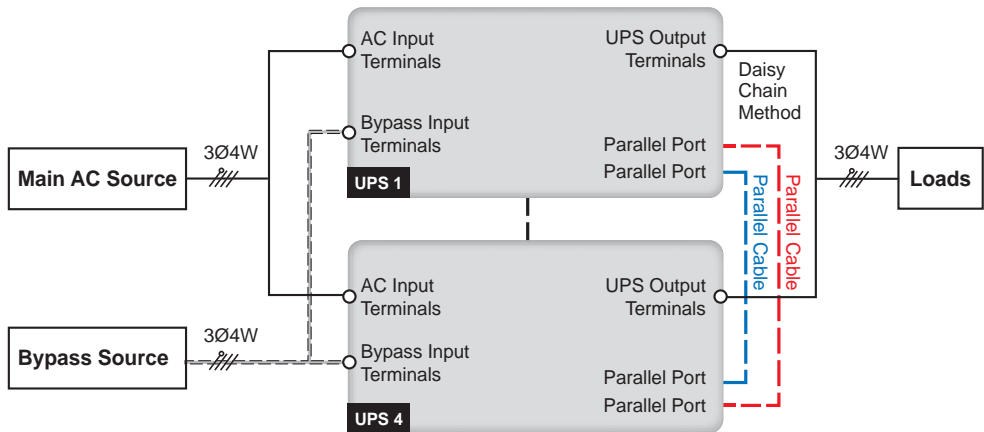

(Figure 5-20: Parallel Units Dual Input Wiring Diagram)



NOTE:

For dual input, the UPS will not work normally if the main AC power's neutral (N) and the bypass power's neutral (N) are not firmly connected or not connected to the UPS's AC Input neutral (N) terminal and Bypass Input neutral (N) terminal respectively.

- 3 Use the provided parallel cable to connect the parallel ports on the parallel units. Please refer to **Figure 4-3** for the parallel port location.
- 4 Follow **Figure 5-19** to ground the parallel UPS units, external battery cabinet(s) and connected critical loads.



WARNING:

Before start-up of the parallel units, qualified service personnel must set each UPS's '**Parallel Group ID**' and '**Parallel ID**' through the LCD. Otherwise, the parallel UPSs cannot be started. Please refer to **7.10.5 Parallel Setting**.

5.6 External Battery Cabinet Connection Warnings



NOTE:

The information stated in **5.6 External Battery Cabinet Connection Warnings** is only applicable to the lead-acid batteries. Please contact Delta service personnel for any battery/ battery cabinet's setup and configurations.

- You should connect the UPS with at least one external battery cabinet to ensure that the connected critical loads are protected when a power failure occurs. You can connect up to four units of external battery cabinets to the UPS.

- To ensure that the batteries are fully charged, please charge the batteries at least 12 hours before the first use of the UPS. The charging procedures are as follows:

- ① Connect the UPS to the main AC source and the external battery cabinet(s). Please see **5. Installation and Wiring**.
- ② Follow **6. UPS Operation** to turn on the UPS and the external battery cabinet(s). After the UPS is turned on, the UPS will automatically charge the batteries.



WARNING:

You can connect the critical loads to the UPS only after the batteries are fully charged. This guarantees that the UPS can provide sufficient backup power to the critical loads connected when a power failure occurs.

• **Battery Parameters**

No.	Item	Description
1	Charge Voltage	Float charge voltage: $\pm 190\text{Vdc}$ (default)
		Equalized charge voltage: $\pm 196\text{Vdc}$ (default)
2	Charge Current	Default: $\pm 10\text{A}$ (UPS)
		Maximum: $\pm 6\text{A}$ (per power module)
3	Low Battery Shutdown Voltage	$\pm 140\text{Vdc}$ (default)
4	The Number of Batteries	12V x 28 PCS



NOTE:

1. You can adjust the charge current. Each adjustment level is 1 A.
 2. If you need to modify the default charge current setting and default low battery shutdown setting, please contact your local dealer or service personnel.
 3. For battery selection, installation and replacement, please contact your local dealer or customer service.
 4. The number of batteries that you set up via the LCD must be the same as that of the on-site installation; otherwise, the batteries will be over charged, not fully charged or even seriously damaged.
- Only use the same type of batteries from the same supplier. Never use old, new and different Ah batteries at the same time.
 - The number of batteries must meet UPS requirements.
 - Do not connect the batteries in reverse.

- Use a voltage meter to measure whether the total voltage, after the external battery cabinet connection, is around 12.5Vdc x the total number of batteries.
- The number of batteries is 28 PCS of 12V batteries connected in string, and you should connect the external battery cabinet's neutral to the middle 14th and 15st batteries. You should use battery cables to connect the external battery cabinet with the '+', '-' and 'N' terminals marked on the UPS. Please refer to **Figure 5-21**.

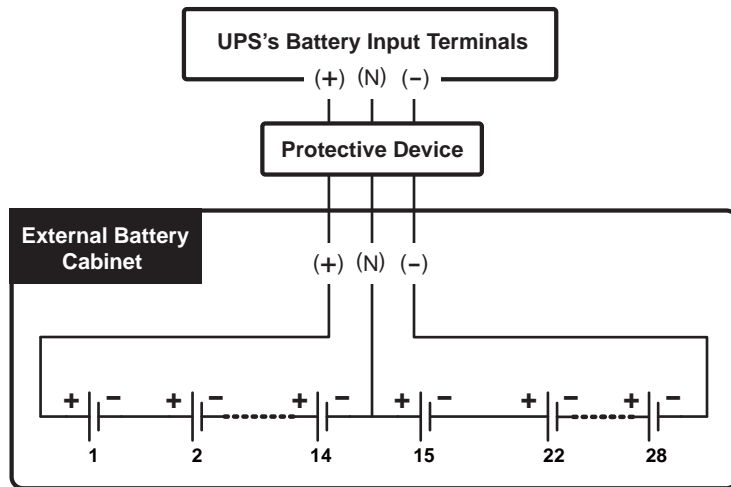

(Figure 5-21: External Battery Cabinet Connection)



WARNING:

A battery leak can short-circuit the batteries and lead to serious accidents. For safety's sake, you must insulate the batteries from their touched metal cabinets by installing insulated devices (e.g. insulated trays or boxes) in between. For relevant information about the insulated materials for such application, please contact Delta customer service.

- Please follow your UPS rating to install an appropriate protective device for each external battery cabinet. There are two installation methods for selection.
 - (1) A 3-pole DC isolated switch connected in series with a DC fuse.
 - (2) A 3-pole DC circuit breaker.

For relevant values, please refer to **Table 5-4**; for relevant installation diagrams, please refer to **Figure 5-22 ~ Figure 5-23**.

Table 5-4: External Battery Cabinet's Protective Device (Battery Q'ty: 12Vdc x 28 PCS)

UPS Rating	Power Module Q'ty	Protective Device's Current	Protective Device's Voltage
15kVA/ 15kW	1+1	60A	1. DC fuse \geq 250Vdc 2. 3-pole DC circuit breaker (per pole voltage \geq 250Vdc)
30kVA/ 30kW	2+1	125A	
45kVA/ 45kW	3+1	175A	
60kVA/ 60kW	4+1	250A	
75kVA/ 75kW	5+1	300A	
90kVA/ 90kW	6+1	350A	
105kVA/105kW	7+1	400A	

**NOTE:**

1. **Table 5-4** is for 12Vdc x 28PCS batteries.
 2. The above-mentioned DC circuit breaker, DC isolated switch and DC fuse are optional. If you want to buy any of them, please contact Delta service personnel.
 3. If you need to parallel multiple units of external battery cabinets, please contact Delta service personnel for relevant information.
 4. To extend backup time, you can parallel up to four units of external battery cabinets to the UPS. Please note that (1) the number of batteries in each of the parallel external battery cabinets and (2) the cable length of each string of the batteries must be the same.
- Please note that only authorized Delta engineers or service personnel can perform wiring or you can perform wiring only under the supervision of authorized Delta engineers or service personnel.
 - For the external battery cabinet's grounding information, please refer to:
 - Figure 5-15: Grounding Diagram_ Single Unit**
 - Figure 5-19: Grounding Diagram_ Parallel Units**
 - The external battery cabinet's protective device must be planned and designed by qualified service personnel. The protective device should be either an isolated switch connected in series with a DC fuse or a DC circuit breaker; please refer to **Table 5-4**. When choosing the external battery cabinet's protective device, please take the following factors into consideration: (1) overcurrent between the UPS and battery circuit, (2) short circuit, (3) wire/ cable materials, and (4) local electrical regulations. If you have any questions about the external battery cabinet's protective device, please contact Delta service personnel. For installation methods of the external battery cabinet's protective device, please refer to **Figure 5-22 ~ Figure 5-23**.

- The protective device is optional, and its type must be fast-acting DC circuit breaker or/ and fast-acting DC fuse. When choosing the protective device, please follow the instructions below.
 - (1) The protective device's rated current must comply with the current values shown in **Table 5-4**.
 - (2) The specifications of the protective device's short-circuit protection (i.e. the tripping current of the fast-acting DC circuit breaker or/ and the melting current of the fast-acting DC fuse) must be 3 ~ 6 times the values shown in **Table 5-4**. Besides, the response time of the protective device must be less than 20ms.
 - (3) For the choice of the fast-acting DC fuse mentioned above, the A50QS series from the supplier **Ferraz Shawmut** is suggested. Please contact Delta customer service for relevant information.
 - (4) The maximum tripping current of the fast-acting DC circuit breaker or/ and the maximum melting current of the fast-acting DC fuse mentioned above are 6 times the values shown in **Table 5-4**. These maximum values are suggested for general applications only. For actual maximum values, the maximum short-circuit capacity of the on-site batteries must be taken into consideration. Please contact Delta customer service for relevant information.
- The external battery cabinet's protective device installation methods are as follows.

Option 1: An isolated switch connected in series with a DC fuse (voltage $\geq 250\text{Vdc}$)

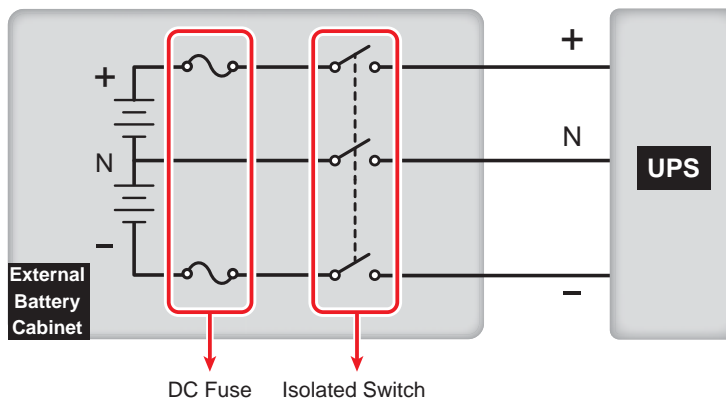

(Figure 5-22: Installation of an Isolated Switch Connected in Series with a DC Fuse)

Option 2: A 3-pole DC circuit breaker (per pole voltage $\geq 250\text{Vdc}$)

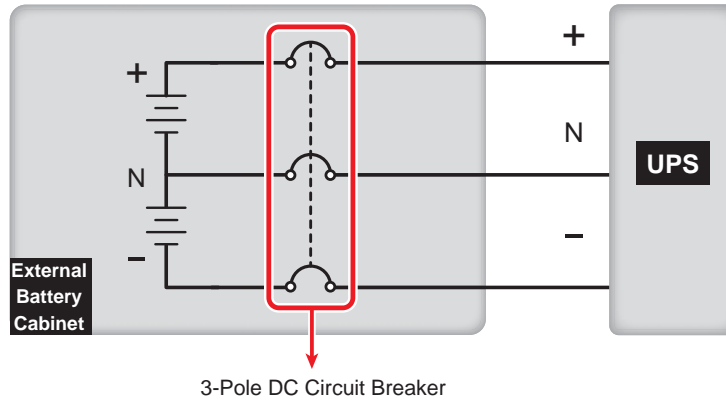

(Figure 5-23: Installation of a 3-Pole DC Circuit Breaker)

- To save on your costs and installation space, the parallel UPSs (at maximum four units) can share their connected external battery cabinet(s). For relevant information, please refer to **3.4 Common Battery (Only for Parallel UPSs Connecting to the Same External Battery Cabinet(s))**.



WARNING:

- Before performing battery/ battery cabinet replacement, please turn off the external battery cabinet's breaker (Q5) to isolate the battery power from the UPS completely.
- A battery can present a risk of electric shock and high short-circuit current. Servicing of batteries and battery cabinets must be performed or supervised by qualified service personnel knowledgeable in batteries, battery cabinets and the required precautions. Keep unauthorized personnel away from batteries and battery cabinets.

- External Battery Cabinet Alarm**

When any external battery cabinet connected to the UPS has the following problems, the UPS system will sound an alarm. Please see the table below.

No.	External Battery Cabinet Status	Alarm
1	Battery Abnormal - Reversed	Sounds 50ms every second.
2	Battery Ground Fault	Sounds 50ms every second.
3	Battery Over Temperature	Sounds 50ms every second.
4	Battery Under Temperature	Sounds 50ms every second.

No.	External Battery Cabinet Status	Alarm
5	Battery Breaker Off	Sounds 50ms every 3 seconds.
6	Battery Disconnected (Missing)	Sounds once every second.
7	Battery Over Charged	Long beep.
8	Battery Test Fail	Sounds 50ms every second.
9	Battery End of Discharge Imminent	Sounds 50ms every second.
10	Battery End of Discharge	Long beep.
11	Battery Life Time Expired	Sounds 50ms every 3 seconds.

5.7 STS Module

The hot swappable STS module has been installed inside the UPS in the Delta factory before shipment. Please see **Figure 5-24** for its location.

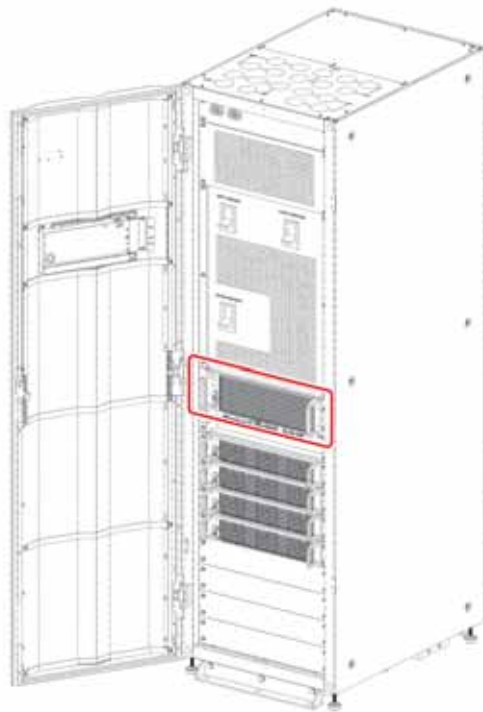

(Figure 5-24: STS Module Location)

For STS module illustration, please refer to **Figure 5-25**.

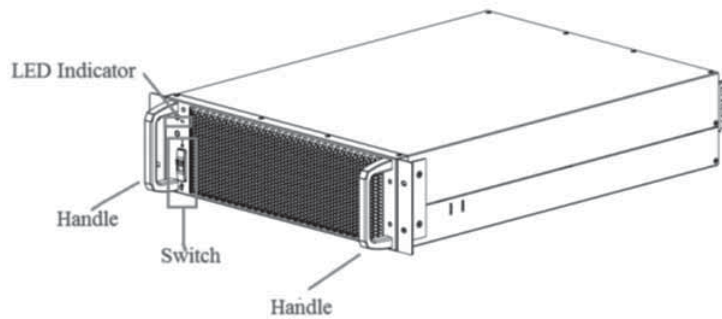

(Figure 5-25: STS Module)

5.7.1 STS Module Installation

The hot swappable STS module has been installed inside the UPS in the Delta factory before shipment. If the STS module is removed for some reasons and you want to re-install it, please follow the steps below:



NOTE:

1. Only qualified service personnel can perform the following STS module installation procedures.
2. The STS module is heavy (> 55.1 lb (25 kg)). At least two people are required for handling.

- ① Confirm that the STS module's switch is in the lower position ().

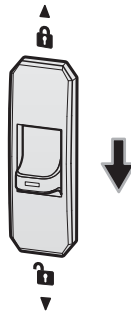

(Figure 5-26: Confirm the STS Module's Switch in the Lower Position)

- 2 Insert the STS module into the unoccupied STS module slot until it snaps into place. At least two people are required for handling.

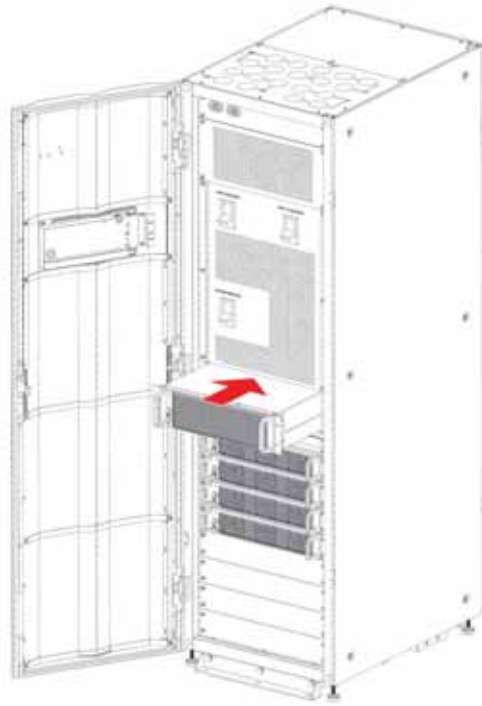

(Figure 5-27: Insert the STS Module into the UPS)

- 3 Re-install the four screws (removed during the STS module removal process) to firmly fix the STS module's ear brackets on the UPS cabinet.

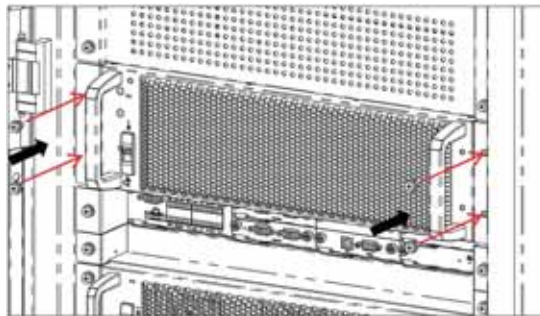

(Figure 5-28: Fix the STS Module on the UPS)

- 4 Turn the STS module's switch to the upper position ().

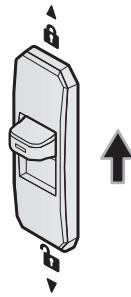

(Figure 5-29: Turn the STS Module's Switch to the Upper Position)

5.7.2 STS Module Removal



NOTE:

1. Only qualified service personnel can perform the following STS module removal procedures.
2. The STS module is heavy (> 55.1 lb (25 kg)). At least two people are required for handling.

- 1 Turn the STS module's switch to the lower position () and wait until the STS module's LED indicator becomes off.

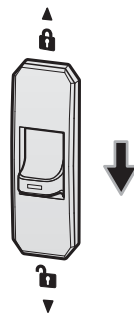

(Figure 5-30: Turn the STS Module's Switch to the Lower Position)

- 2 Unscrew the four screws shown in **Figure 5-31**.

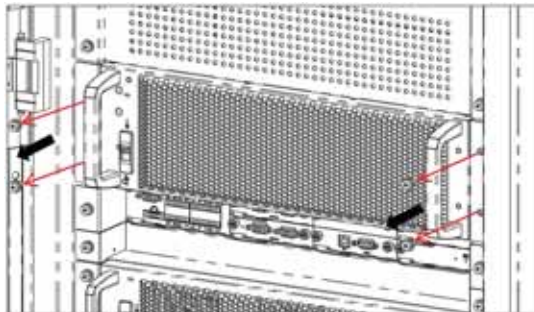

(Figure 5-31: Remove the Four Screws)

- 3 Pull out the STS module from the slot (two people are required) (see **Figure 5-32**). When the STS module cannot be pulled out any more, press the lock (see **Figure 5-33**) on the left side of the STS module in order to continuously pull out the module from the UPS cabinet.

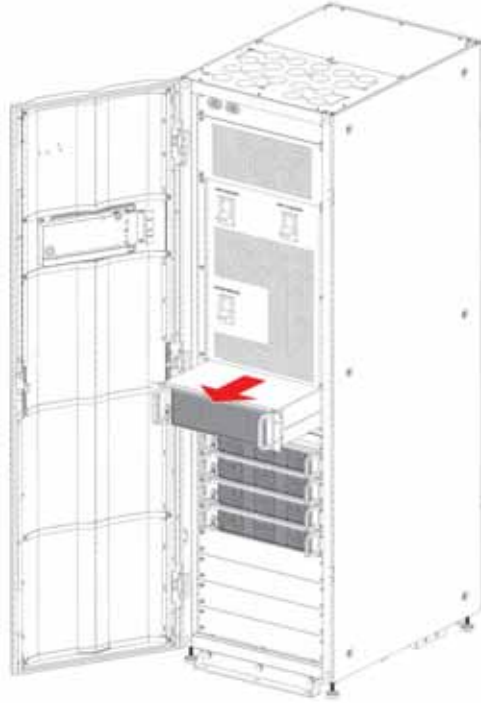

(Figure 5-32: Remove the STS Module)

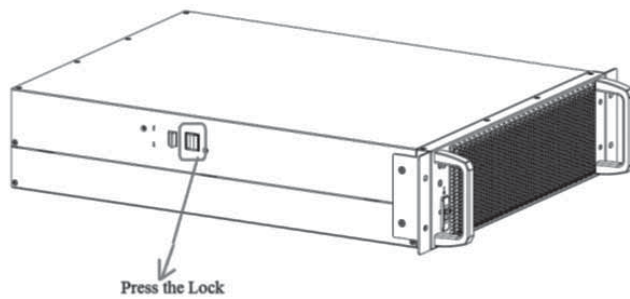

(Figure 5-33: Press the Lock of the STS Module)

5.7.3 STS Module's LED Indicator

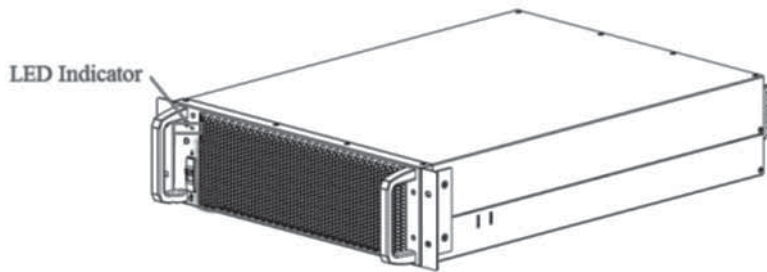

(Figure 5-34: STS Module's LED Indicator)

The STS module's LED indicator shows its operation status. Please refer to the following table.

LED Indicator	Description
OFF	The STS module is OFF.
ON (yellow)	The STS module is working in bypass mode, ECO mode, or energy recycle mode.
Flashing (yellow)_ on for 0.3 second and off for 3 seconds	The STS module is abnormal.



NOTE:

In bypass mode, if you turn the STS module's switch to the lower position (), the STS module will shut down, and its output and LED indicator will be off.

5.8 Power Module (Optional)

The power module is optional (not included in the package of the UPS). It is hot swappable and each capacity is 15kVA/ 15kW. Please follow your UPS capacity to install the correct number of power modules. Please note that the power module Q'ty is designed as N + 1 redundancy. Please refer to the table below.

UPS Capacity	15kVA/ 15kW	30kVA/ 30kW	45kVA/ 45kW	60kVA/ 60kW	75kVA/ 75kW	90kVA/ 90kW	105kVA/ 105kW
Power Module Q'ty	1 + 1	2 + 1	3 + 1	4 + 1	5 + 1	6 + 1	7 + 1

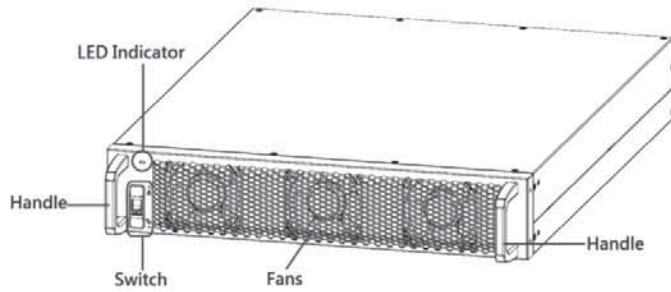

(Figure 5-35: Power Module (Optional))

Please see the table below for the power module's packing list.

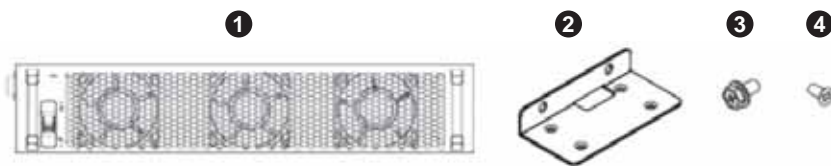

Table 5-5: Power Module Package List

No.	Item	Q'ty
①	Power Module	1 PC
②	Ear Bracket	2 PCS
③	M6 Screw	4 PCS
④	M4 Screw	8 PCS

5.8.1 Power Module Installation

After firmly fixing the UPS on the designated installation area according to the instructions stated in **5.4 Fixing the UPS**, continue with the following steps to install the power module (optional) into the UPS.

**WARNING:**

1. Only qualified service personnel can perform the following power module installation procedures.
2. The power module is heavy (around 45.6 lb (20.7 kg)).
3. Please follow your UPS capacity to install the correct number of power modules. Please refer to the table below.

UPS Capacity	15kVA/ 15kW	30kVA/ 30kW	45kVA/ 45kW	60kVA/ 60kW	75kVA/ 75kW	90kVA/ 90kW	105kVA/ 105kW
Power Module Q'ty	1 + 1	2 + 1	3 + 1	4 + 1	5 + 1	6 + 1	7 + 1

- 1) Confirm that the power module's switch is in the lower position ().

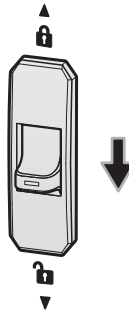

(Figure 5-36: Confirm the Power Module's Switch in the Lower Position)

- 2) Take out the two ear brackets, four M6 screws and eight M4 screws from the power module's package.
- 3) Use the provided eight M4 screws to fix the provided two ear brackets on the two sides of the power module. Please refer to **Figure 5-37**.

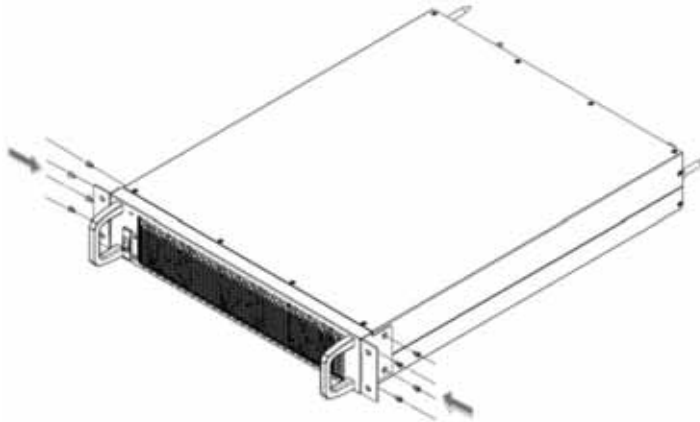

(Figure 5-37: Install the Two Ear Brackets)

- 4 Insert the power module into the unoccupied power module slot until it snaps into place. Please install the power modules into the slots from top to bottom in sequence.

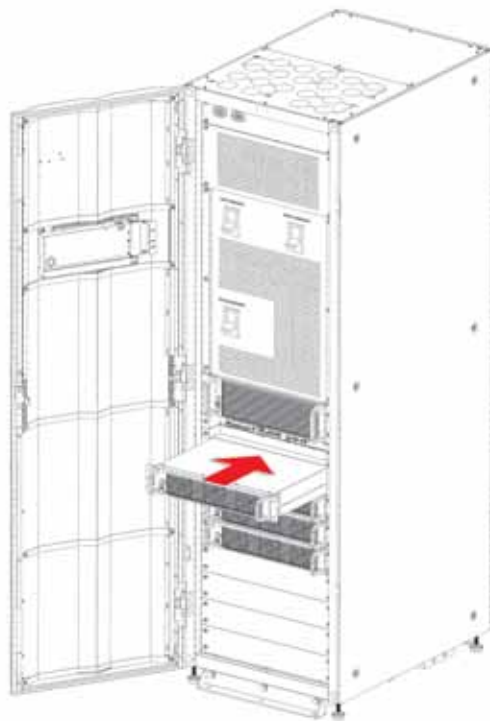

(Figure 5-38: Insert the Power Module into the UPS)

- 5 Use the provided four M6 screws to firmly fix the power module on the UPS.

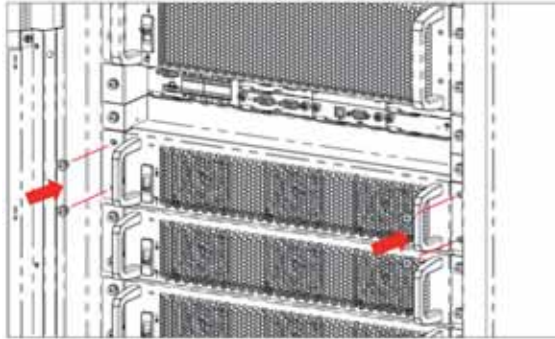

(Figure 5-39: Fix the Power Module on the UPS)

- 6 Turn the power module's switch to the upper position ().

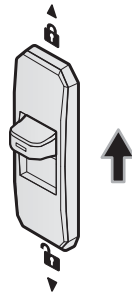

(Figure 5-40: Turn the Power Module's Switch to the Upper Position)

5.8.2 Power Module Removal



WARNING:

1. Before removing any power module, make sure the remaining power module(s) can support the connected critical loads.
2. Only qualified service personnel can perform the following power module removal procedures.
3. The power module is heavy (around 45.6 lb (20.7 kg)).

- 1 Turn the power module's switch to the lower position (). After that, the power module will start discharging. After discharging, the power module's LED indicator will be off.

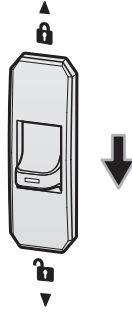

(Figure 5-41: Turn the Power Module's Switch to the Lower Position)

- 2 Use a screwdriver to remove the four screws from the power module, as shown in **Figure 5-42**.

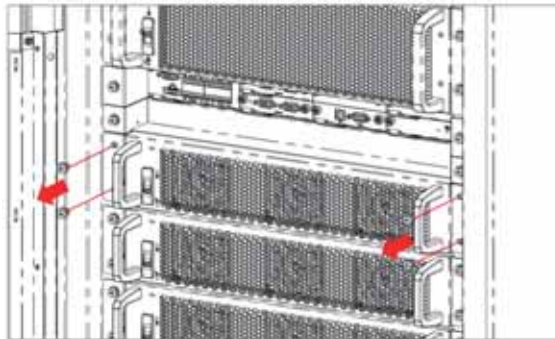

(Figure 5-42: Remove the Four Screws)

- 3 Pull out the power module from the slot (see **Figure 5-43**). When the power module cannot be pulled out any more, press the lock (see **Figure 5-44**) on the left side of the power module to continuously pull it out from the UPS cabinet.

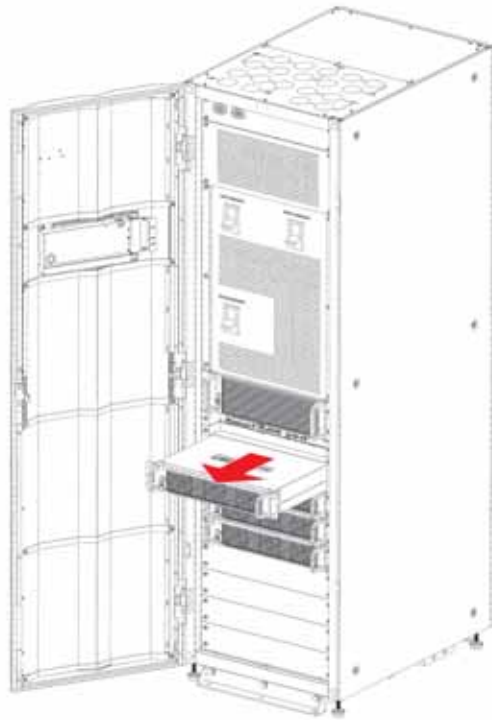

(Figure 5-43: Remove the Power Module)

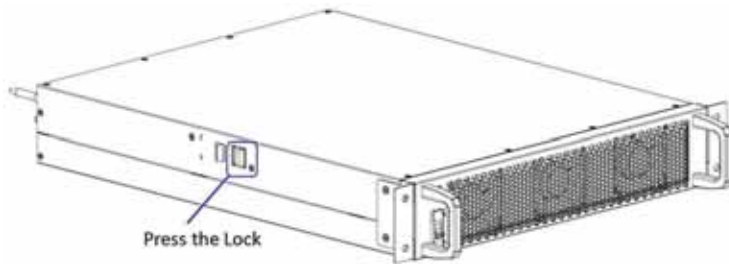

(Figure 5-44: Press the Lock of the Power Module)

5.8.3 Power Module's LED Indicator

The power module's LED indicator shows its operation status. Please refer to the following table.

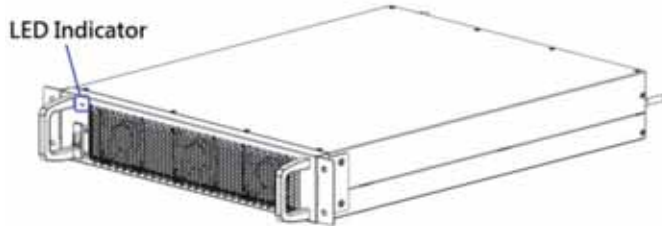

(Figure 5-45: Power Module's LED Indicator)

LED Indicator	Description
OFF	The power module is OFF.
ON (green)	<ol style="list-style-type: none"> 1. The power module is running in online mode or in battery mode. 2. The power module's inverter starts up. 3. The power module's PFC starts up.
Flashing (green)_ on for 2 seconds and off for 1 second	The power module is under discharging process.
Flashing (green)_ on for 0.3 second and off for 3 seconds	The power module is abnormal.



NOTE:

In online mode, if you turn the power module's switch to the lower position (), the power module will shut down its output and discharge the DC BUS voltage until the voltage reaches to a safety level. After that, the power module's LED indicator will be off.

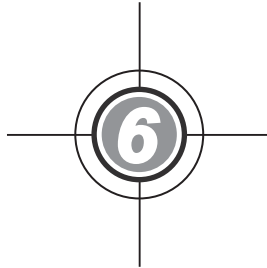

UPS Operation

- 6.1 Pre Start-up & Pre Turn-off Warnings for Single Unit and Parallel Units
- 6.2 Start-up Procedures
- 6.3 Turn-off Procedures



6.1 Pre Start-up & Pre Turn-off Warnings for Single Unit and Parallel Units



NOTE:

1. All unit No., UPS status, date, time, warning No., event No., load (%), battery remaining time, user login, administrator login, etc. shown in the LCD diagrams presented in **6. UPS Operation** are for reference only. Actual readings depend on the operation of the UPS.
2. In this user manual, the meaning of Q1, Q2, Q3, Q4 and Q5 represents the following.

Code	Meaning
Q1	Input Breaker
Q2	Bypass Breaker
Q3	External Manual Bypass Breaker
Q4	Output Breaker
Q5	External Battery Cabinet's Breaker

3. Before operation, ensure that installation and wiring have been completely done according to **5. Installation and Wiring**, and relevant instructions have been followed.
4. Before operation, please refer to **2.8 Tri-color LED Indicator & Buzzer** and **7. LCD Display & Settings**.
5. (1) The setting of the **On/ Off Button Access** is set as 'Any User' for all the **ON/ OFF Button** () presented in this user manual.
(2) If you want to change the access setting for the **ON/ OFF Button** (), please go to  → **General Setting** → **User** → **On/ OFF Button Access**. For relevant information, please refer to **7.10.7 General Setting**.

Single Unit

• Pre Start-up Warnings for Single Unit

1. Make sure that all the breakers, including every external battery cabinet's breaker (Q5), are turned to the **OFF** position.
2. Make sure that the UPS's voltage difference between the Neutral (N) and Ground () is < 3V.



3. Check if the wiring is correct. Ensure that the AC power's voltage, frequency, phase sequence and battery type meet the UPS's requirements.
4. Check if all power modules are properly installed and every power module's switch is in the upper position (). Please refer to **5.8 Power Module (Optional)** for more information.

- **Pre Turn-off Warnings for Single Unit**

If you perform turn-off procedures for single unit, all power will be completely cut off. Please make sure the critical loads connected to the UPS have already been safely shut down before you perform the turn-off procedures.

Parallel Units

- **Pre Start-up Warnings for Parallel Units**

1. You can parallel at maximum four UPS units.
2. For parallel units, ensure that each parallel cable (provided) is connected well.
3. Make sure that all the breakers, including every external battery cabinet's breaker (Q5), are turned to the **OFF** position.
4. Make sure that each parallel UPS's voltage difference between the Neutral (N) and Ground () is < 3V.
5. Check if the wiring is correct. Ensure that the AC power's voltage, frequency, phase sequence and battery type meet the UPS's requirements.
6. Check if all power modules are properly installed and every power module's switch is in the upper position (). Please refer to **5.8 Power Module (Optional)** for more information.
7. For parallel units, ensure that every operation procedure is synchronized to all parallel UPSs.
8. For parallel application, if you just want to operate a specific UPS but not all parallel ones, please contact service personnel.

- **Pre Turn-off Warnings for Parallel Units**

1. If you want to turn off one of the parallel UPSs, please check whether the remaining parallel units' total capacity exceeds the total critical loads. If the remaining parallel units' total capacity is less than the total critical loads, all parallel units will shut down due to overload.
2. If you perform turn-off procedures for all parallel UPSs, all power will be completely cut off. Please make sure that the critical loads connected to the parallel UPSs have already been safely shut down before you perform the turn-off procedures.

6.2 Start-up Procedures

6.2.1 On-Line Mode Start-up Procedures



WARNING:

1. For parallel units, please follow **6.2.3 Bypass Mode Start-up Procedures** to turn on each parallel UPS. After confirming that parallel operation works normally, follow the procedures below step by step.
2. For parallel units, ensure that every operation procedure mentioned below is synchronized to all parallel UPSs.
3. For parallel application, if you just want to operate a specific UPS but not all parallel ones, please contact service personnel.

- ① Ensure that the External Manual Bypass Breaker (Q3) is in the **OFF** position.
- ② Switch **ON** every external battery cabinet's breaker (Q5).
- ③ Switch **ON** the Bypass Breaker (Q2) and wait for the LCD initial screen (see **Figure 6-1**). After that, turn **ON** the Input Breaker (Q1) and Output Breaker (Q4).



(Figure 6-1: LCD Initial Screen)

- ④ After you switch **ON** the Input Breaker (Q1) and Bypass Breaker (Q2), each auxiliary power card's LED indicator will illuminate green and the following status will occur simultaneously.
 - (1) The system and each power module will start initialization. After each power module finishes initialization, each power module's fans will start running, each power module will start establishing DC BUS voltage and each power module's LED indicator will illuminate green.

- (2) Each parallel communication card's LED indicator will illuminate red first and then each card will start initialization. After initialization, the master parallel communication card's LED indicator will illuminate green and the backup communication card's LED indicator will illuminate yellow.

For the locations of the parallel communication cards, auxiliary power cards, power modules and their LED indicators, please refer to **Figure 6-2**.

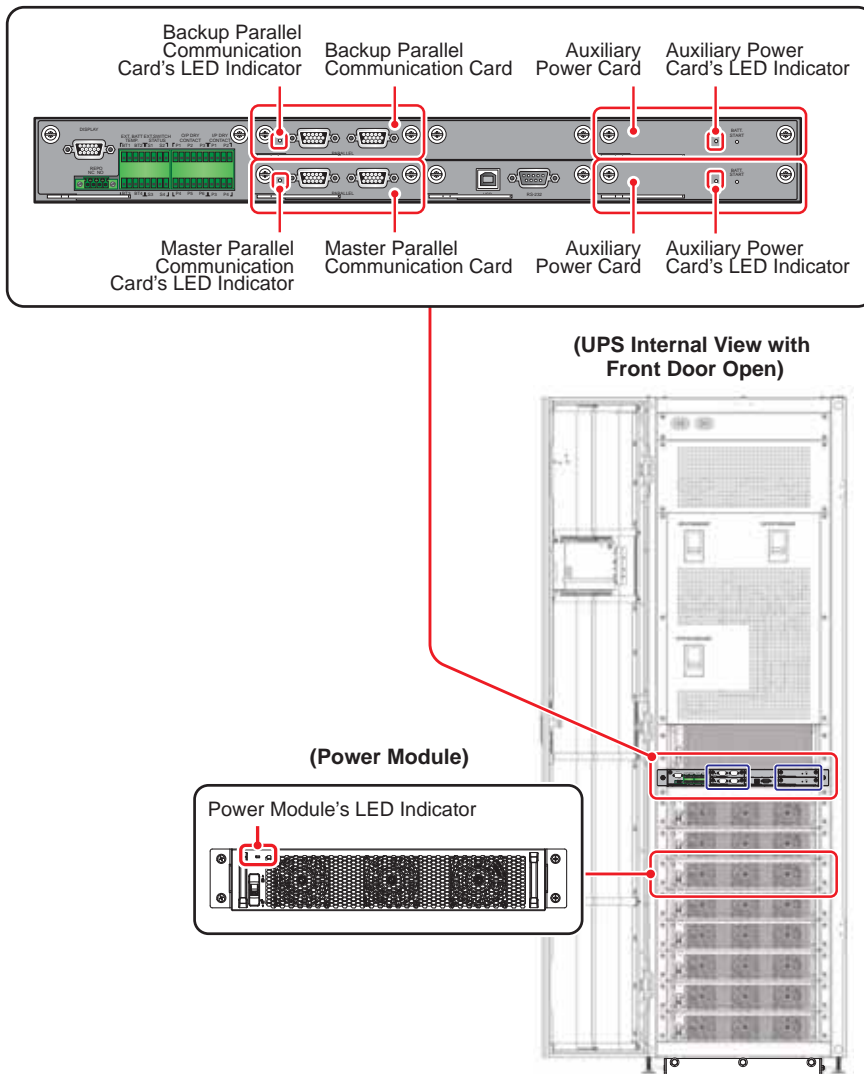

(Figure 6-2: The Locations of the Parallel Communication Cards, Auxiliary Power Cards, Power Modules and their LED Indicators)

- 5 After 20 seconds of LCD initialization, the LCD will enter the **Main Screen**. For the **Main Screen** information, please refer to **7.6 Main Screen**.

Now, each power module keeps running and its LED indicator remains green. After each power module finishes establishing DC BUS voltage, the charger will start to charge the batteries.

If the bypass AC source is within the normal range, the UPS will transfer to run in Bypass mode, the LCD screen will show as **Figure 6-3** and the tri-color LED indicator will illuminate yellow. For the location of the tri-color LED indicator, please refer to **Figure 2-11**.

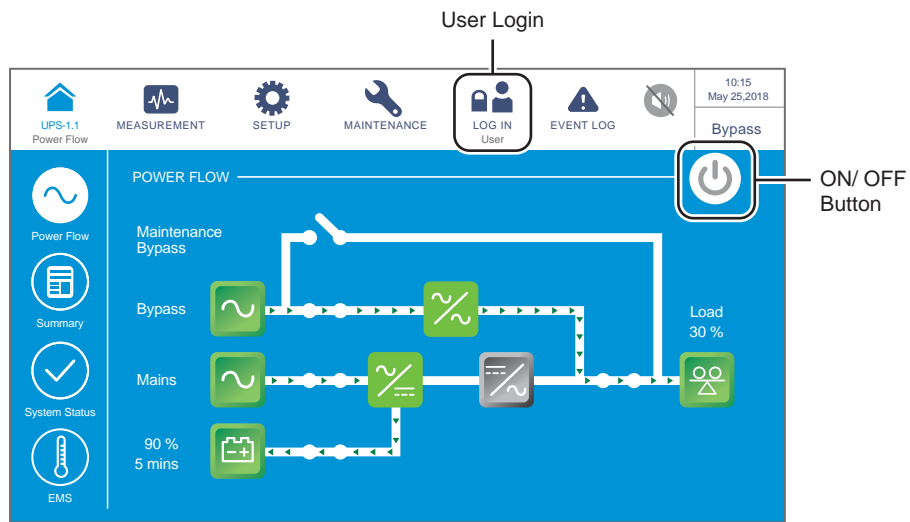

(Figure 6-3: Main Screen, User Login & ON/ OFF Button Location)

- 6 Tap the ON/ OFF Button (⏻) and the following screen will pop up to ask if you want to power on the UPS's inverter. Please select 'YES'.

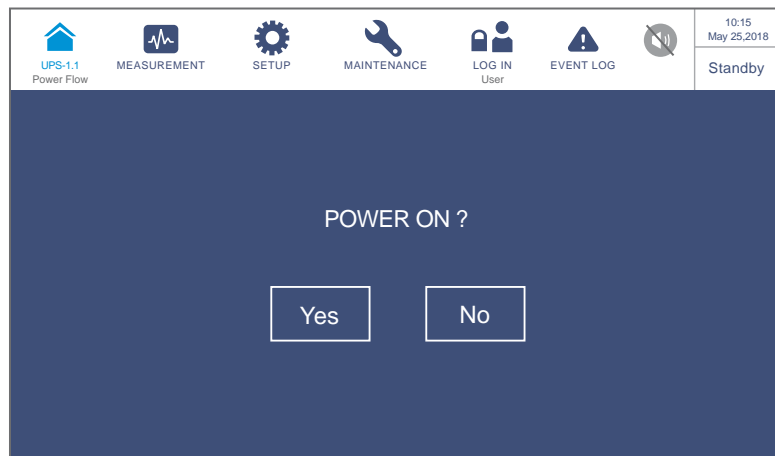

(Figure 6-4: Power on Reminder Screen)

- 7 After selection of 'YES' to start up the UPS's inverter, each power module will start up and perform self-inspection. At the same time, the system begins synchronization with the bypass AC source. After the self-inspection is completed, the UPS will automatically transfer to run in On-Line mode, the tri-color LED indicator will illuminate green and the following screen will appear. For the location of the tri-color LED indicator, please refer to **Figure 2-11**.

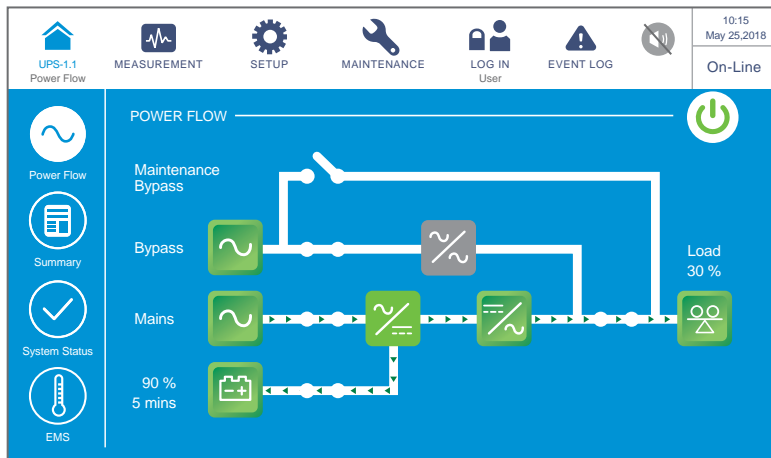

(Figure 6-5: On-Line Mode Screen)

6.2.2 Battery Mode Start-up Procedures



WARNING:

1. For parallel units, please follow **6.2.3 Bypass Mode Start-up Procedures** to turn on each parallel UPS. After confirming that parallel operation works normally, follow the procedures below step by step.
2. For parallel units, ensure that every operation procedure mentioned below is synchronized to all parallel UPSs.
3. For parallel application, if you just want to operate a specific UPS but not all parallel ones, please contact service personnel.

- 1 Ensure that the External Manual Bypass Breaker (Q3) is in the **OFF** position.
- 2 Switch **ON** every external battery cabinet's breaker (Q5).
- 3 Switch **ON** the Output Breaker (Q4).
- 4 Press any of the **BATT. START** buttons (see **Figure 7-2**) for one second and release it. After that, each auxiliary power card's LED indicator will illuminate green and the following status will occur simultaneously.
 - (1) The system and each power module will start initialization. After each power module finishes initialization, each power module's fans will start running.

- (2) Each parallel communication card's LED indicator will illuminate red first and then each card will start initialization. After initialization, the master parallel communication card's LED indicator will illuminate green and the backup communication card's LED indicator will illuminate yellow.

For the locations of the parallel communication cards, auxiliary power cards, power modules and their LED indicators, please refer to **Figure 6-2**.

- 5 The LCD initial screen (see **Figure 6-6**) will appear within 40 seconds after each auxiliary power card's LED indicator illuminates green.



(Figure 6-6: LCD Initial Screen)

- 6 After 20 seconds of LCD initialization, the LCD will enter the **Main Screen** shown in **Figure 6-7** and the tri-color LED indicator will illuminate yellow. For the location of the tri-color LED indicator, please refer to **Figure 2-11**.

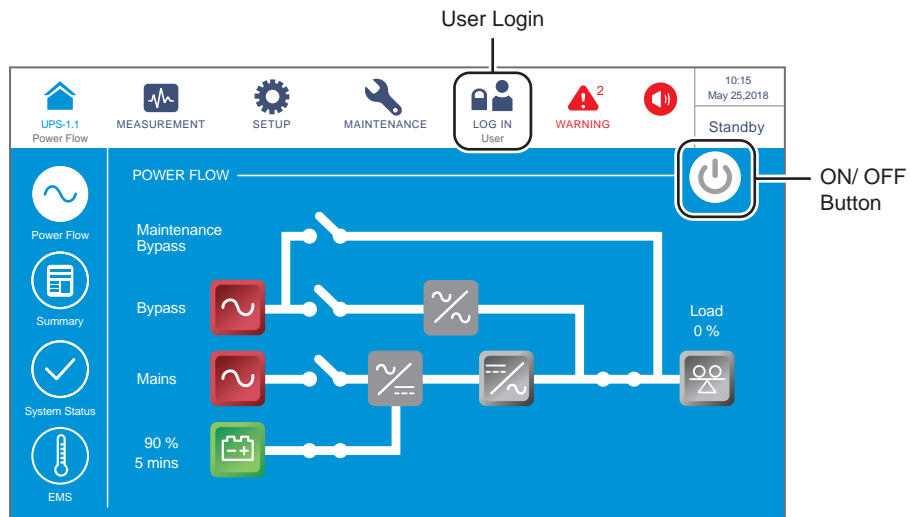

(Figure 6-7: Main Screen_ User Login & ON/ OFF Button Location)

- 7 Tap the ON/ OFF Button () and the following screen will pop up to ask if you want to power on the UPS. Please select 'YES'.

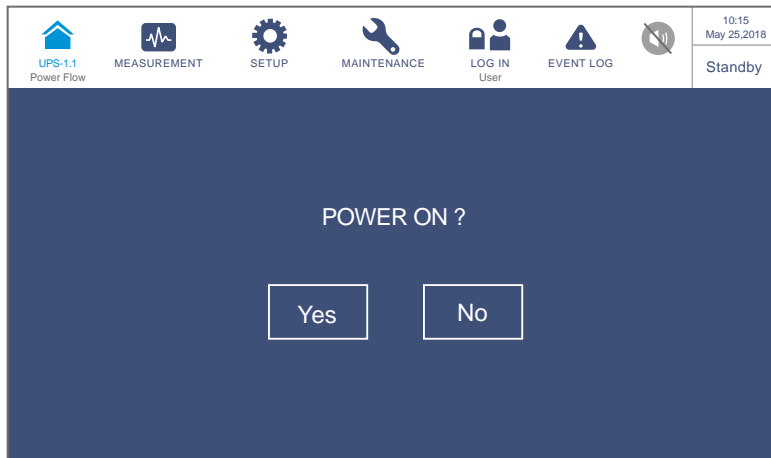

(Figure 6-8: Power on Reminder Screen)

- 8 After selection of 'YES' to start up the UPS's inverter, each power module will start up, each power module's LED indicator will illuminate green and each power module will perform self-inspection. After the self-inspection is completed, the UPS will automatically transfer to run in Battery mode. At this moment, the tri-color LED indicator illuminates yellow and the following screen appears. For the tri-color LED indicator location, please refer to **Figure 2-11**.

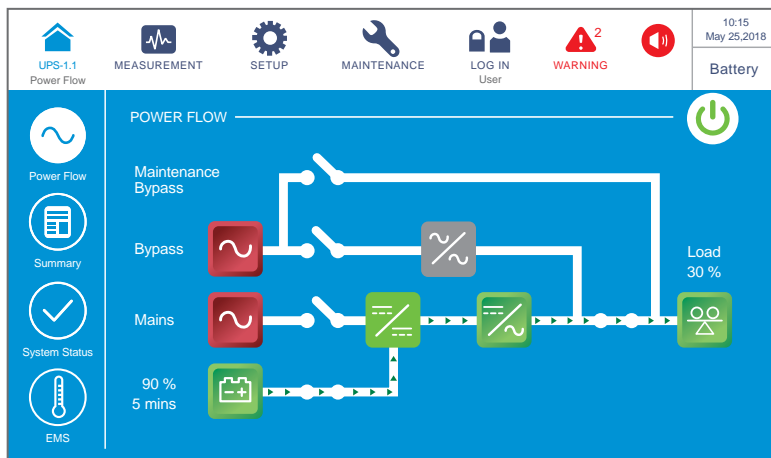

(Figure 6-9: Battery Mode Screen)

6.2.3 Bypass Mode Start-up Procedures



WARNING:

1. For parallel units, ensure that every operation procedure mentioned below is synchronized to all parallel UPSs.
2. For parallel application, if you just want to operate a specific UPS but not all parallel ones, please contact service personnel.

- 1 Ensure that the External Manual Bypass Breaker (Q3) is in the **OFF** position.
- 2 Switch **ON** every external battery cabinet's breaker (Q5).
- 3 Switch **ON** the Bypass Breaker (Q2) and wait for the LCD initial screen (see **Figure 6-10**). After that, turn **ON** the Input Breaker (Q1).



(Figure 6-10: LCD Initial Screen)

- 4 After you switch **ON** the Input Breaker (Q1) and Bypass Breaker (Q2), each auxiliary power card's LED indicator will illuminate green and the following status will occur simultaneously.
 - (1) The system and each power module will start initialization. After each power module finishes initialization, each power module's fans will start running, each power module will start establishing DC BUS voltage and each power module's LED indicator will illuminate green.
 - (2) Each parallel communication card's LED indicator will illuminate red first and then each card will start initialization. After initialization, the master parallel communication card's LED indicator will illuminate green and the backup communication card's LED indicator will illuminate yellow.

For the locations of the parallel communication cards, auxiliary power cards, power modules and their LED indicators, please refer to **Figure 6-2**.

- 5) After 20 seconds of LCD initialization, the LCD will enter the **Main Screen**. For the **Main Screen** information, please refer to **7.6 Main Screen**.

Now, each power module keeps running and its LED indicator remains green. After each power module finishes establishing DC BUS voltage, the charger will start to charge the batteries.

If the bypass AC source is within the normal range, the UPS will transfer to run in Bypass mode, the LCD screen will show as **Figure 6-11** and the tri-color LED indicator will illuminate yellow. For the location of the tri-color LED indicator, please refer to **Figure 2-11**.

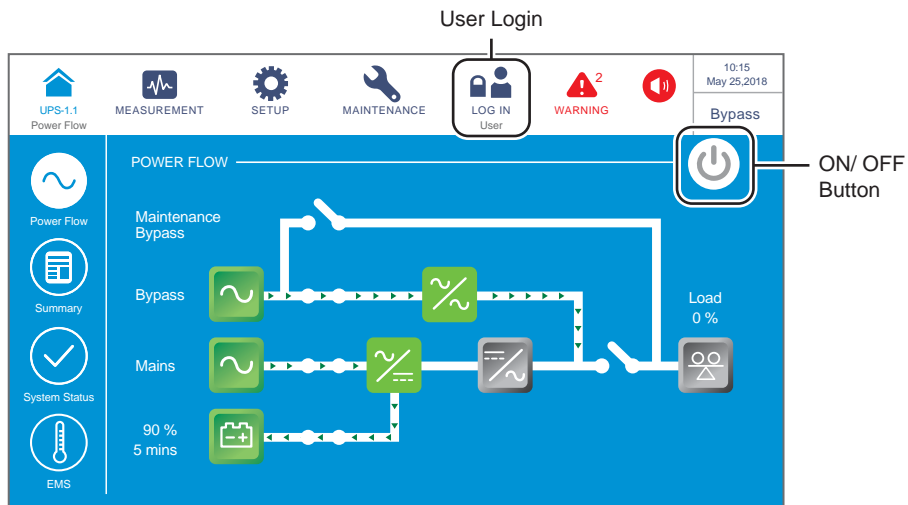

(Figure 6-11: Main Screen_ User Login & ON/ OFF Button Location)

- 6) For parallel application, please check each parallel UPS's parallel settings. Please note that each parallel UPS's parallel ID No. must be different, and parallel group ID No., input, output and battery settings must be the same.
- 7) For parallel application, tap the icon () located in the upper left corner of the screen and check if the parallel group ID No. and parallel ID No. of the parallel UPSs are correct. The UPS with the smallest parallel ID No. is defined as the master unit. Please refer to **Figure 6-12**.

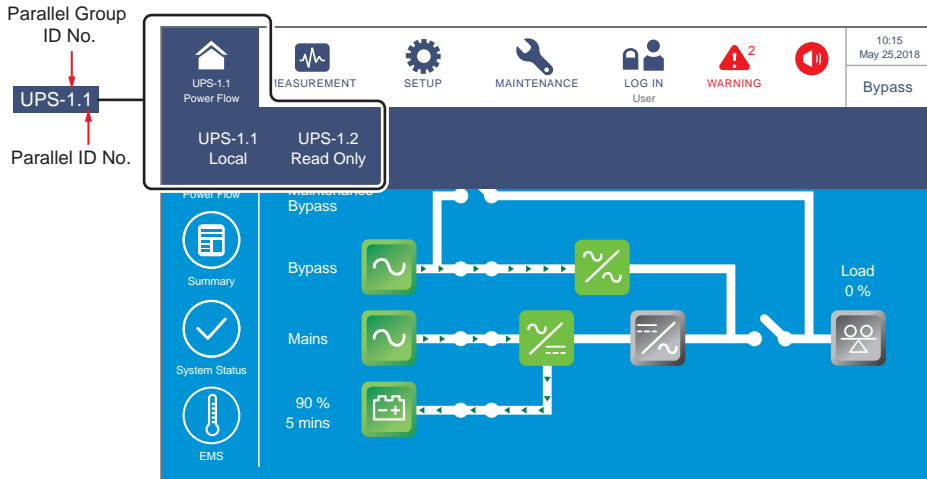

(Figure 6-12: Parallel Group ID No. & Parallel ID No. Inquiry Screen)

8 For single unit, turn **ON** the Output Breaker (Q4).

For parallel units, ensure that the output voltage difference between each parallel UPS is below 3V. If larger than 3V, it is abnormal; please contact service personnel immediately. If below 3V, turn **ON** each parallel UPS's Output Breaker (Q4).

Now, the tri-color LED indicator illuminates yellow and the LCD shows the following screen (see **Figure 6-13**). For the location of the tri-color LED indicator, please refer to **Figure 2-11**.

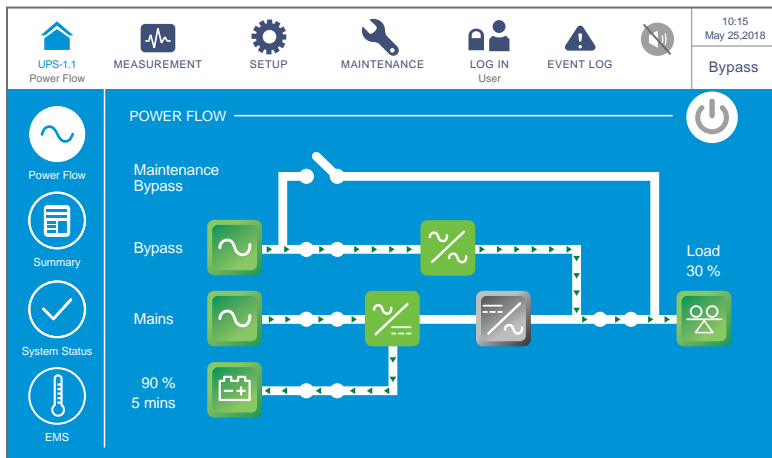

(Figure 6-13: Bypass Mode Screen)

6.2.4 Manual Bypass Mode Start-up Procedures



WARNING:

1. For parallel units, ensure that every operation procedure mentioned below is synchronized to all parallel UPSs.
2. For parallel application, if you just want to operate a specific UPS but not all parallel ones, please contact service personnel.
3. Please note that you can turn on the External Manual Bypass Breaker (Q3) only when the UPS needs maintenance. In Manual Bypass mode, power supply of the connected critical loads comes from the manual bypass and the output is not protected. Please ensure that the bypass AC source is normal.
4. In Manual Bypass mode, power supply of the critical loads comes from the manual bypass; thus, maintenance personnel can perform maintenance without interrupting the power supplying to the critical loads.
5. Ensure that all of the breakers (except the External Manual Bypass Breaker (Q3)) are in the **OFF** position, and use a voltmeter to check if there is any high voltage inside the UPS. Only after you have confirmed that there is no high voltage in the UPS can service personnel perform UPS maintenance.
6. During the UPS maintenance process, do not touch the following parts: AC Input terminal block, Bypass Input terminal block, UPS Output terminal block, Battery Input terminal block, grounding terminals (see **Figure 5-11~Figure 5-13** for the location of these terminal blocks and terminals) and any copper bars connected to the External Manual Bypass Breaker (Q3), as they may carry high voltage.

• From On-Line Mode to Manual Bypass Mode

- 1 In On-Line mode, the LCD's main screen shows as follows and the tri-color LED indicator illuminates green. For the tri-color LED indicator location, please refer to **Figure 2-11**.

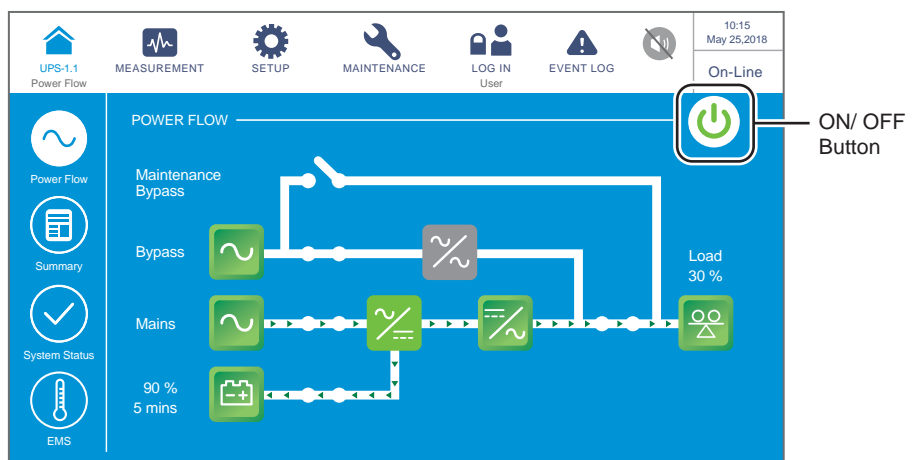

(Figure 6-14: On-Line Mode Screen_ User Login & ON/ OFF Button Location)

- 2) Check if the bypass voltage and STS module are normal or not.
- 3) If normal, tap the ON/ OFF Button () and the following screen will pop up to ask if you want to power off the UPS's inverter.

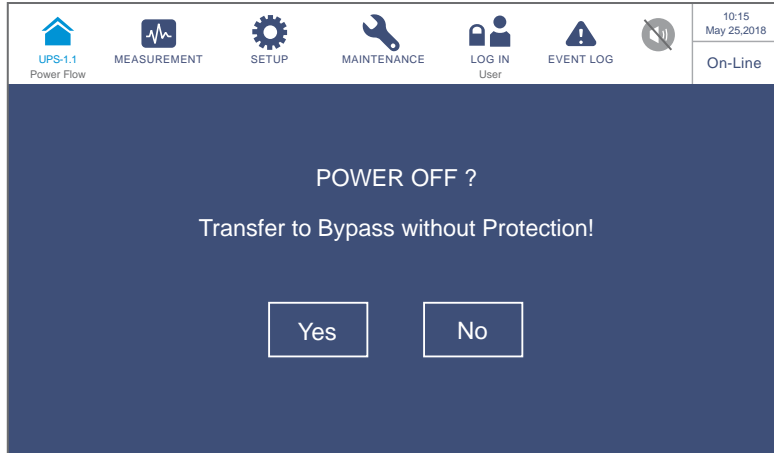

(Figure 6-15: Power off Reminder Screen)

- 4) If normal, please select 'YES'. After that, the UPS will shut down the inverter and transfer to run in Bypass mode.
- 5) Ensure that the UPS runs in Bypass mode. After confirmation, turn **ON** the External Manual Bypass Breaker (Q3).
- 6) Switch **OFF** the Input Breaker (Q1), Bypass Breaker (Q2) and Output Breaker (Q4). After that, the screen shows as follows.

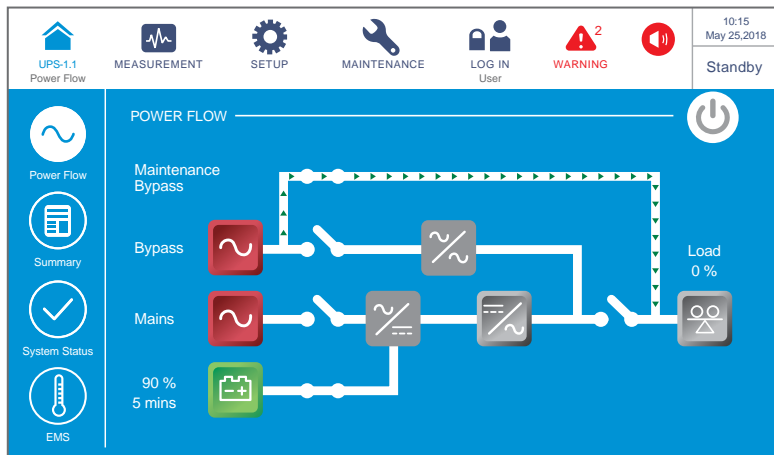

(Figure 6-16: On-Line Mode to Manual Bypass Mode Screen)

- 7 When the UPS performs DC BUS discharging, each power module's LED indicator flashes green. After discharging, each power module's LED indicator will be off.
- 8 About three minutes later, the UPS will shut down, and the LCD and the tri-color LED will be off.
- 9 Switch **OFF** every external battery cabinet's breaker (Q5).

• **From Manual Bypass Mode to Online Mode**



WARNING:

1. For parallel units, please follow **6.2.3 Bypass Mode Start-up Procedures** to turn on each parallel UPS. After confirming that parallel operation works normally, follow the procedures below step by step.
2. For parallel units, ensure that every operation procedure mentioned below is synchronized to all parallel UPSs.
3. For parallel application, if you just want to operate a specific UPS but not all parallel ones, please contact service personnel.

- 1 Switch **ON** every external battery cabinet's breaker (Q5).
- 2 Switch **ON** the Bypass Breaker (Q2) and wait for the LCD initial screenn (see **Figure 6-17**). After that, turn **ON** the Input Breaker (Q1) and Output Breaker (Q4).



(Figure 6-17: LCD Initial Screen)

- 3 After you switch **ON** the Input Breaker (Q1) and Bypass Breaker (Q2), each auxiliary power card's LED indicator will illuminate green and the following status will occur simultaneously.
 - (1) The system and each power module will start initialization. After each power module finishes initialization, each power module's fans will start running, each power module will start establishing DC BUS voltage and each power module's LED indicator will illuminate green.

- (2) Each parallel communication card's LED indicator will illuminate red first and then each card will start initialization. After initialization, the master parallel communication card's LED indicator will illuminate green and the backup communication card's LED indicator will illuminate yellow.

For the locations of the parallel communication cards, auxiliary power cards, power modules and their LED indicators, please refer to **Figure 6-2**.

- 4 After 20 seconds of LCD initialization, the LCD will enter the **Main Screen**. For the **Main Screen** information, please refer to **7.6 Main Screen**.

Now, each power module keeps running and its LED indicator remains green. After each power module finishes establishing DC BUS voltage, the charger will start to charge the batteries.

If the bypass AC source is within the normal range, the UPS will transfer to run in Bypass mode, the LCD screen will show as **Figure 6-18** and the tri-color LED indicator will illuminate yellow. For the location of the tri-color LED indicator, please refer to **Figure 2-11**.

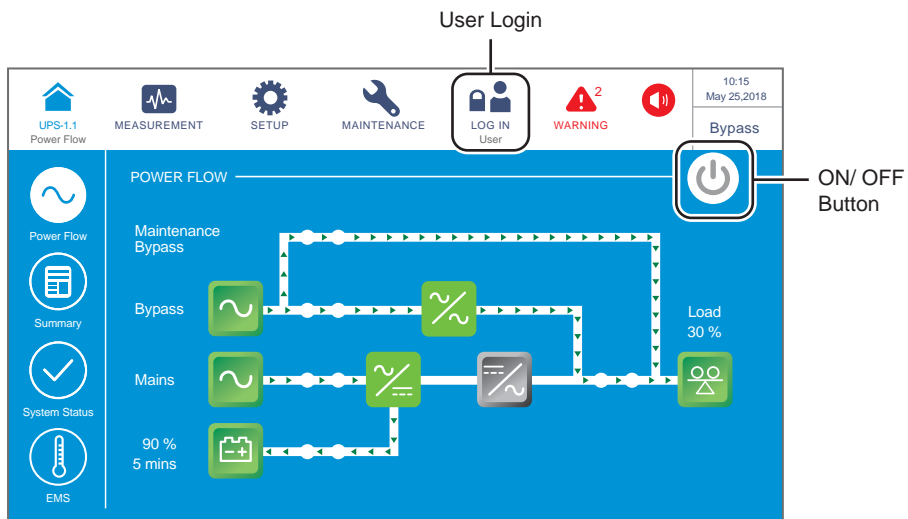

(Figure 6-18: Bypass Mode Screen_ User Login & ON/ OFF Button Location)

- 5 Switch **OFF** the External Manual Bypass Breaker (Q3).

- 6 Tap the ON/ OFF Button () and the following screen will pop up to ask if you want to power on the UPS's inverter. Please select 'YES'.

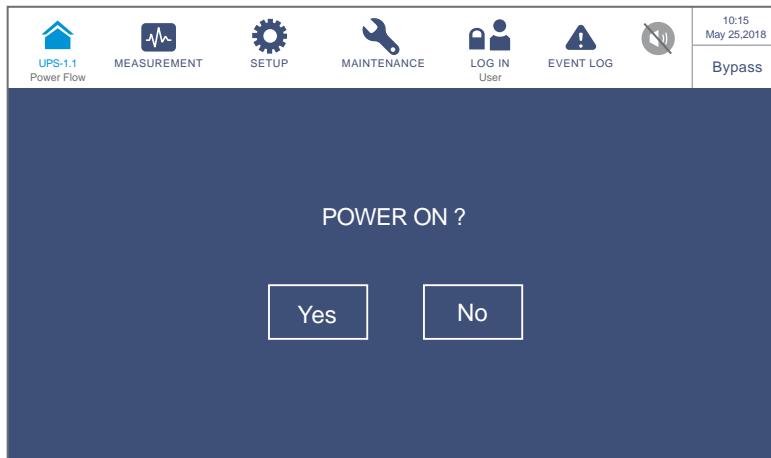

(Figure 6-19: Power on Reminder Screen)

- 7 After selection of 'YES' to start up the UPS's inverter, each power module will start up and perform self-inspection. At the same time, the system begins synchronization with the bypass AC source. After the self-inspection is completed, the UPS will automatically transfer to run in On-Line mode, the tri-color LED indicator will illuminate green and the following screen will appear. For the tri-color LED indicator location, please refer to **Figure 2-11**.

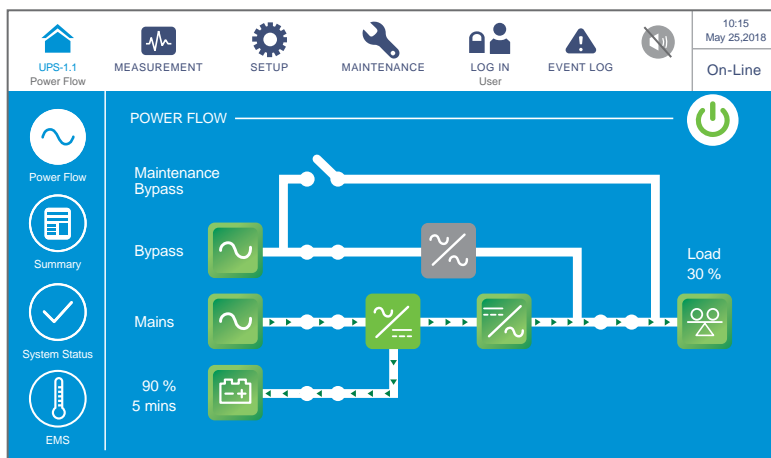

(Figure 6-20: On-Line Mode Screen)

6.2.5 ECO Mode Start-up Procedures



WARNING:

1. For parallel units, please follow **6.2.3 Bypass Mode Start-up Procedures** to turn on each parallel UPS. After confirming that parallel operation works normally, follow the procedures below step by step.
2. For parallel units, ensure that every operation procedure mentioned below is synchronized to all parallel UPSs.
3. For parallel application, if you just want to operate a specific UPS but not all parallel ones, please contact service personnel.

- ① Ensure that the External Manual Bypass Breaker (Q3) is in the **OFF** position.
- ② Switch **ON** every external battery cabinet's breaker (Q5).
- ③ Switch **ON** the Bypass Breaker (Q2) and wait for the LCD initial screen (see **Figure 6-21**). After that, turn **ON** the Input Breaker (Q1) and Output Breaker (Q4).



(Figure 6-21: LCD Initial Screen)

- ④ After you switch **ON** the Input Breaker (Q1) and Bypass Breaker (Q2), each auxiliary power card's LED indicator will illuminate green and the following status will occur simultaneously.
 - (1) The system and each power module will start initialization. After each power module finishes initialization, each power module's fans will start running, each power module will start establishing DC BUS voltage and each power module's LED indicator will illuminate green.

- (2) Each parallel communication card's LED indicator will illuminate red first and then each card will start initialization. After initialization, the master parallel communication card's LED indicator will illuminate green and the backup communication card's LED indicator will illuminate yellow.

For the locations of the parallel communication cards, auxiliary power cards, power modules and their LED indicators, please refer to **Figure 6-2**.

- 5 After 20 seconds of LCD initialization, the LCD will enter the **Main Screen**. For the **Main Screen** information, please refer to **7.6 Main Screen**.

Now, each power module keeps running and its LED indicator remains green. After each power module finishes establishing DC BUS voltage, the charger will start to charge the batteries.

If the bypass AC source is within the normal range, the UPS will transfer to run in Bypass mode, the LCD screen will show as **Figure 6-22** and the tri-color LED indicator will illuminate yellow. For the location of the tri-color LED indicator, please refer to **Figure 2-11**.

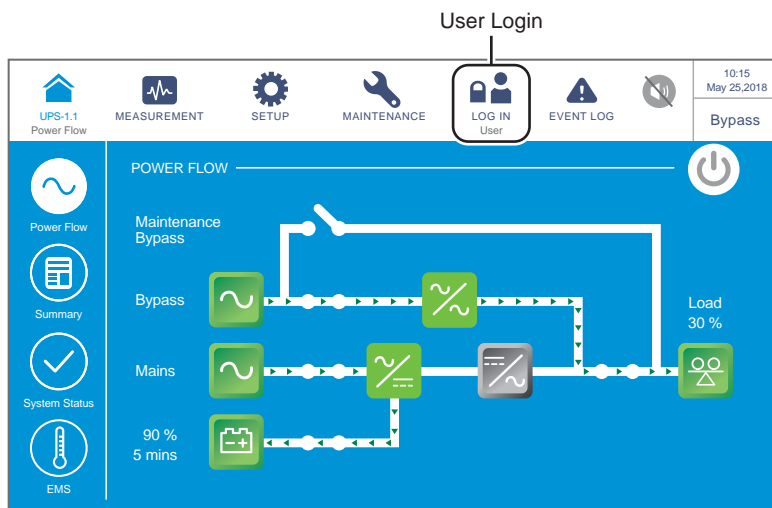

(Figure 6-22: Main Screen_ User Login)

- 6 Please log in as an **Administrator**. For the **Administrator** password, please contact service personnel. After login, ensure that you are in the **Administrator** login status (see **Figure 6-23**).

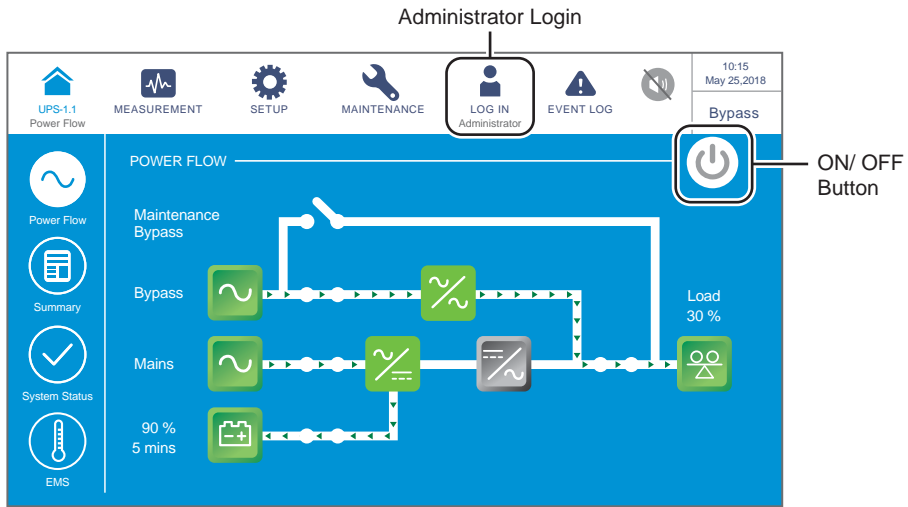

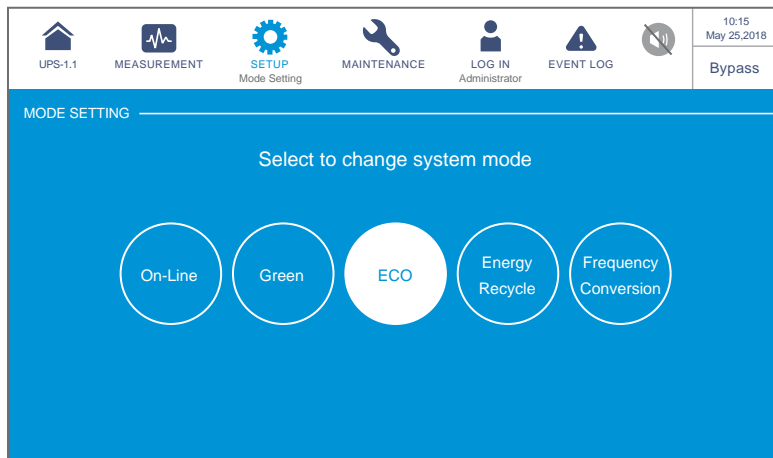

(Figure 6-23: Main Screen_ Administrator Login & ON/ OFF Button Location)

- 7 Go to **SETUP** → **Mode Setting** → **ECO**.



(Figure 6-24: Select ECO Mode)

- 8 After manually selecting **ECO** mode via the LCD, tap the icon () located in the upper left corner of the screen to go back to the **Main Screen**.

- 9 Tap the ON/ OFF Button () and the following screen will pop up to ask if you want to power on the UPS's inverter. Please select 'YES'.

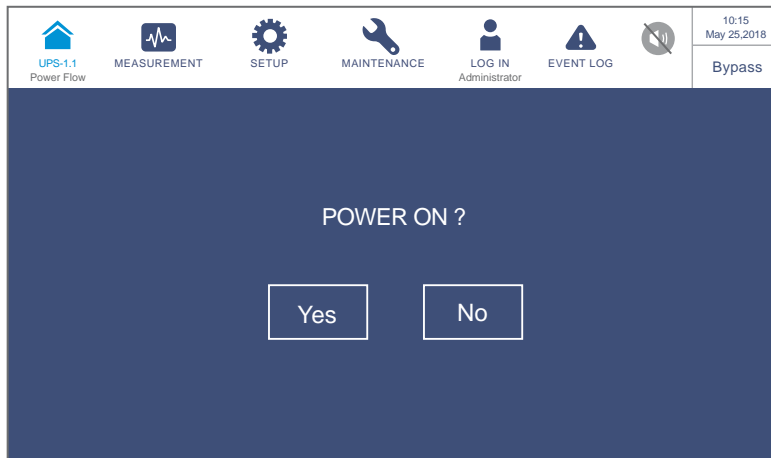

(Figure 6-25: Power on Reminder Screen)

- 10 After selection of 'YES' to start up the UPS's inverter, each power module will start up and perform self-inspection. At the same time, the system begins synchronization with the bypass AC source. After the self-inspection is completed, the UPS will automatically transfer to run in On-Line mode. After the system confirms that the bypass voltage is normal, the UPS will automatically switch to run in ECO mode to let the bypass AC source supply power (see **Figure 6-26**). Now, the tri-color LED indicator illuminates green and the following screen appears. For the tri-color LED indicator location, please refer to **Figure 2-11**.

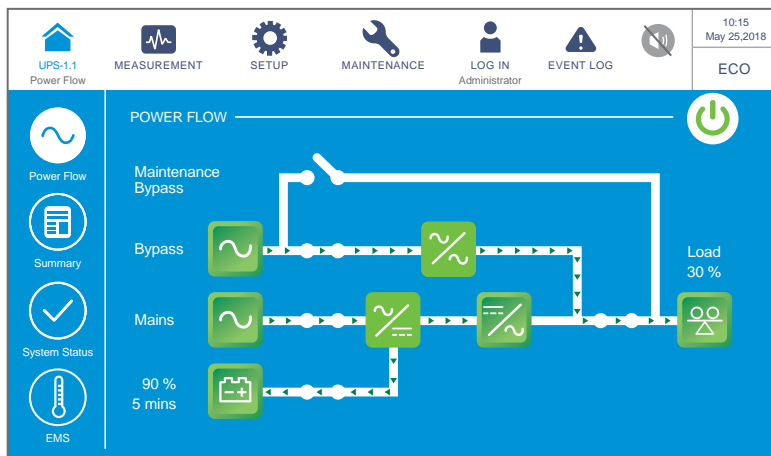

(Figure 6-26: ECO Mode Screen)

6.2.6 Frequency Conversion Mode Start-up Procedures



WARNING:

1. Frequency Conversion mode is only applicable to single UPS but not to parallel UPSs.
2. When the UPS runs in Frequency Conversion mode, once the inverter becomes off, there is no bypass power supplying to the loads.

- 1 Ensure that the External Manual Bypass Breaker (Q3) is in the **OFF** position.
- 2 Switch **ON** every external battery cabinet's breaker (Q5).
- 3 Switch **ON** the Bypass Breaker (Q2) and wait for the LCD initial screen (see **Figure 6-27**). After that, turn **ON** the Input Breaker (Q1).



(Figure 6-27: LCD Initial Screen)

- 4 After you switch **ON** the Input Breaker (Q1) and Bypass Breaker (Q2), each auxiliary power card's LED indicator will illuminate green and the following status will occur simultaneously.
 - (1) The system and each power module will start initialization. After each power module finishes initialization, each power module's fans will start running, each power module will start establishing DC BUS voltage and each power module's LED indicator will illuminate green.
 - (2) Each parallel communication card's LED indicator will illuminate red first and then each card will start initialization. After initialization, the master parallel communication card's LED indicator will illuminate green and the backup communication card's LED indicator will illuminate yellow.

For the locations of the parallel communication cards, auxiliary power cards, power modules and their LED indicators, please refer to **Figure 6-2**.

- 5 After 20 seconds of LCD initialization, the LCD will enter the **Main Screen**. For the **Main Screen** information, please refer to **7.6 Main Screen**.

Now, each power module keeps running and its LED indicator remains green. After each power module finishes establishing DC BUS voltage, the charger will start to charge the batteries.

If the bypass AC source is within the normal range, the UPS will transfer to run in Bypass mode, the LCD screen will show as **Figure 6-28** and the tri-color LED indicator will illuminate yellow. For the location of the tri-color LED indicator, please refer to **Figure 2-11**.

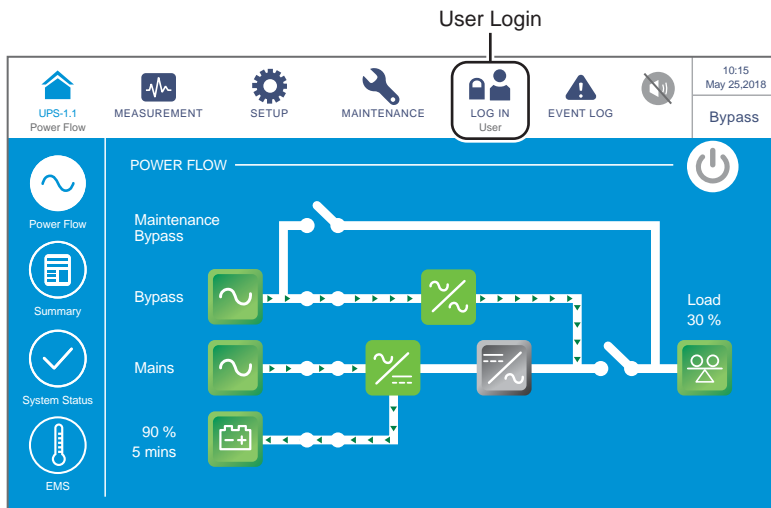

(Figure 6-28: Main Screen_ User Login)

- 6 Please log in as an **Administrator**. For the **Administrator** password, please contact service personnel. After login, ensure that you are in the **Administrator** login status (see **Figure 6-29**).

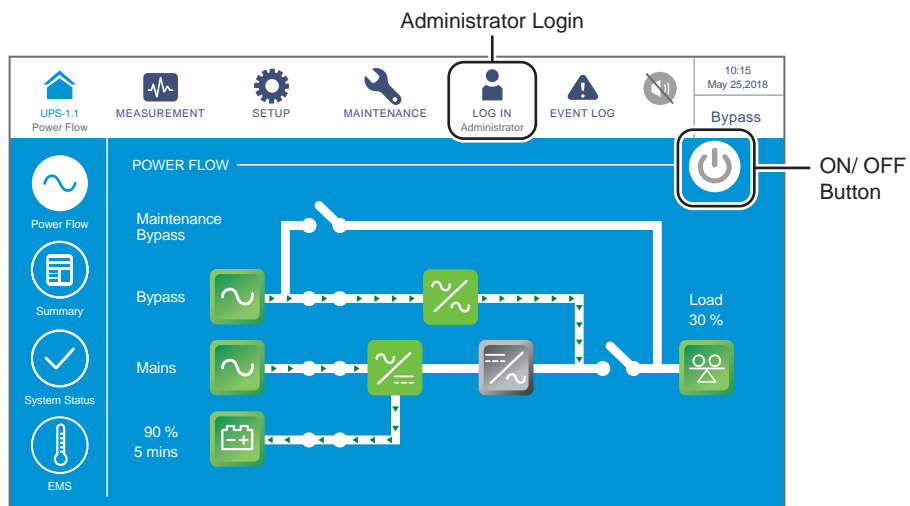

(Figure 6-29: Main Screen_ Administrator Login & ON/ OFF Button Location)

- 7 Go to **SETUP** → **Mode Setting** → **Frequency Conversion**.



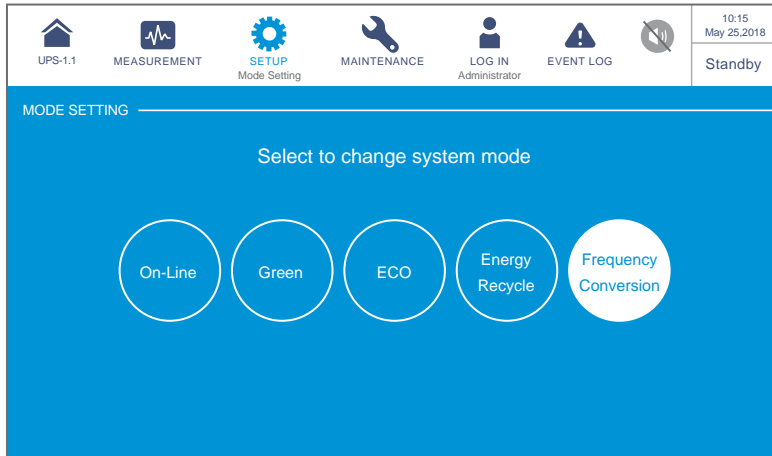

WARNING:

Please note that, once you select '**Frequency Conversion**' mode via the LCD, the UPS will run in Standby mode and the output will be terminated.



(Figure 6-30: Select Frequency Conversion Mode)

- 8 Tap the icon () located in the upper left corner of the screen to go back to the **Main Screen**.
- 9 Tap the ON/ OFF Button () and the following screen will pop up to ask if you want to power on the UPS's inverter. Please select '**YES**'.

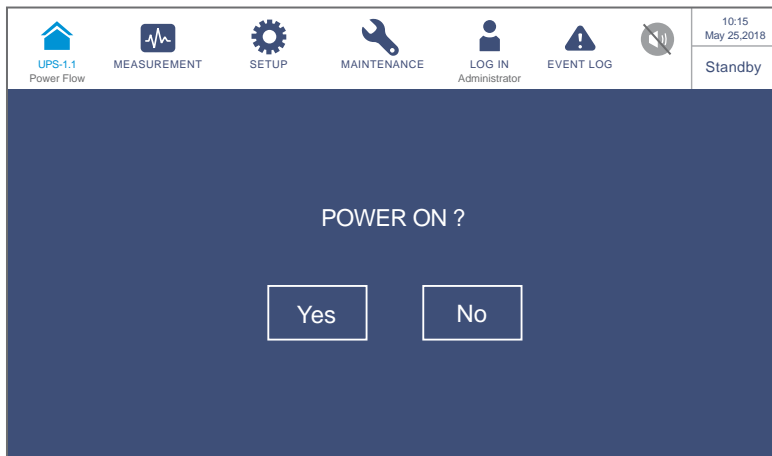

(Figure 6-31: Power on Reminder Screen)

- 10 After selection of '**YES**' to start up the UPS's inverter, each power module will start up and perform self-inspection. After the self-inspection is completed, the UPS will automatically transfer to run in Frequency Conversion mode and the output frequency will be the same as setup value. Now, the tri-color LED indicator illuminates green and the following screen appears. For the tri-color LED indicator location, please refer to **Figure 2-11**.

- 11) Switch on the Output Breaker (Q4).

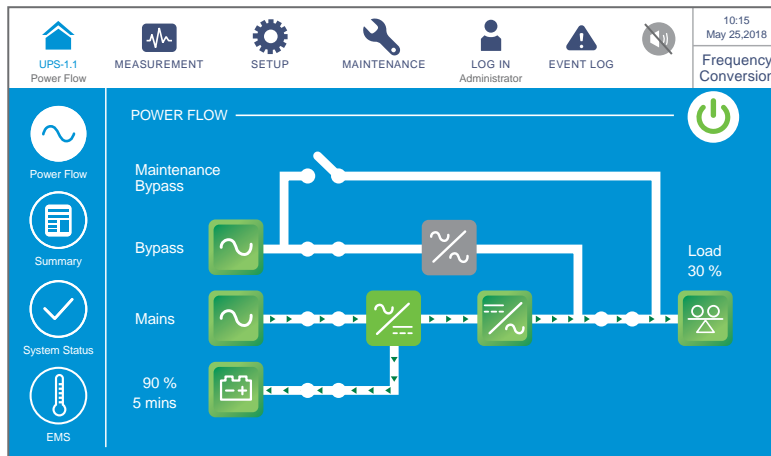

(Figure 6-32: Frequency Conversion Mode Screen)

6.2.7 Green Mode Start-up Procedures



WARNING:

Green mode is only applicable to single UPS but not to parallel UPSs.

- 1) Ensure that the External Manual Bypass Breaker (Q3) is in the **OFF** position.
- 2) Switch **ON** every external battery cabinet's breaker (Q5).
- 3) Switch **ON** the Bypass Breaker (Q2) and wait for the LCD initial screen (see **Figure 6-33**). After that, turn **ON** the Input Breaker (Q1) and Output Breaker (Q4).



(Figure 6-33: LCD Initial Screen)

- 4) After you switch **ON** the Input Breaker (Q1) and Bypass Breaker (Q2), each auxiliary power card's LED indicator will illuminate green and the following status will occur simultaneously.

- (1) The system and each power module will start initialization. After each power module finishes initialization, each power module's fans will start running, each power module will start establishing DC BUS voltage and each power module's LED indicator will illuminate green.
- (2) Each parallel communication card's LED indicator will illuminate red first and then each card will start initialization. After initialization, the master parallel communication card's LED indicator will illuminate green and the backup communication card's LED indicator will illuminate yellow.

For the locations of the parallel communication cards, auxiliary power cards, power modules and their LED indicators, please refer to **Figure 6-2**.

- 5 After 20 seconds of LCD initialization, the LCD will enter the **Main Screen**. For the **Main Screen** information, please refer to **7.6 Main Screen**.

Now, each power module keeps running and its LED indicator remains green. After each power module finishes establishing DC BUS voltage, the charger will start to charge the batteries.

If the bypass AC source is within the normal range, the UPS will transfer to run in Bypass mode, the LCD screen will show as **Figure 6-34** and the tri-color LED indicator will illuminate yellow. For the location of the tri-color LED indicator, please refer to **Figure 2-11**.

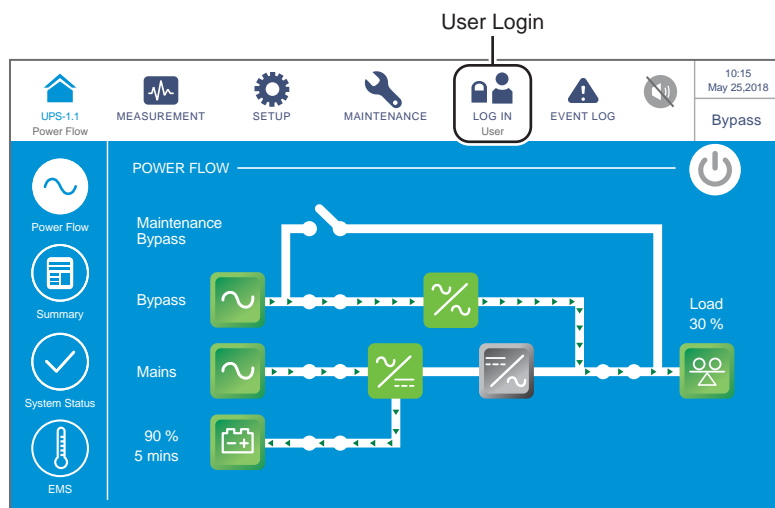

(Figure 6-34: Main Screen_ User Login)

- 6 Please log in as an **Administrator**. For the **Administrator** password, please contact service personnel. After login, ensure that you are in the **Administrator** login status (see **Figure 6-35**).

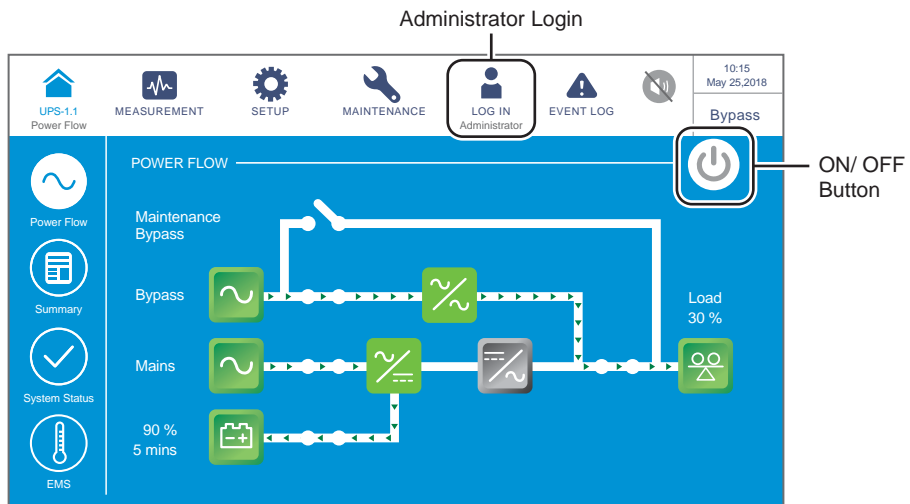

(Figure 6-35: Main Screen_ Administrator Login & ON/ OFF Button Location)

- 7 Go to **SETUP** → **Mode Setting** → **Green**.

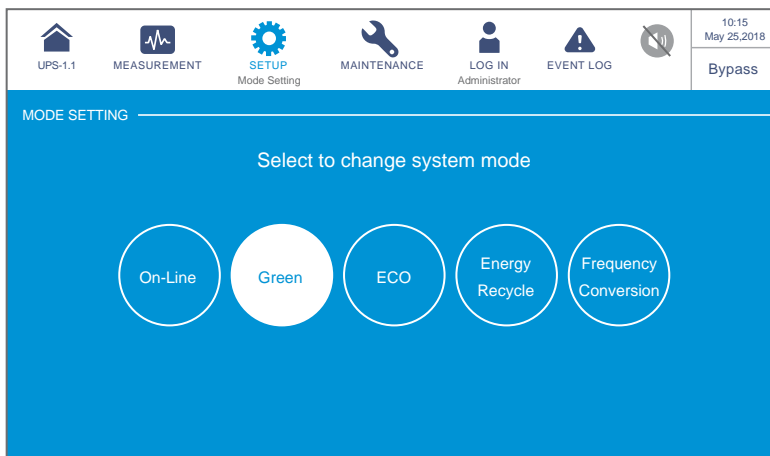

(Figure 6-36: Select Green Mode)

- 8 After manually selecting **Green** mode via the LCD, tap the icon () located in the upper left corner of the screen to go back to the **Main Screen**.

- 9 Tap the ON/ OFF Button (🔌) and the following screen will pop up to ask if you want to power on the UPS's inverter. Please select **'YES'**.

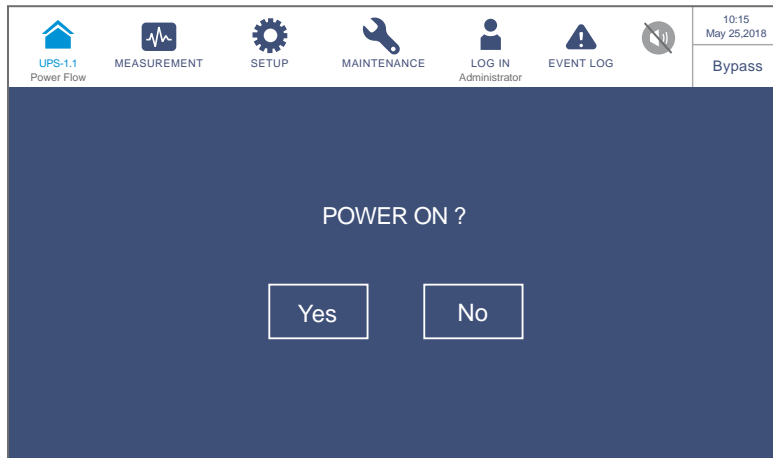

(Figure 6-37: Power on Reminder Screen)

- 10 After selection of **'YES'** to start up the UPS's inverter, each power module will start up and perform self-inspection. At the same time, the system begins synchronization with the bypass AC source. After the self-inspection is completed, the UPS will automatically transfer to run in Green mode and the system will automatically detect the output status (i.e. total load capacity %) to decide which specific power modules should be fully powered on or idle in order to achieve higher efficiency of the UPS. Now, the tri-color LED indicator illuminates green and the following screen appears. For the tri-color LED indicator location, please refer to **Figure 2-11**.

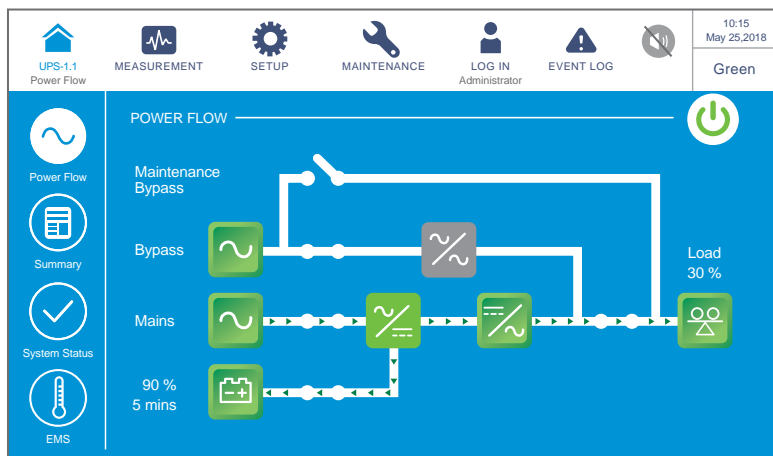

(Figure 6-38: Green Mode Screen)

6.2.8 Energy Recycle Mode Start-up Procedures



WARNING: Energy Recycle mode is only applicable to single input and single unit application.

- 1) Ensure that the External Manual Bypass Breaker (Q3), Output Breaker (Q4) and every external battery cabinet's breaker (Q5) are in the **OFF** position.
- 2) Switch **ON** the Bypass Breaker (Q2) and wait for the LCD initial screen (see **Figure 6-39**). After that, turn **ON** the Input Breaker (Q1).



(Figure 6-39: LCD Initial Screen)

- 3) After you switch **ON** the Input Breaker (Q1) and Bypass Breaker (Q2), each auxiliary power card's LED indicator will illuminate green and the following status will occur simultaneously.
 - (1) The system and each power module will start initialization. After each power module finishes initialization, each power module's fans will start running.
 - (2) Each parallel communication card's LED indicator will illuminate red first and then each card will start initialization. After initialization, the master parallel communication card's LED indicator will illuminate green and the backup communication card's LED indicator will illuminate yellow.

For the locations of the parallel communication cards, auxiliary power cards, power modules and their LED indicators, please refer to **Figure 6-2**.

- 4) After 20 seconds of LCD initialization, the LCD will enter the **Main Screen**. For the **Main Screen** information, please refer to **7.6 Main Screen**.

If the bypass AC source is within the normal range, the UPS will transfer to run in Bypass mode, the LCD screen will show as **Figure 6-40** and the tri-color LED indicator will illuminate yellow. For the location of the tri-color LED indicator, please refer to **Figure 2-11**.

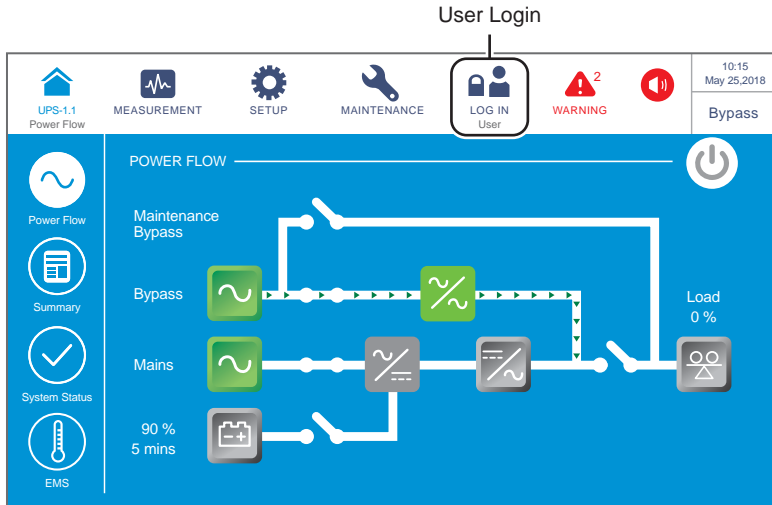

(Figure 6-40: Main Screen_ User Login)

- 5 Please log in as an **Administrator**. For the **Administrator** password, please contact service personnel. After login, ensure that you are in the **Administrator** login status (see **Figure 6-41**).

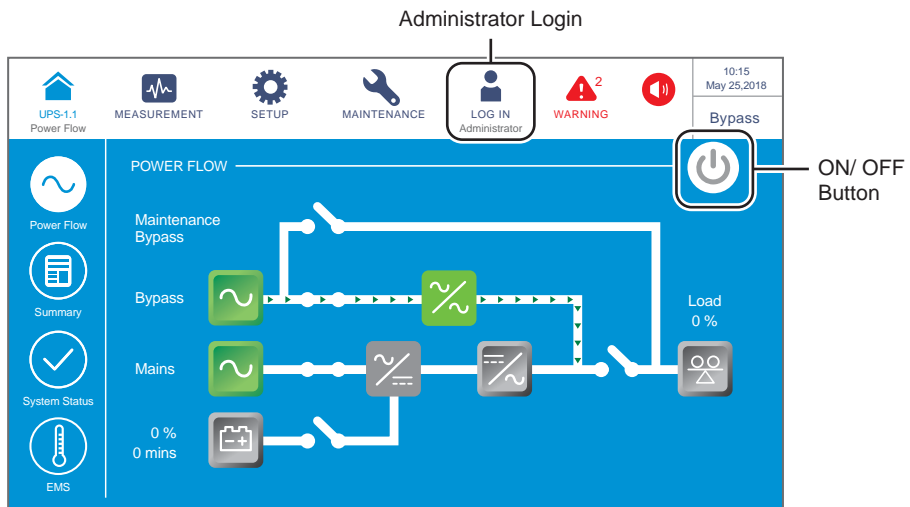

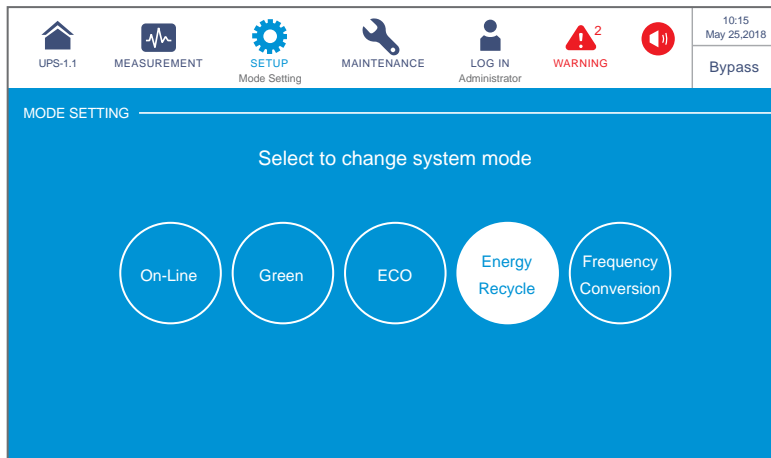

(Figure 6-41: Main Screen_ Administrator Login & ON/ OFF Button Location)

- 6 Go to **SETUP** → **Mode Setting** → **Energy Recycle**.



(Figure 6-42: Select Energy Recycle Mode)

- 7 After manually selecting **Energy Recycle** mode via the LCD, tap the icon () located in the upper left corner of the screen to go back to the **Main Screen**.
- 8 Tap the ON/ OFF Button () and the following screen will pop up to ask if you want to power on the UPS's inverter. Please select '**YES**'.

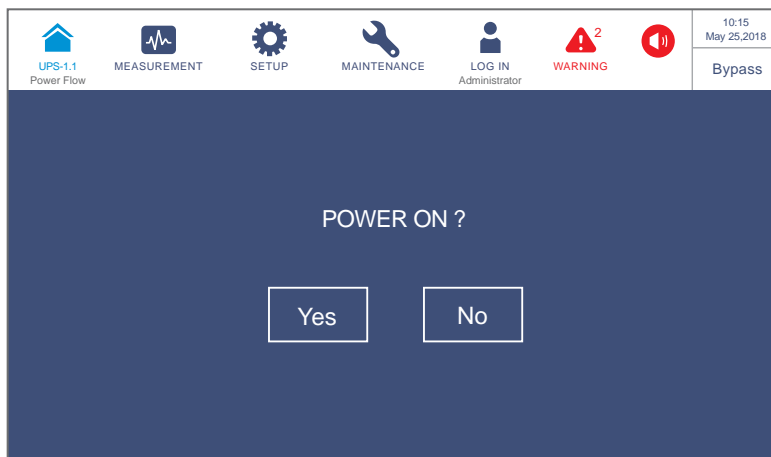

(Figure 6-43: Power on Reminder Screen)

- 9 After selection of '**YES**' to start up the UPS's inverter, each power module will start up and perform self-inspection. At the same time, the system begins synchronization with the bypass AC source. After the self-inspection is completed, the UPS will automatically transfer to run in Energy Recycle mode and perform self-aging test. Now, the tri-color LED indicator illuminates yellow and the following screen appears. For the tri-color LED indicator location, please refer to **Figure 2-11**.

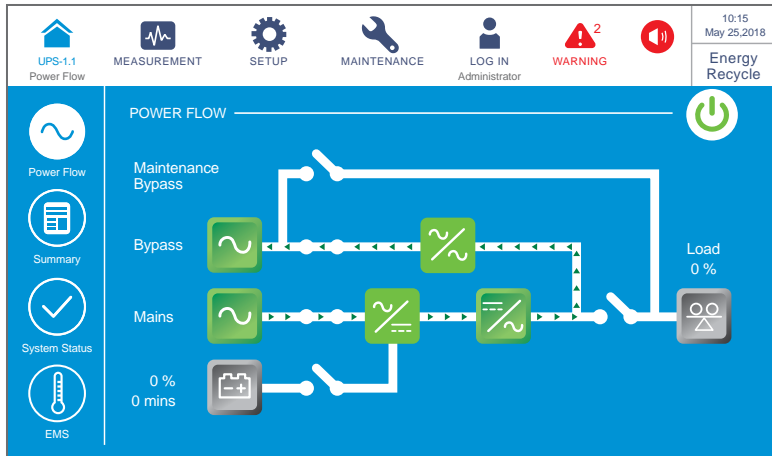

(Figure 6-44: Energy Recycle Mode Screen)

6.3 Turn-off Procedures

6.3.1 On-Line Mode Turn-off Procedures



WARNING:

1. For parallel units, ensure that every operation procedure mentioned below is synchronized to all parallel UPSs.
2. For parallel application, if you just want to operate a specific UPS but not all parallel ones, please contact service personnel.

①

In On-Line mode, the LCD shows the following screen (**Figure 6-45**) and the tri-color LED indicator illuminates green. For the tri-color LED indicator location, please refer to **Figure 2-11**.

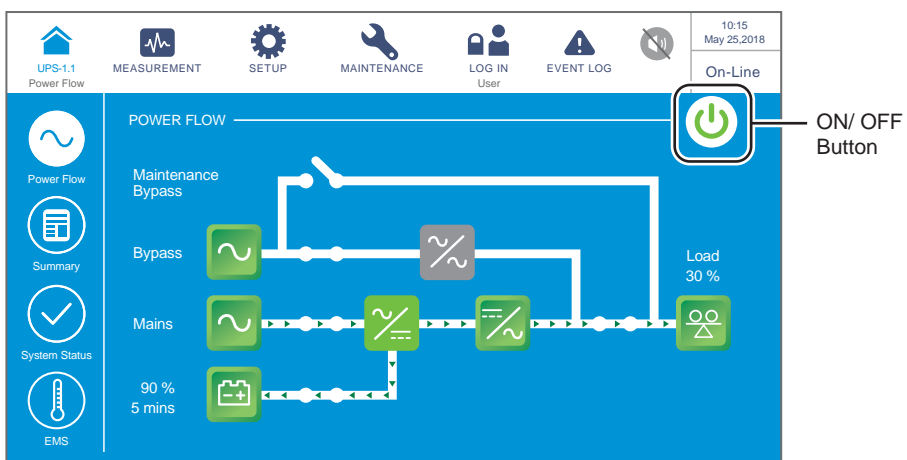

(Figure 6-45: On-Line Mode Screen & ON/ OFF Button Location)

- 2 Tap the ON/ OFF Button () and the following screen will pop up to ask if you want to power off the UPS's inverter. Please select 'YES'.

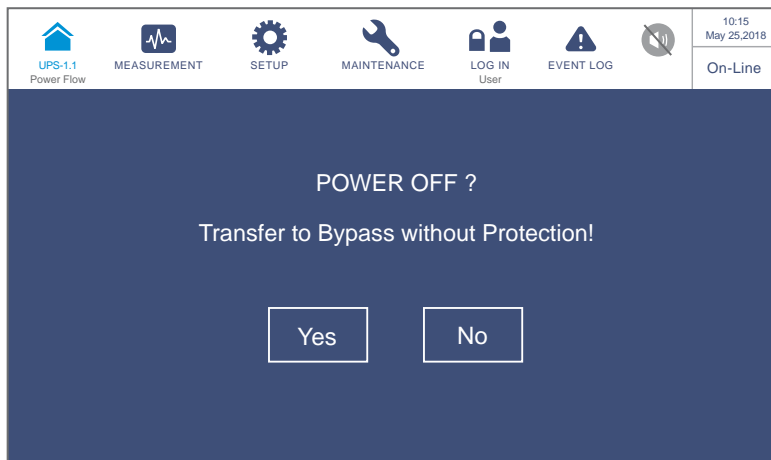

(Figure 6-46: Power off Reminder Screen)

- 3 After selection of 'YES', the UPS will shut down the inverter, terminate each power module's output and let the bypass AC source supply power. If the bypass AC source is abnormal, there is a risk of output interruption and the connected critical loads won't be protected. At this moment, each power module keeps charging the batteries, the tri-color LED indicator illuminates yellow and the following screen (Figure 6-47) appears. For the tri-color LED indicator location, please refer to Figure 2-11.

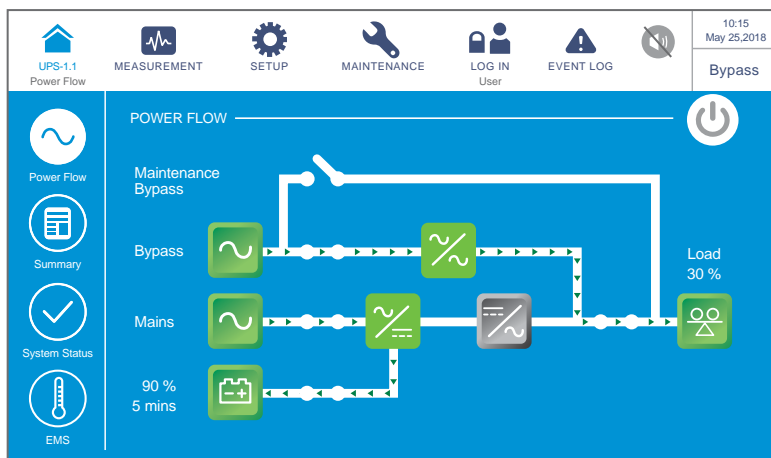

(Figure 6-47: Bypass Mode Screen)

- 4 Switch **OFF** the Input Breaker (Q1), Bypass Breaker (Q2) and Output Breaker (Q4). After that, the UPS will run in Standby mode.
- 5 Now, each power module performs DC BUS discharging and its LED indicator flashes green. After discharging, each power module's LED indicator will be off.
- 6 About 3 minutes later, the UPS will shut down, and the LCD and the tri-color LED indicator will be off.
- 7 Switch **OFF** every external battery cabinet's breaker (Q5).

6.3.2 Battery Mode Turn-off Procedures



WARNING:

1. For parallel units, ensure that every operation procedure mentioned below is synchronized to all parallel UPSs.
2. For parallel application, if you just want to operate a specific UPS but not all parallel ones, please contact service personnel.

- 1 In Battery mode, the LCD shows the following screen (**Figure 6-48**) and the tri-color LED indicator illuminates yellow. For the tri-color LED indicator location, please refer to **Figure 2-11**.

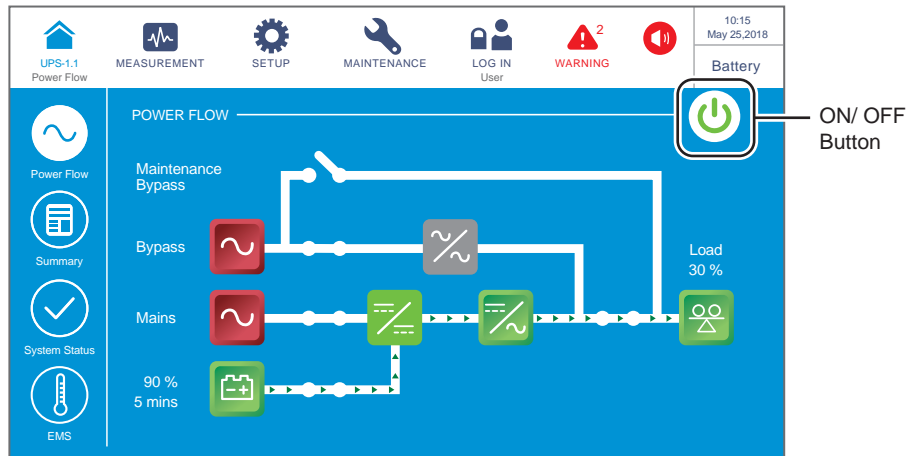

(Figure 6-48: Battery Mode Screen & ON/ OFF Button Location)

- 2 Tap the ON/ OFF Button () and the following screen will pop up to ask if you want to power off the UPS's inverter. Please select 'YES'.



WARNING:

Please note that, once you select 'YES', all power will be completely cut off. Please make sure that the critical loads connected to the UPS have already been safely shut down before you perform the turn-off procedures.

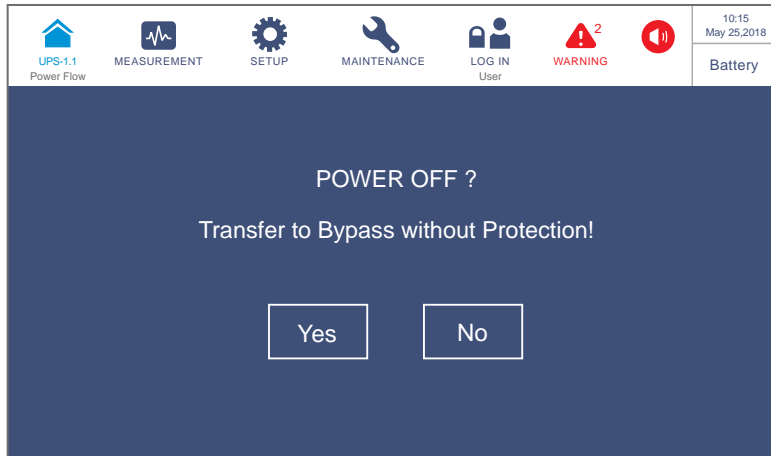

(Figure 6-49: Power off Reminder Screen)

- 3) After selection of 'YES', the UPS will shut down the inverter, terminate each power module's output and transfer to run in Standby mode. At this moment, the tri-color LED indicator illuminates yellow and the following screen (Figure 6-50) appears. For the tri-color LED indicator location, please refer to Figure 2-11.

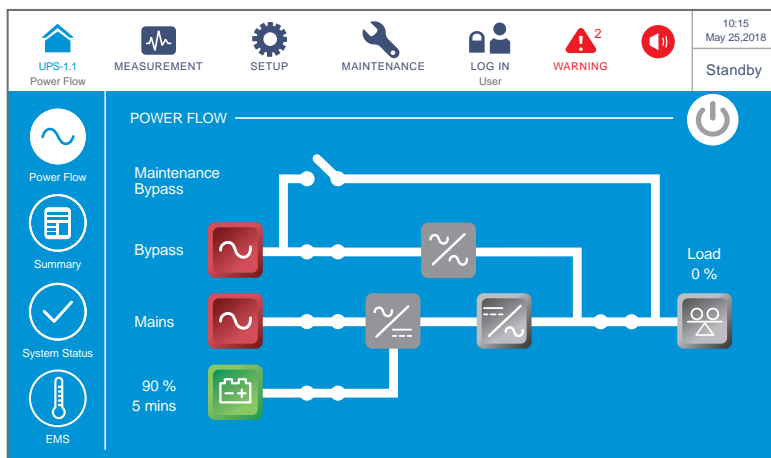

(Figure 6-50: Standby Mode Screen)

- 4) Switch **OFF** the Input Breaker (Q1), Bypass Breaker (Q2) and Output Breaker (Q4).
- 5) Now, each power module performs DC BUS discharging and its LED indicator flashes green. After discharging, each power module's LED indicator will be off.
- 6) About 3 minutes later, the UPS will shut down, and the LCD and the tri-color LED indicator will be off.
- 7) Switch **OFF** every external battery cabinet's breaker (Q5).

6.3.3 Bypass Mode Turn-off Procedures



WARNING:

1. For parallel units, ensure that every operation procedure mentioned below is synchronized to all parallel UPSs.
2. For parallel application, if you just want to operate a specific UPS but not all parallel ones, please contact service personnel.

- 1 In Bypass mode, the LCD shows the following screen (**Figure 6-51**) and the tri-color LED indicator illuminates yellow. For the tri-color LED indicator location, please refer to **Figure 2-11**.

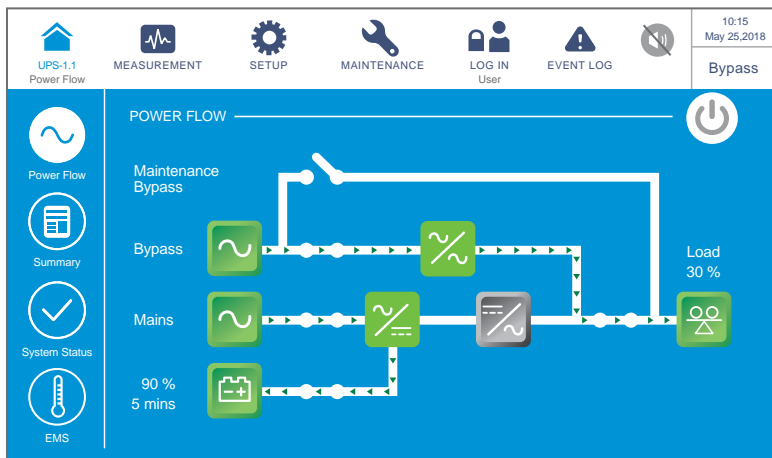

(Figure 6-51: Bypass Mode Screen)

- 2 Switch **OFF** the Input Breaker (Q1), Bypass Breaker (Q2) and Output Breaker (Q4). After that, the UPS will run in Standby mode.
- 3 Now, each power module performs DC BUS discharging and its LED indicator flashes green. After discharging, each power module's LED indicator will be off.
- 4 About 3 minutes later, the UPS will shut down, and the LCD and the tri-color LED indicator will be off.
- 5 Switch **OFF** every external battery cabinet's breaker (Q5).

6.3.4 Manual Bypass Mode Turn-off Procedures



WARNING:

1. For parallel units, ensure that every operation procedure mentioned below is synchronized to all parallel UPSs.
2. For parallel application, if you just want to operate a specific UPS but not all parallel ones, please contact service personnel.

In Manual Bypass mode, the LCD and the tri-color LED indicator are both **OFF**. To completely shut down the UPS, switch **OFF** the External Manual Bypass Breaker (Q3).



NOTE:

1. Ensure that the LCD, all LED indicators and fans are **OFF**.
2. Check that all breakers and power are **OFF**.

6.3.5 ECO Mode Turn-off Procedures



WARNING:

1. For parallel units, ensure that every operation procedure mentioned below is synchronized to all parallel UPSs.
2. For parallel application, if you just want to operate a specific UPS but not all parallel ones, please contact service personnel.

1 In ECO mode, the LCD shows the following screen (**Figure 6-52**) and the tri-color LED indicator illuminates green. For the tri-color LED indicator location, please refer to **Figure 2-11**.

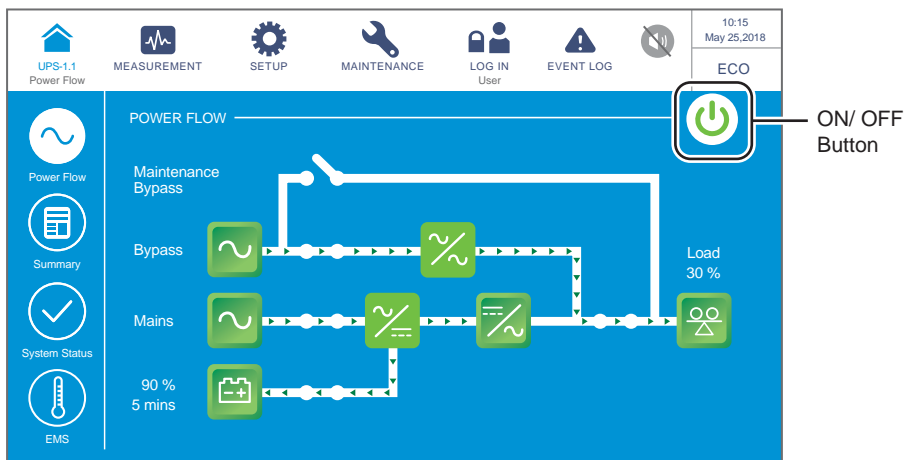

(Figure 6-52: ECO Mode Screen & ON/ OFF Button Location)

- 2 Tap the ON/ OFF Button () and the following screen will pop up to ask if you want to power off the UPS's inverter. Please select 'YES'.

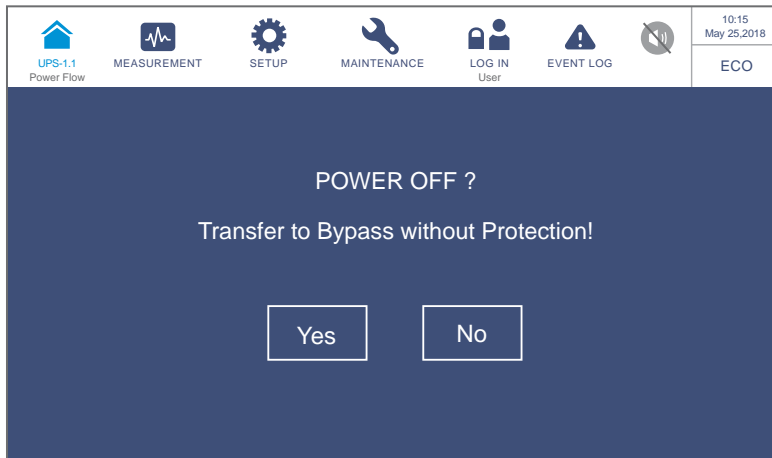

(Figure 6-53: Power off Reminder Screen)

- 3 After selection of 'YES', the UPS will shut down the inverter, terminate each power module's output and let the bypass AC source supply power. If the bypass AC source is abnormal, there is a risk of output interruption and the connected critical loads won't be protected. At this moment, each power module keeps charging the batteries, the tri-color LED indicator illuminates yellow and the following screen appears (Figure 6-54). For the tri-color LED indicator location, please refer to Figure 2-11.

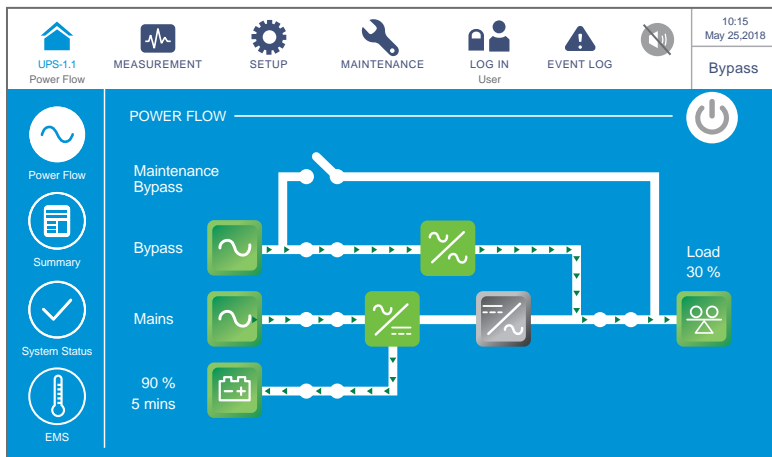

(Figure 6-54: Bypass Mode Screen)

- 4 Please log in as an **Administrator**. For the **Administrator** password, please contact service personnel. After login, ensure that you are in the **Administrator** login status (see **Figure 6-55**).

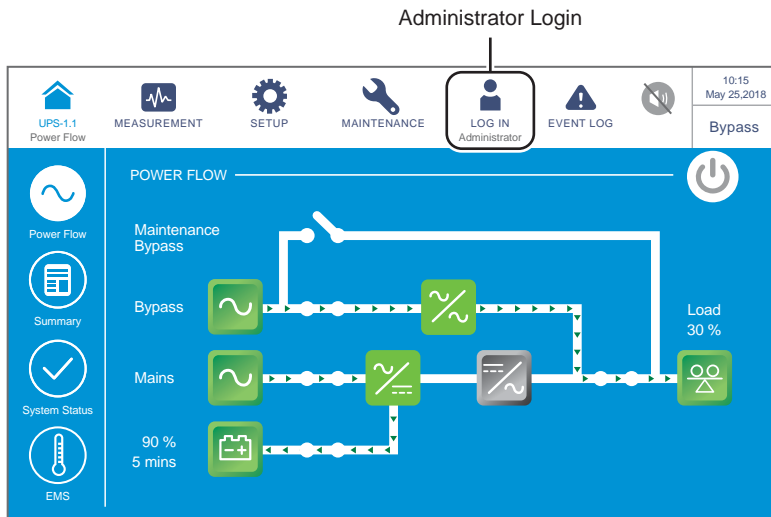

(Figure 6-55: Bypass Mode Screen_ Administrator Login)

- 5 Go to **SETUP** → **Mode Setting** → **On-Line**.

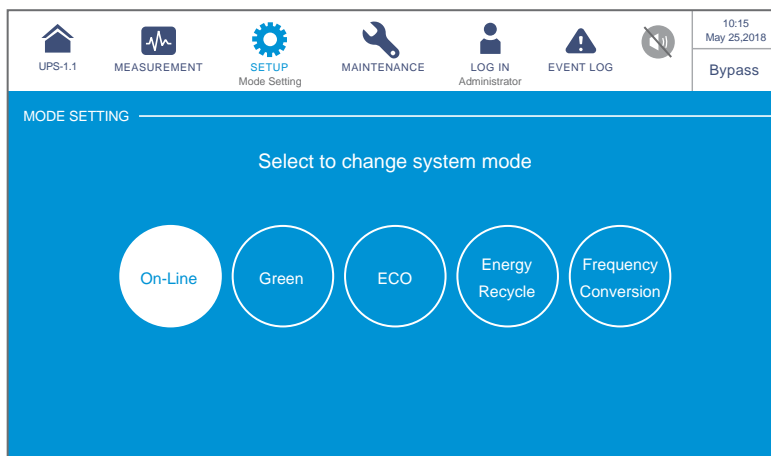

(Figure 6-56: Select Online Mode)

- 6 Switch **OFF** the Input Breaker (Q1), Bypass Breaker (Q2) and Output Breaker (Q4). After that, the UPS will run in Standby mode.
- 7 Now, each power module performs DC BUS discharging and its LED indicator flashes green. After discharging, each power module's LED indicator will be off.

- 8 About 3 minutes later, the UPS will shut down, and the LCD and the tri-color LED indicator will be off.
- 9 Switch **OFF** every external battery cabinet's breaker (Q5).

6.3.6 Frequency Conversion Mode Turn-off Procedures



WARNING:

1. Frequency Conversion mode is only applicable to single UPS but not to parallel UPSs.
2. When the UPS runs in Frequency Conversion mode, once the inverter becomes off, there is no bypass power supplying to the loads.

- 1 In Frequency Conversion mode, the LCD shows the following screen (**Figure 6-57**) and the tri-color LED indicator illuminates green. For the tri-color LED indicator location, please refer to **Figure 2-11**.

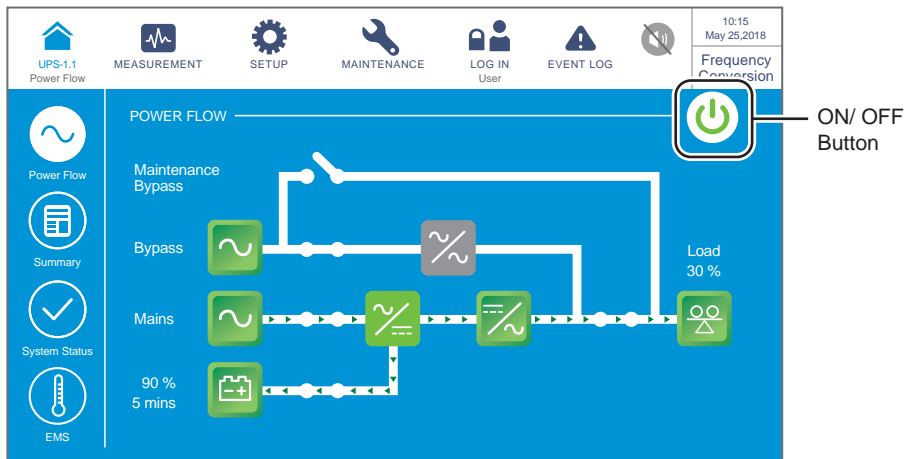

(Figure 6-57: Frequency Conversion Mode Screen & ON/ OFF Button Location)

- 2 Tap the ON/ OFF Button () and the following screen will pop up to ask if you want to power off the UPS's inverter. Please select 'YES'.



WARNING:

Please note that, once you select 'YES', all power will be completely cut off. Please make sure that the critical loads connected to the UPS have already been safely shut down before you perform the turn-off procedures.

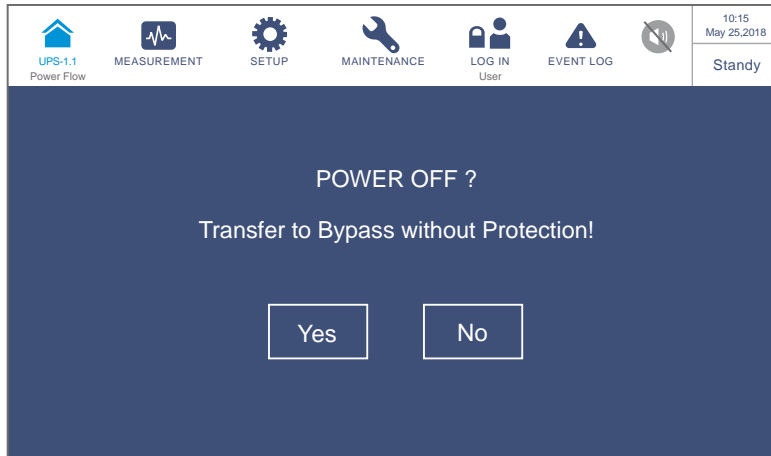

(Figure 6-58: Power off Reminder Screen)

- 3) After selection of 'YES', the UPS will shut down the inverter and terminate each power module's output. As there is no bypass output in Frequency Conversion mode, all output will be terminated right after the inverter is shut down. Now, each power module keeps charging the batteries, the tri-color LED indicator illuminates yellow and the following screen appears (Figure 6-59). For the tri-color LED indicator location, please refer to Figure 2-11.

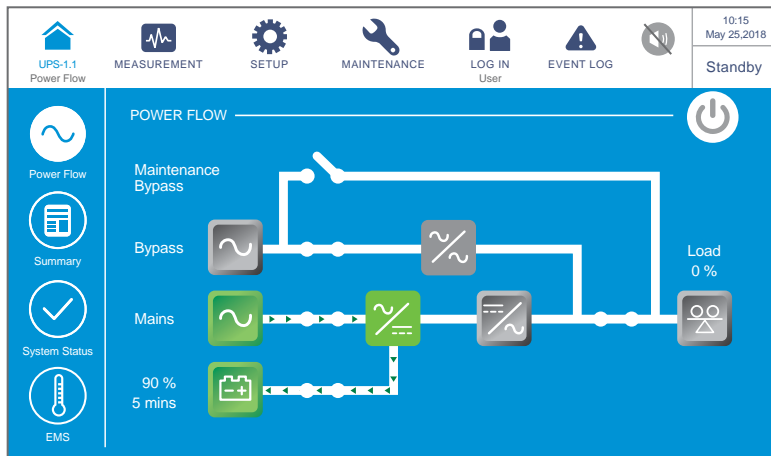

(Figure 6-59: Standby Mode Screen)

- 4 Switch **OFF** the Output Breaker (Q4) and log in as an **Administrator**. For the **Administrator** password, please contact service personnel. After login, ensure that you are in the **Administrator** login status (see **Figure 6-60**).

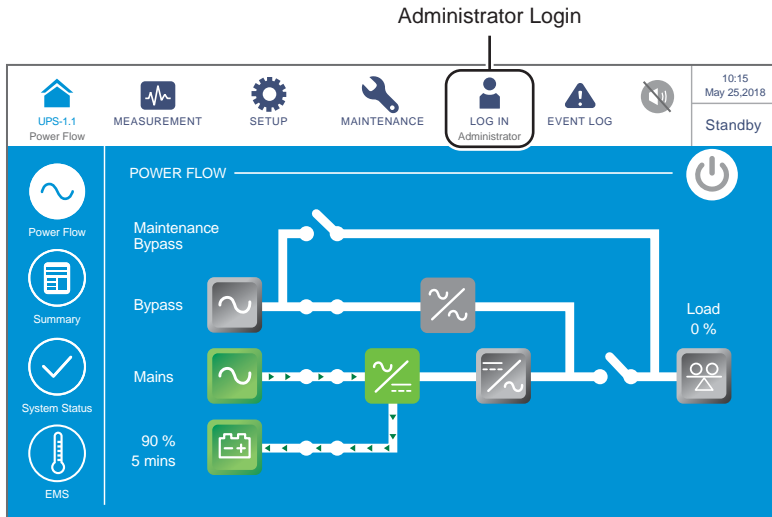

(Figure 6-60: Standby Mode Screen_ Administrator Login)

- 5 Go to **SETUP** → **Mode Setting** → **On-Line**. If the bypass voltage is in the normal range, the UPS will run in Bypass mode to let the bypass AC source supply power to the output.

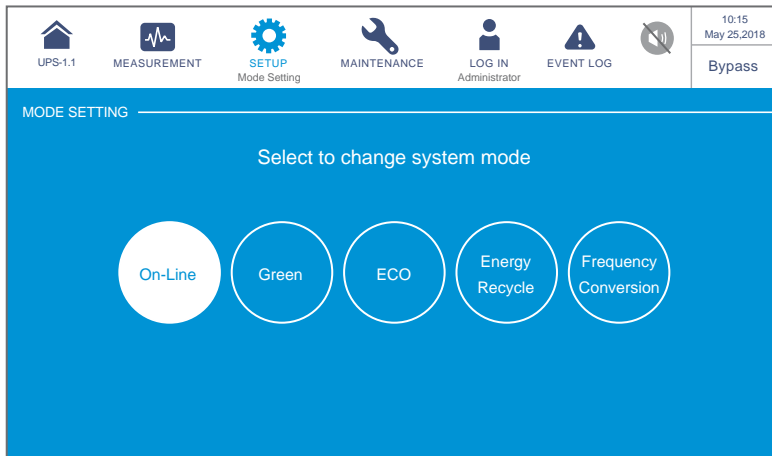

(Figure 6-61: Select Online Mode)

- 6 Switch **OFF** the Input Breaker (Q1) and Bypass Breaker (Q2).
- 7 Now, each power module performs DC BUS discharging and its LED indicator flashes green. After discharging, each power module's LED indicator will be off.

- 8) About 3 minutes later, the UPS will shut down, and the LCD and the tri-color LED indicator will be off.
- 9) Switch **OFF** every external battery cabinet's breaker (Q5).

6.3.7 Green Mode Turn-off Procedures

- 1) In Green mode, the LCD shows the following screen (**Figure 6-62**) and the tri-color LED indicator illuminates green. For the tri-color LED indicator location, please refer to **Figure 2-11**.

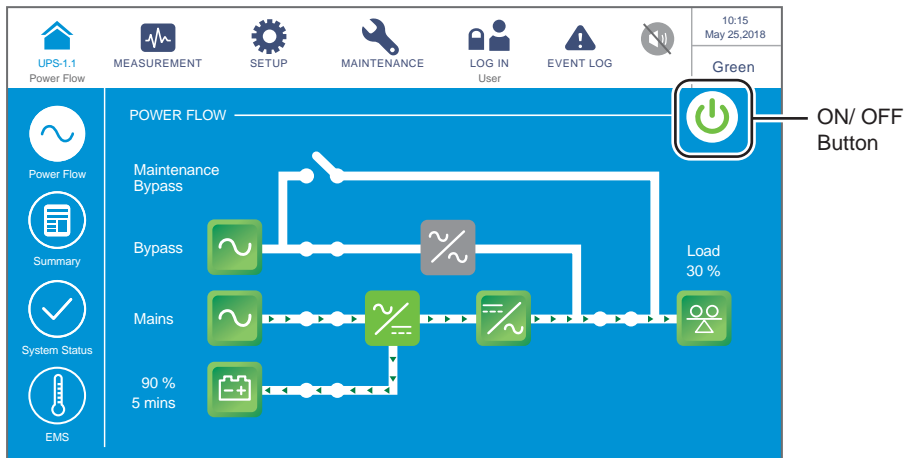

(Figure 6-62: Green Mode Screen & ON/ OFF Button Location)

- 2) Tap the ON/ OFF Button () and the following screen will pop up to ask if you want to power off the UPS's inverter. Please select 'YES'.

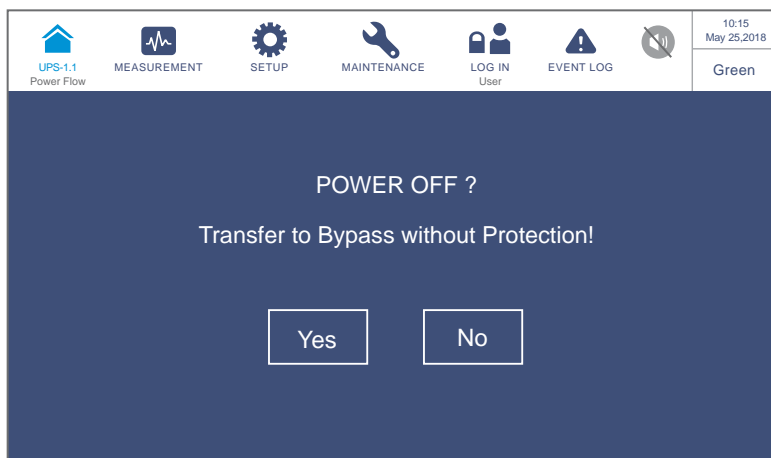

(Figure 6-63: Power off Reminder Screen)

- 3 After selection of 'YES', the UPS will shut down each power module's output and let the bypass AC source supply power. If the bypass AC source is abnormal, there is a risk of output interruption and the connected critical loads won't be protected. At this moment, each power module keeps charging the batteries, the tri-color LED indicator illuminates yellow and the following screen appears (**Figure 6-64**). For the tri-color LED indicator location, please refer to **Figure 2-11**.

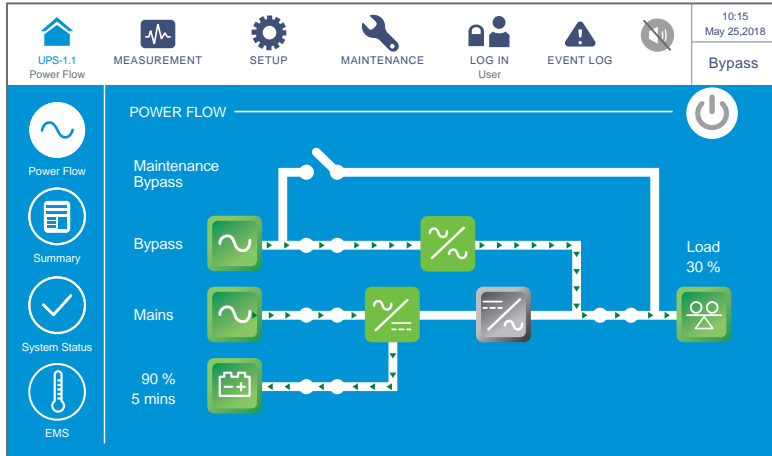

(Figure 6-64: Bypass Mode Screen)

- 4 Please log in as an **Administrator**. For the **Administrator** password, please contact service personnel. After login, ensure that you are in the **Administrator** login status (see **Figure 6-65**).

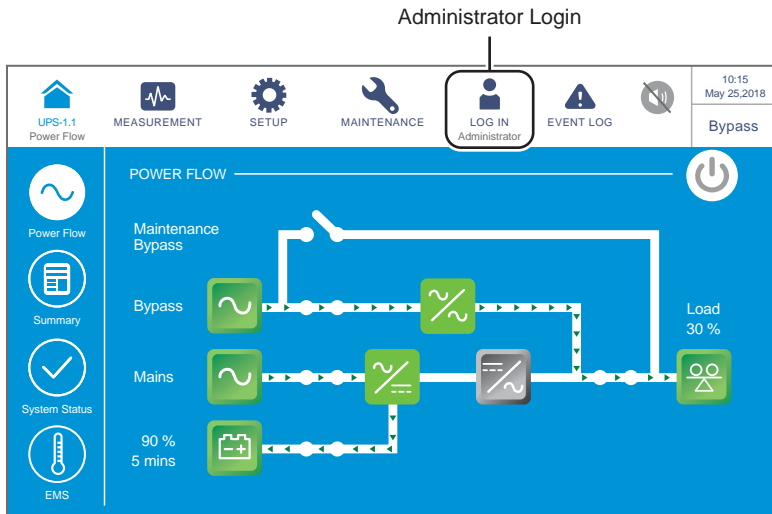

(Figure 6-65: Bypass Mode Screen_ Administrator Login)

- 5 Go to **SETUP** → **Mode Setting** → **On-Line**.

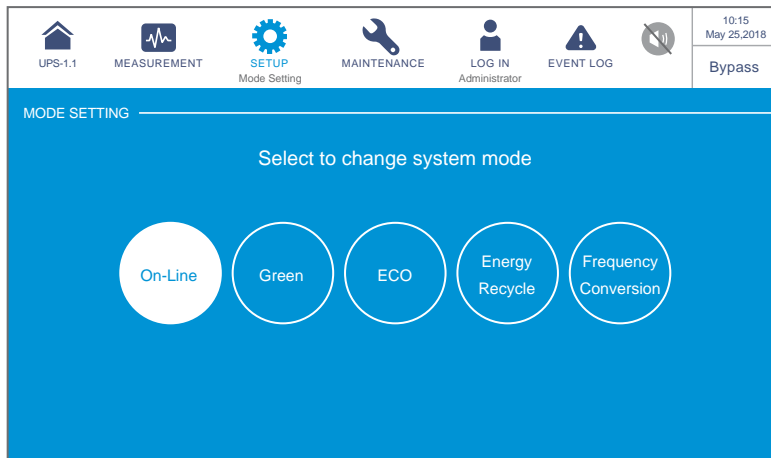

(Figure 6-66: Select On-Line Mode)

- 6 Switch **OFF** the Input Breaker (Q1), Bypass Breaker (Q2) and Output Breaker (Q4). After that, the UPS will run in Standby mode.
- 7 Now, each power module performs DC BUS discharging and its LED indicator flashes green. After discharging, each power module's LED indicator will be off.
- 8 About 3 minutes later, the UPS will shut down, and the LCD and the tri-color LED indicator will be off.
- 9 Switch **OFF** every external battery cabinet's breaker (Q5).

6.3.8 Energy Recycle Mode Turn-off Procedures



WARNING: Energy Recycle mode is only applicable to single input and single unit application.

- 1 In Energy Recycle mode, the LCD shows the following screen (**Figure 6-67**) and the tri-color LED indicator illuminates yellow. For the tri-color LED indicator location, please refer to **Figure 2-11**.

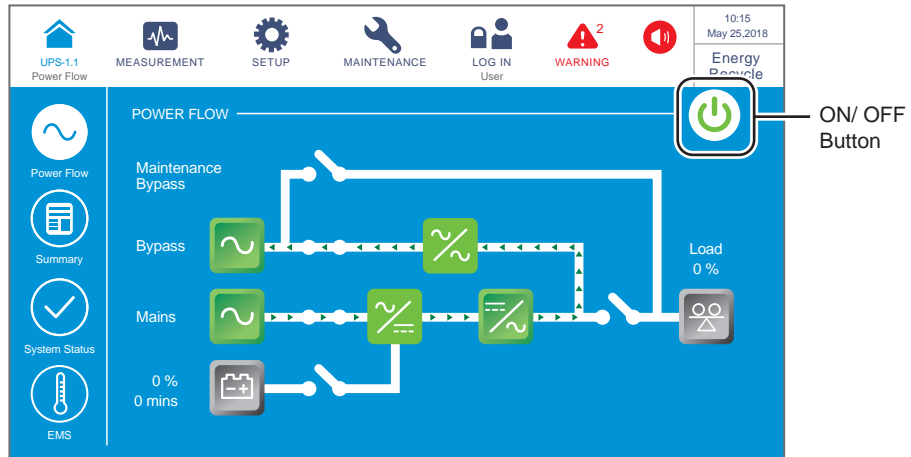

(Figure 6-67: Energy Recycle Mode Screen & ON/ OFF Button Location)

- 2 Tap the ON/ OFF Button (🔌) and the following screen will pop up to ask if you want to power off the UPS's inverter. Please select 'YES'.

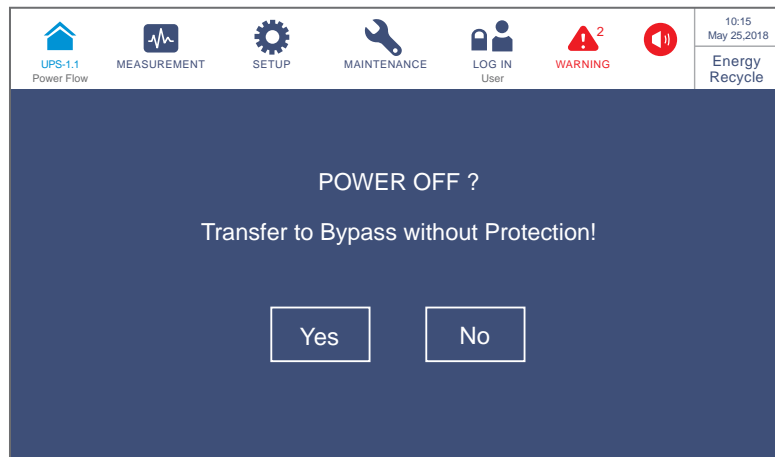

(Figure 6-68: Power off Reminder Screen)

- 3 After selection of 'YES', the UPS will stop self-aging test and transfer to run in Bypass mode. At this moment, the tri-color LED indicator illuminates yellow and the following screen appears (**Figure 6-69**). For the tri-color LED indicator location, please refer to **Figure 2-11**.

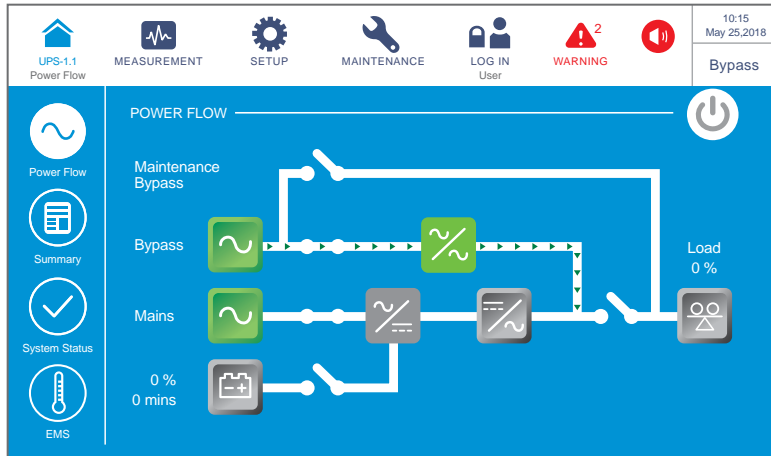

(Figure 6-69: Bypass Mode Screen)

- 4 Please log in as an **Administrator**. For the **Administrator** password, please contact service personnel. After login, ensure that you are in the **Administrator** login status (see **Figure 6-70**).

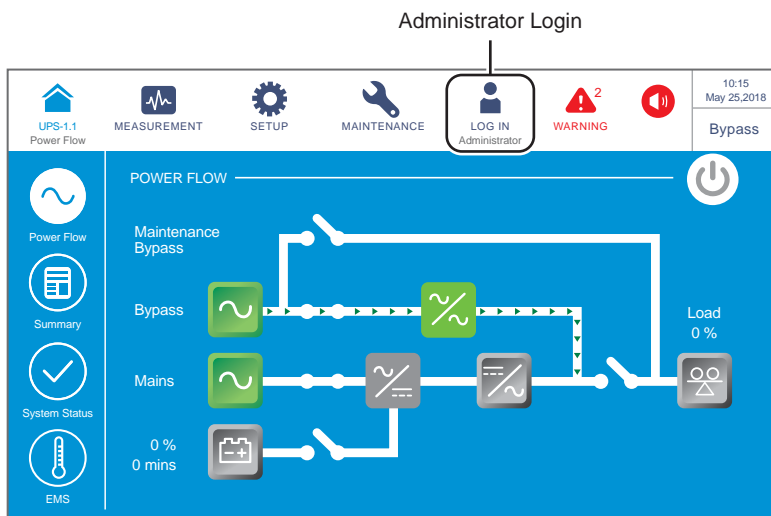

(Figure 6-70: Bypass Mode Screen_ Administrator Login)

5 Go to **SETUP** → **Mode Setting** → **On-Line**.

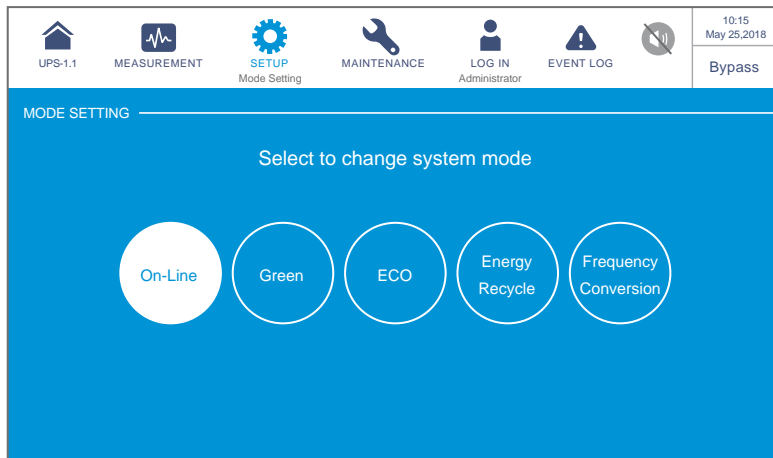

(Figure 6-71: Select Online Mode)

6 Switch **OFF** the Input Breaker (Q1) and Bypass Breaker (Q2).

7 The UPS will shut down, and then, the LCD and the tri-color LED indicator will be off.

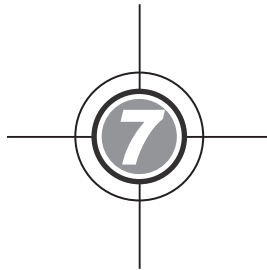

LCD Display & Settings

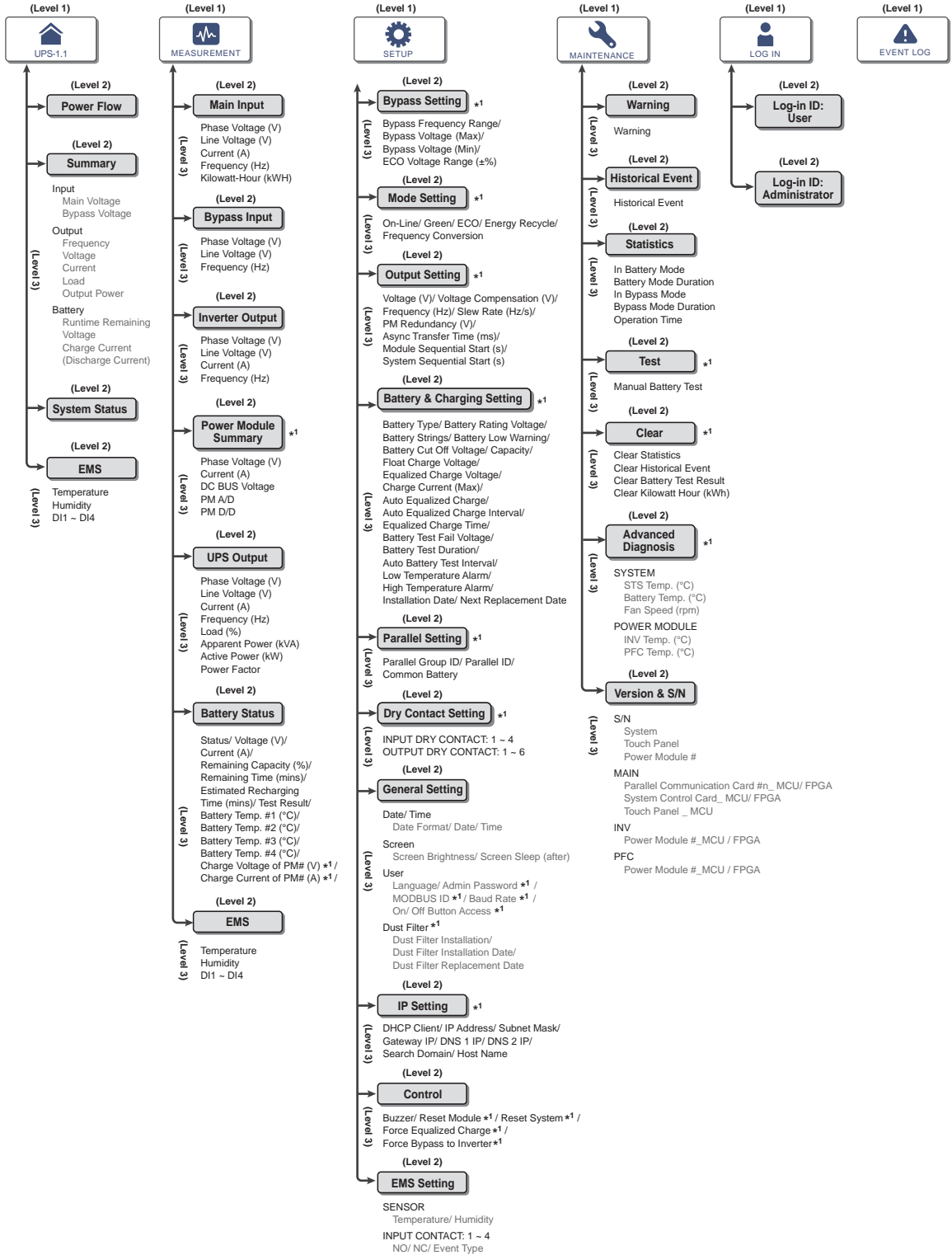

- 7.1 LCD Display Hierarchy
- 7.2 How to Turn on the LCD
- 7.3 ON/ OFF Button
- 7.4 Introduction of Touch Panel and Function Keys
- 7.5 Password Entry
- 7.6 Main Screen
- 7.7 Main Menu
- 7.8 Power Flow & Summary & System Status
- 7.9 Check System Readings
- 7.10 UPS Settings
- 7.11 System Maintenance

7.1 LCD Display Hierarchy



(Figure 7-1: LCD Display Hierarchy)

**NOTE:**

1. *1 means that the **Administrator** password is needed. For password information, please refer to **7.5 Password Entry**.
2. The information on the LCD screen presented in **7. LCD Display & Settings**, including the UPS operation mode, machine number, date, time, total number of alarms, load (%), battery remaining time, user login or administrator login, are for reference only. The actual screen of display depends on the operation situation.
3. To turn on the touch panel, please refer to **7.2 How to Turn on the LCD** and **7.3 ON/OFF Button**.
4. (1) The setting of the **On/ Off Button Access** is set as 'Any User' for all the **ON/ OFF Button** () presented in this user manual.
 (2) If you want to change the access setting for the **ON/ OFF Button** (), please go to  → **General Setting** → **User** → **On/ Off Button Access**. For relevant information, please refer to **7.10.7 General Setting**.

7.2 How to Turn on the LCD

To turn on the LCD, please follow the steps below:

1. Perform one of the options (a.~d.) below; after that, the LCD will be on and the LCD initial screen will appear.
 - a. Turn on the Input Breaker (Q1); or
 - b. Turn on the Bypass Breaker (Q2); or
 - c. Turn on the Input Breaker (Q1) and Bypass Breaker (Q2); or
 - d. Turn on the external battery cabinet's breaker (Q5), open the front door of the UPS, and press any of the battery start buttons (**Figure 7-2**) for 1 second and release it.

(UPS Front View with Door Open)

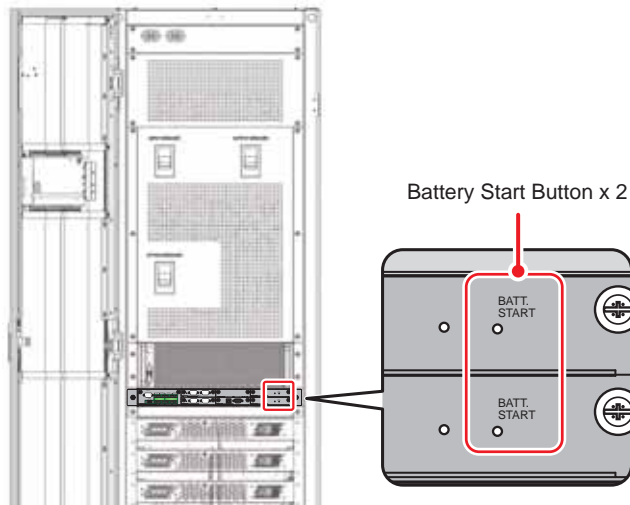

(Figure 7-2: The Position of Battery Start Buttons)



(Figure 7-3: LCD Initial Screen)

- 2) About 20 seconds after the LCD initial screen (see **Figure 7-3**) is on, the **Main Screen** will appear (see **Figure 7-4**). After you see the **Main Screen**, you can operate the LCD. Please note that the **Main Screen** appears in the **User** login status as shown in the figure below.

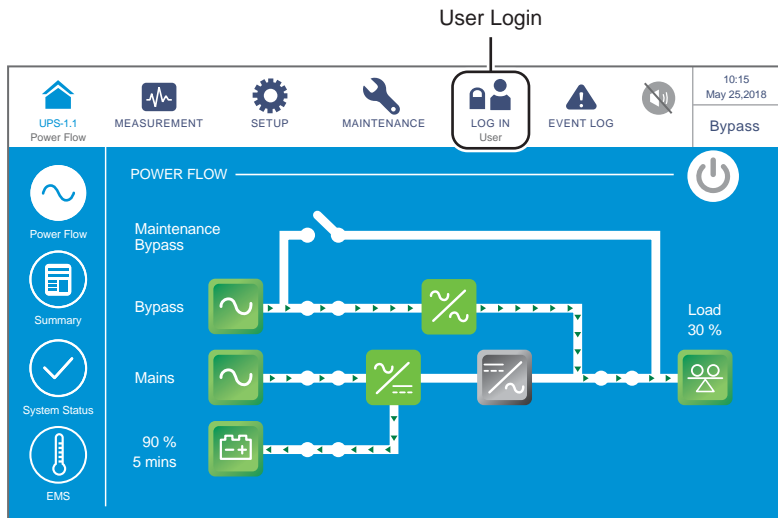





(Figure 7-4: Main Screen_ User Login)

7.3 ON/ OFF Button



NOTE:

1. The setting of the **On/ Off Button Access** is set as 'Any User' for all the **ON/ OFF Button** () presented in this user manual.
2. If you want to change the access setting for the **ON/ OFF Button** (), please go to  → **General Setting** → **User** → **On/ Off Button Access**. For relevant information, please refer to **7.10.7 General Setting**.

After the touch panel is turned on in accordance with the steps stated in **7.2 How to Turn on the LCD**, the **Main Screen** will appear in the **User** login status and the **ON/ OFF Button** () shown in **Figure 7-5** will appear.

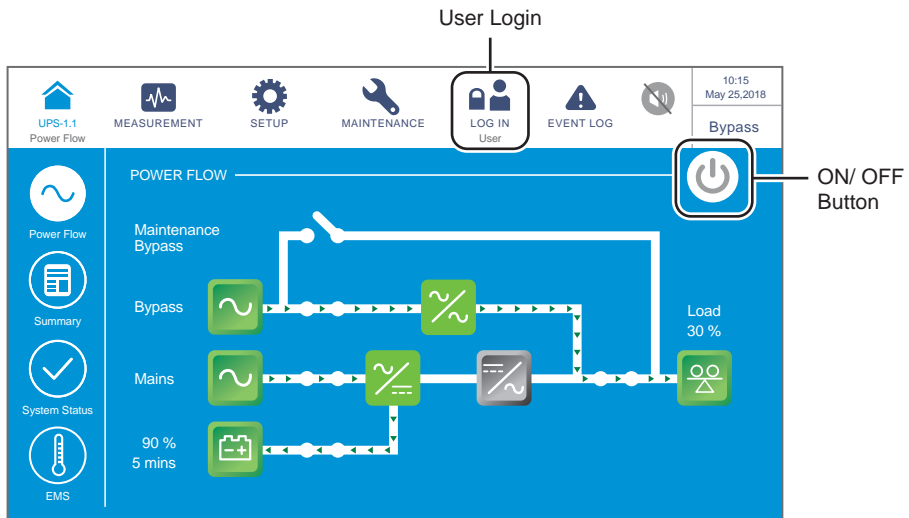

(Figure 7-5: Main Screen_ User Login & ON/ OFF Button Location)

• Power On

When the ON/ OFF Button is gray (), it indicates that the UPS's inverter is in the **OFF** status. Tap the button once and a reminder window shown below will pop up to ask for confirmation of '**POWER ON**'.

After selection of '**Yes**', the ON/ OFF Button will turn green (), indicating that the power-on process is completed.

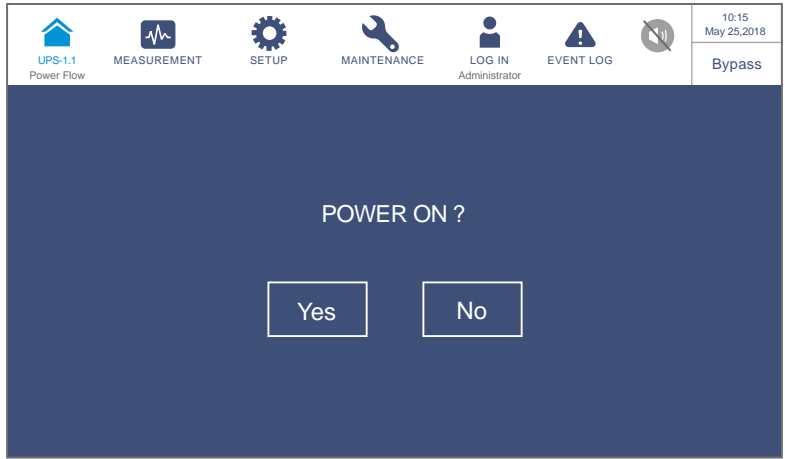

(Figure 7-6: Power On Reminder Window)

- **Power Off**

When the ON/ OFF Button is green (🔌), it indicates that the UPS's inverter is in the **ON** status. Tap the button once and a reminder window shown below will pop up to ask for confirmation of '**POWER OFF**'.

After selection of '**Yes**', the ON/ OFF Button will turn gray (🔌), indicating that the power-off process is completed.

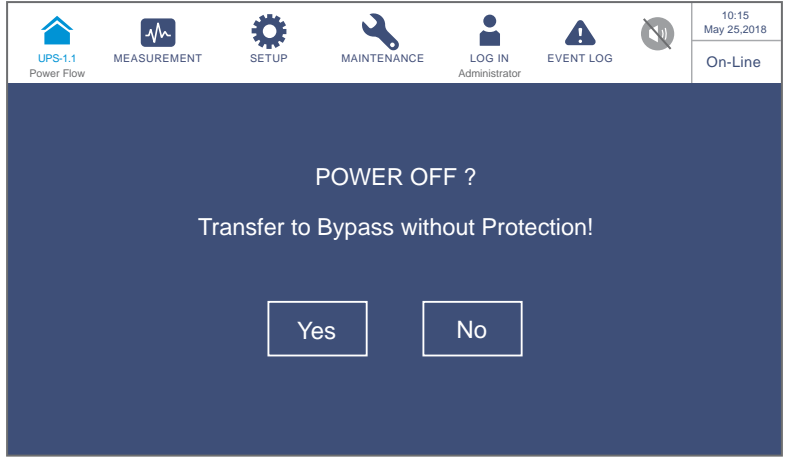





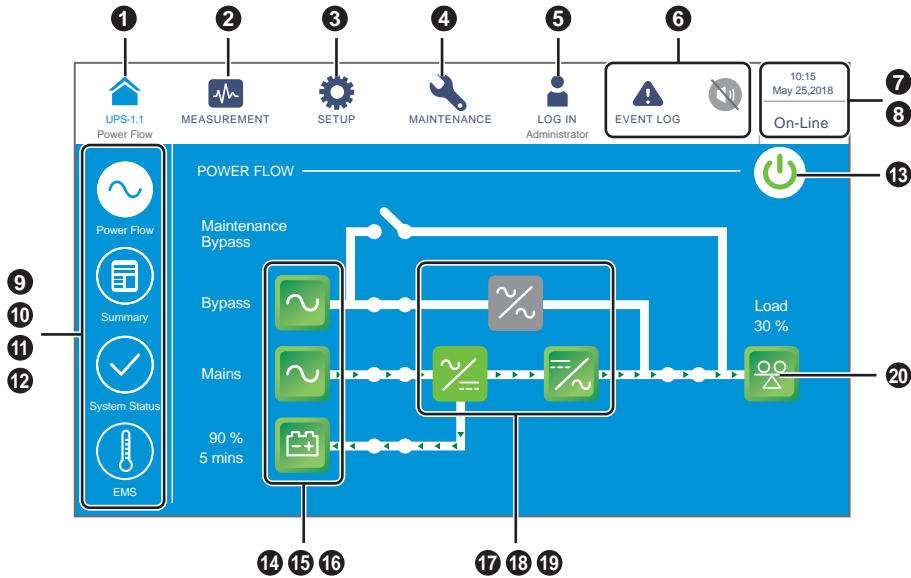















(Figure 7-7: Power Off Reminder Window)





7.4 Introduction of Touch Panel and Function Keys











(Figure 7-8: Introduction of Touch Panel and Function Keys)



















No.	Icon/ Text	Button Function (Yes or No)	Text/ Digital Display (Yes or No)	Symbol Display (Yes or No)	Description
1	 UPS-1.1	✓	✓		Back to the Main Screen . The (UPS-1.1) below the icon () indicates the parallel group ID (the former number) and the parallel ID (the latter number) of the UPS; see Figure 6-12 .  NOTE: For the parallel UPSs (at maximum four), if you tap the master UPS's icon (), you can check the master UPS's every status and reading and also all the other slave UPSs' partial status and partial readings. If you tap the slave UPS's icon (), you can only check the slave UPS's every status and reading.
2	 MEASUREMENT	✓			Shortcut icon for the measurement menu. For more information, please refer to 7.9 Check System Readings .

No.	Icon/ Text	Button Function (Yes or No)	Text/ Digital Display (Yes or No)	Symbol Display (Yes or No)	Description
3	 SETUP	✓			Shortcut icon for the setup menu. For more information, please refer to 7.10 UPS Settings .
4	 MAINTENANCE	✓			Shortcut icon for the maintenance menu. For more information, please refer to 7.11 System Maintenance .
5	 LOG IN User	✓		✓	Indicates login by User . Tap the icon to change the login permission. For more information, please refer to 7.5 Password Entry .
	 LOG IN Administrator	✓		✓	Indicates login by Administrator . Tap the icon to change the login permission. For more information, please refer to 7.5 Password Entry .
6	 EVENT LOG	✓		✓	<ol style="list-style-type: none"> 1. Event log shortcut icon (). Tap the icon to check all the event logs. 2. When the warning icon () is blue, it indicates that there is no warning.
		✓	✓	✓	<ol style="list-style-type: none"> 1. Warning event shortcut icon (). 2. Buzzer icon (). 3. When the warning icon () is red, it indicates that there is a warning. At this time, the buzzer will sound and the buzzer icon () will appear and light up. The numerical value at the upper right of the red warning icon indicates the total number of warning events. By tapping the buzzer icon (), the buzzer will be muted. At this time, the buzzer disabled icon () will appear. If there is any warning event afterwards, the buzzer will sound and the buzzer icon () will appear and light up again.
7	09:30 May 10,2018		✓		Indicates the time and date.

No.	Icon/ Text	Button Function (Yes or No)	Text/ Digital Display (Yes or No)	Symbol Display (Yes or No)	Description
8	On-Line ECO Frequency Conversion Green Energy Recycle Bypass Battery Standby Softstart		✓		Indicates the UPS's current operation status (the actual display depends on the actual operation status).
9		✓			Shortcut icon for the power flow diagram. Tap the icon to check the operation mode and status of the UPS. For more information, please refer to 7.8 Power Flow, Summary, System Status & EMS .
10		✓			Shortcut icon for summary information. Tap the icon to check the input, output, and battery status of the UPS. For more information, please refer to 7.8 Power Flow, Summary, System Status & EMS .
11		✓			Shortcut icon for system status. Tap the icon to check the status of each power module, parallel communication card, system control card, and auxiliary power card. For more information, please refer to 7.8 Power Flow, Summary, System Status & EMS .
12		✓			Shortcut icon for EMS information. On the EMS screen, you can check the integrated status of each optional EMS 1000 (EnviroProbe) device connected to the UPS (Green: Normal; Yellow: Warning; Red: Alarm; Gray: Off); the integrated status is determined by the most severe status among the device's temperature (°C) status, humidity (%) status, and the status of input contacts DI1~DI4. Please refer to 7.8 Power Flow, Summary, System Status & EMS .

No.	Icon/ Text	Button Function (Yes or No)	Text/ Digital Display (Yes or No)	Symbol Display (Yes or No)	Description
13		✓		✓	ON/ OFF Button. For more information, please refer to 7.3 ON/ OFF Button .
14	Bypass 	✓		✓	1. Bypass input status (Green: Normal; Red: Abnormal or OFF). 2. Bypass input screen shortcut icon.
15	Mains 	✓		✓	1. Main input status (Green: Normal; Red: Abnormal or OFF). 2. Main input screen shortcut icon.
16	90 % 5 mins 	✓	✓	✓	1. Battery status (Green: Normal; Flashing Green & Gray: Battery Mode ; Flashing Red & Gray: Battery Not Connected). 2. Battery remaining capacity (%). 3. Battery remaining time (minutes). 4. Battery status screen shortcut icon.
17				✓	Bypass static switch status (Green: ON ; Gray: Abnormal or OFF).
18				✓	Rectifier status (Green: Normal; Gray: Waiting or OFF).
19		✓		✓	1. Inverter status (Green: Normal; Gray: Waiting or OFF). 2. Inverter output screen shortcut icon.
20	Load 30 % 	✓	✓	✓	1. Output status (Green: Normal; Gray: No Output). 2. Load capacity (%). 3. UPS output screen shortcut icon.

Other icons on the touch panel are shown in the table below.

No.	Icon	Function
1		Goes to the top page.
		
2		Goes to the last page.
3		Moves up.
		
4		Moves down.
		
5		Goes to the previous page.
		
6		Goes to the next page.
		
7		Increases number.
8		Decreases number.
9		1. Indicates the page No. 2. Choose to go to a specific page No.
10		Deletes number(s) / word(s).
		
11		Capital
12		Space



NOTE:

1. After the back light is turned off, you can tap the LCD to return to the **Main Screen**. For information about the **Main Screen**, please refer to **7.6 Main Screen**.
2. The sleep time for the back light can be adjusted. Please refer to **7.10.7 General Setting**.
3. If you are logged in as an **Administrator** (the **Administrator** password is required; please refer to **7.5 Password Entry**), you will be logged out when the backlight is off. Tap to wake up the LCD screen, and it will go back to the **Main Screen** in the **User** login status. Even if you set up the backlight in '**Never Sleep**' mode, you will still be logged out after the screen is idle for 5 minutes.
4. The default language is English. To change the displayed language of the screen, please go to  → **General Setting** → **User** → **Language**. The default language will be different according to different countries.

7.5 Password Entry

1. Password entry is only required for login as an **Administrator**. **User** login does not require a password.
2. Tap  → enter the **Administrator** password (please contact service personnel for the default password) → the icon  appears, indicating the **Administrator** login is successful.
3. To change the **Administrator** password, please go to  → **General Setting** → **User** → **Administrator Password** (4 digits).



NOTE:

Different login IDs (Administrator/ User) have different access to different screens, inspection items and setup items. Please refer to **7.1 LCD Display Hierarchy**.

7.6 Main Screen

1. Please refer to **7.2 How to Turn on the LCD** and **7.3 ON/ OFF Button** to enter the **Main Screen**.
2. The system shows different power flow screens depending on the status of the UPS. Each power flow screen is a **Main Screen**. See the examples below.

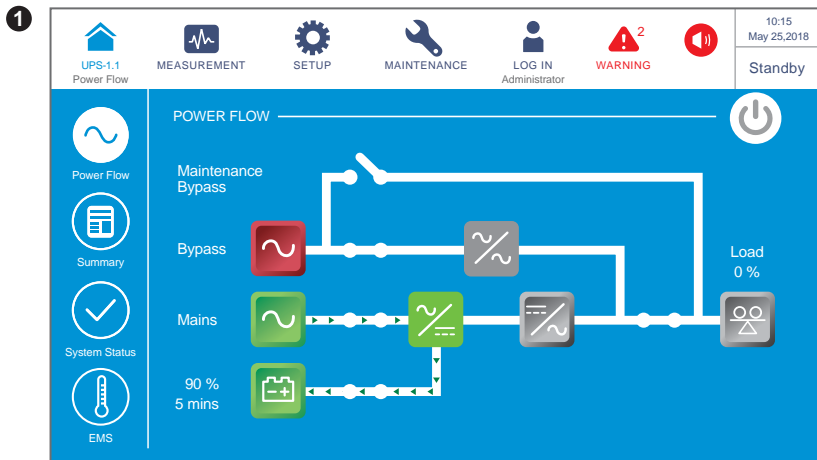

The screen above indicates that the UPS is in **Standby** mode. The inverter is off and the bypass input is out of the range.

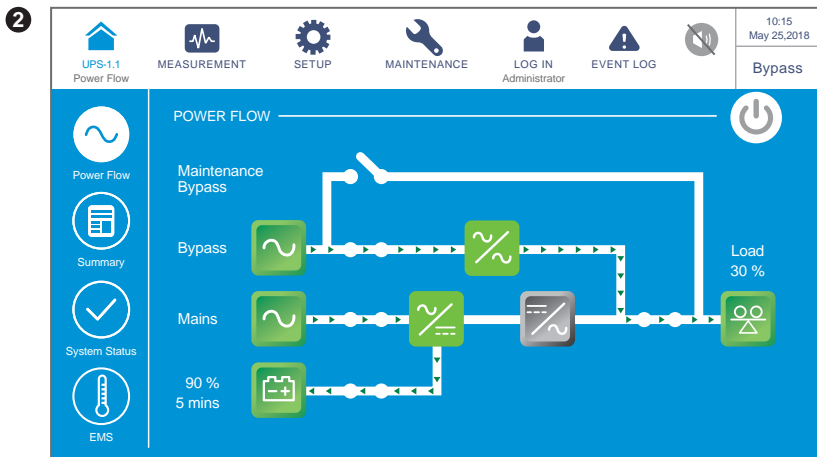

The screen above indicates that the UPS is in **Bypass** mode and the inverter is off.

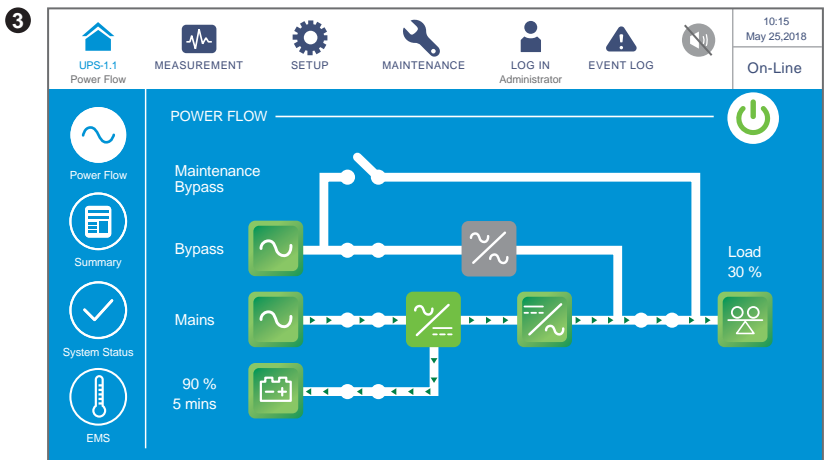

The screen above indicates that the UPS is in **On-Line** mode, and power supply of the loads comes from the inverter. Please refer to **7.10.2 Mode Setting** and **6.2.1 Online Mode Start-up Procedures**.

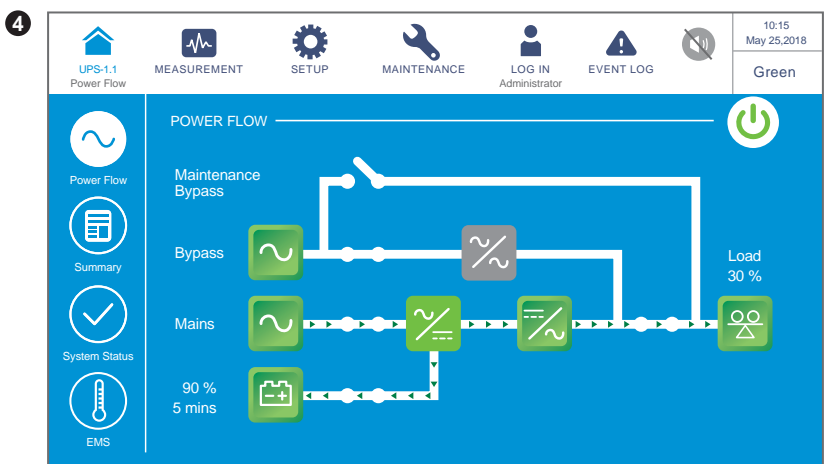

The screen above indicates that the UPS is in **Green** mode, and power supply of the loads comes from the inverter. Power modules will take turn to rest depending on the total load situation. For **Green** mode settings, please refer to **7.10.2 Mode Setting** and **6.2.7 Green Mode Start-up Procedures**.

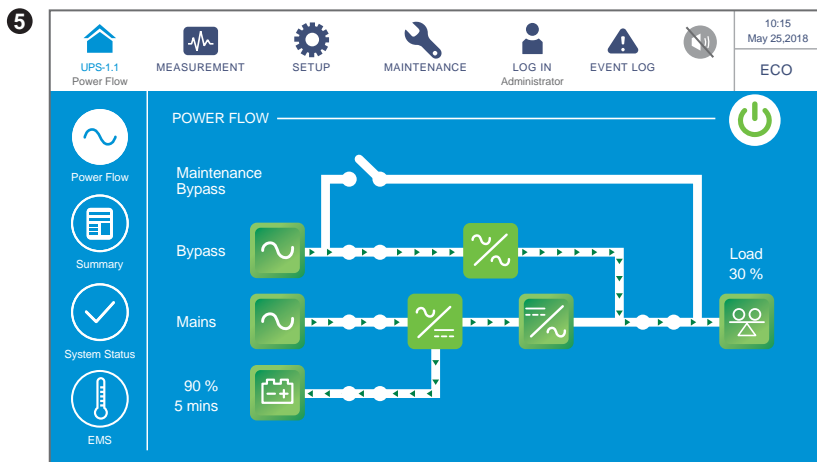

The screen above indicates that the UPS is in **ECO** mode. The inverter is in the ready-to-power-on status, and the power supply of the loads comes from the bypass. For **ECO** mode settings, please refer to **7.10.2 Mode Setting** and **6.2.5 ECO Mode Start-up Procedures**.

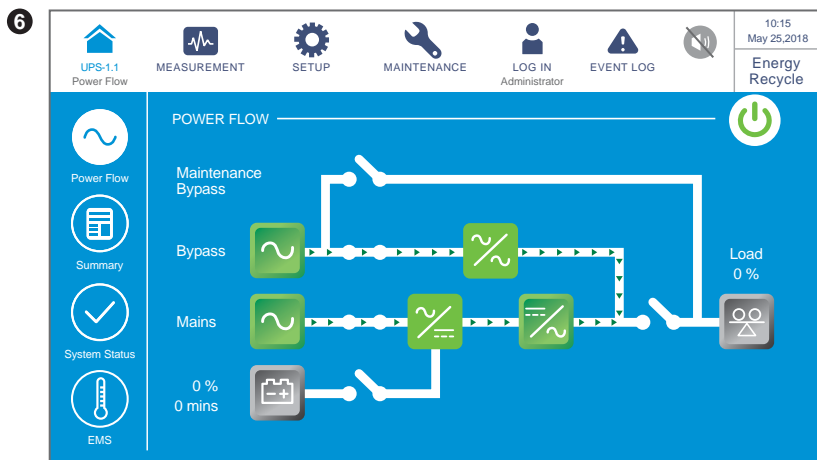

The screen above indicates that the UPS is in **Energy Recycle** mode. The output power will be recycled to the main input without being sent to the loads and the aging test could be conducted. For **Energy Recycle** mode settings, please refer to **7.10.2 Mode Setting** and **6.2.8 Energy Recycle Mode Start-up Procedures**.

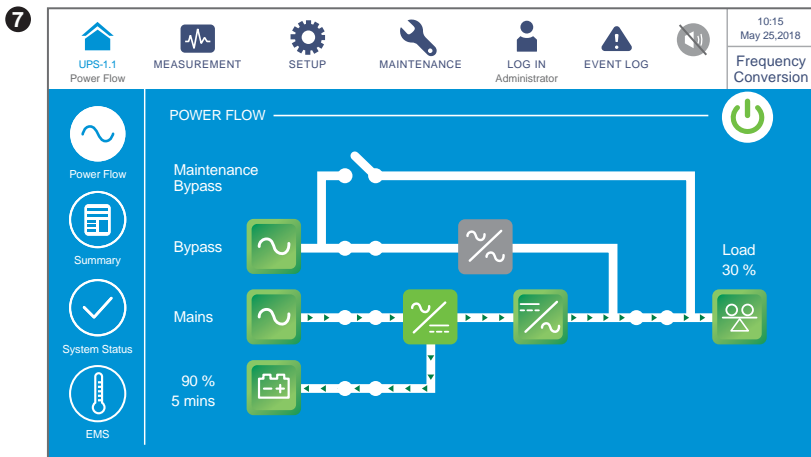

The screen above indicates that the UPS is in **Frequency Conversion** mode and the bypass output is restricted. For **Frequency Conversion** mode settings, please refer to **7.10.2 Mode Setting** and **6.2.6 Frequency Conversion Mode Start-up Procedures**.

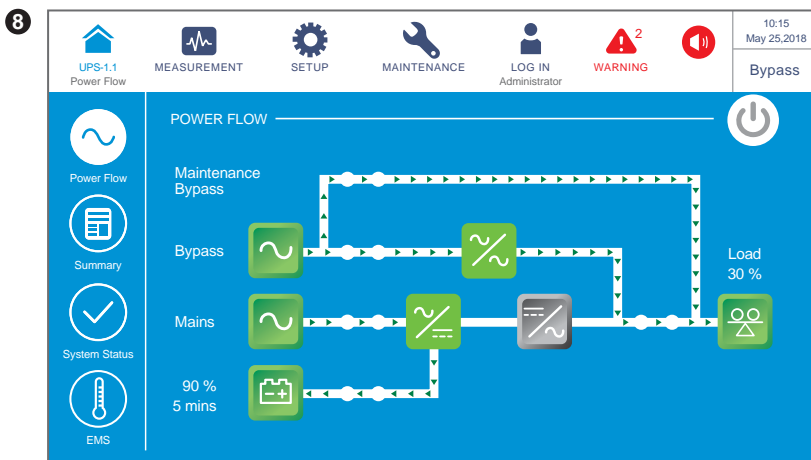



After the External Manual Bypass Breaker (Q3) is turned on, the UPS will be switched to **Manual Bypass** mode and the screen above will appear. Before maintenance, the UPS must be switched to this mode and it must be ensured that all input power, bypass power and battery power are disconnected. After power disconnection, the LCD will be off and the loads will not be protected. If there is any sudden malfunction in the bypass, the loads will lose power. Please refer to **6.2.4 Manual Bypass Mode Start-up Procedures**.

7.7 Main Menu

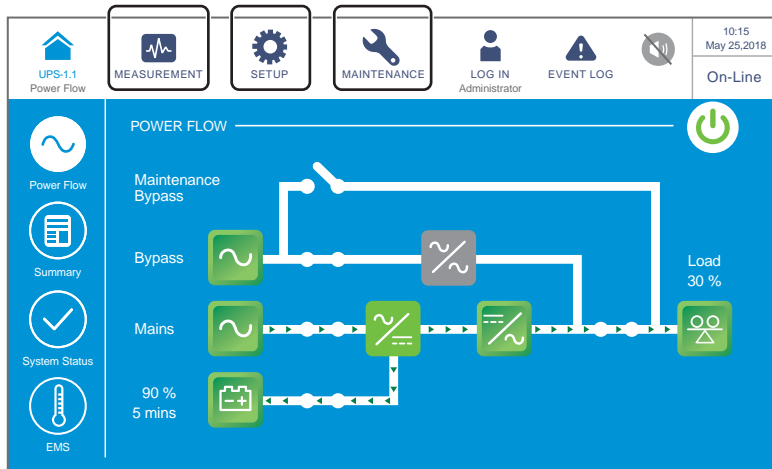
There are three main menu icons  ,  and  , and their positions are shown in the figure below.



Main Menu Icon	Description
 MEASUREMENT	Tap the icon to go to the Measurement Menu . In the menu, you can check the UPS's readings including the following: <ol style="list-style-type: none"> 1. Main Input 2. Bypass Input 3. Inverter Output 4. Power Module Summary 5. UPS Output 6. Battery Status 7. EMS For more information, please refer to 7.9 Check System Readings .
 SETUP	Tap the icon to go to the Setup Menu . In the menu, you can set up the following: <ol style="list-style-type: none"> 1. Bypass Setting 2. Mode Setting 3. Output Setting 4. Battery & Charging Setting 5. Parallel Setting 6. Dry Contact Setting 7. General Setting 8. IP Setting 9. Control 10. EMS Setting For more information, please refer to 7.10 UPS Settings .

Main Menu Icon	Description
 MAINTENANCE	<p>Tap the icon to go to the Maintenance Menu. In the menu, you can (1) check the warning events/ historical events/ statistics/ relevant temperature readings/ firmware versions, (2) execute the manual battery test, (3) clear the statistics/ historical events/ battery test result, and (4) upgrade firmware.</p> <p>In the Maintenance Menu, it includes the following items.</p> <ol style="list-style-type: none"> 1. Warning 2. Historical Event 3. Statistics 4. Test 5. Clear 6. Advanced Diagnosis 7. Version & S/N <p>For more information, please refer to 7.11 System Maintenance.</p>





NOTE:

Different login IDs (Administrator/ User) have different access to different screens, inspection items and setup items. Please refer to **7.1 LCD Display Hierarchy**.

7.8 Power Flow, Summary, System Status & EMS

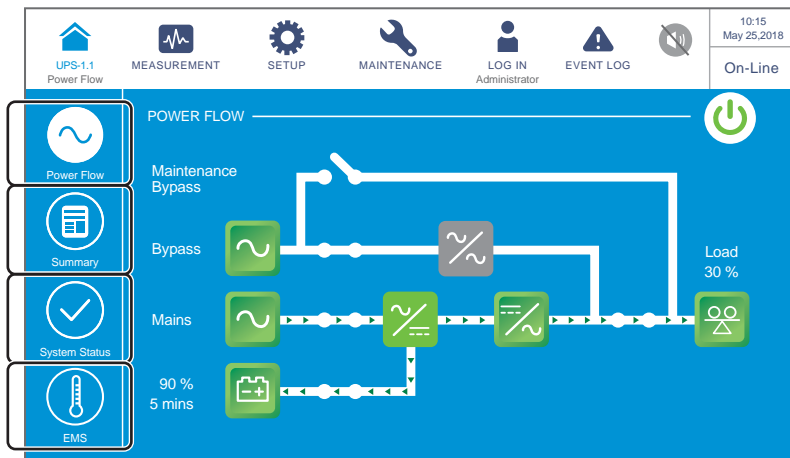
There are four shortcut icons for you to check the **Power Flow**, **Summary**, **System Status** and **EMS** respectively. Please see the figure below.



1. Tap the  icon to check the UPS's power flow diagram. Please refer to the figure below.

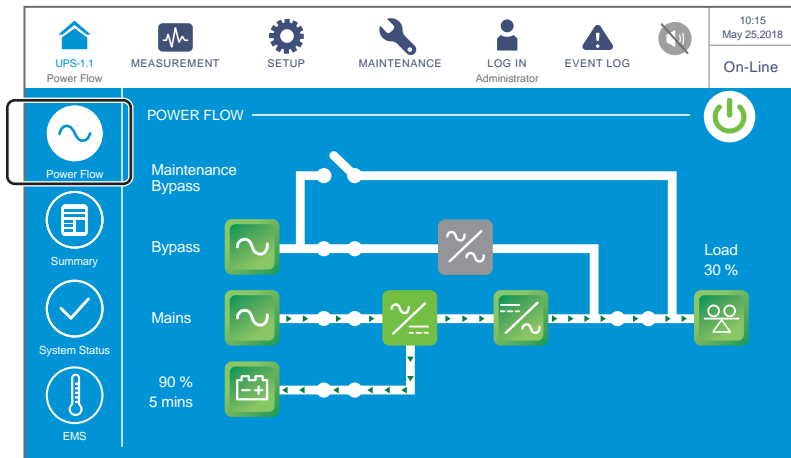

2. Tap the  icon to check information related to input, output and battery. Please refer to the figure below.



- Tap the  icon to check the status of the STS module, power modules, parallel communication cards, system control card and auxiliary power cards. Please refer to the figure below.

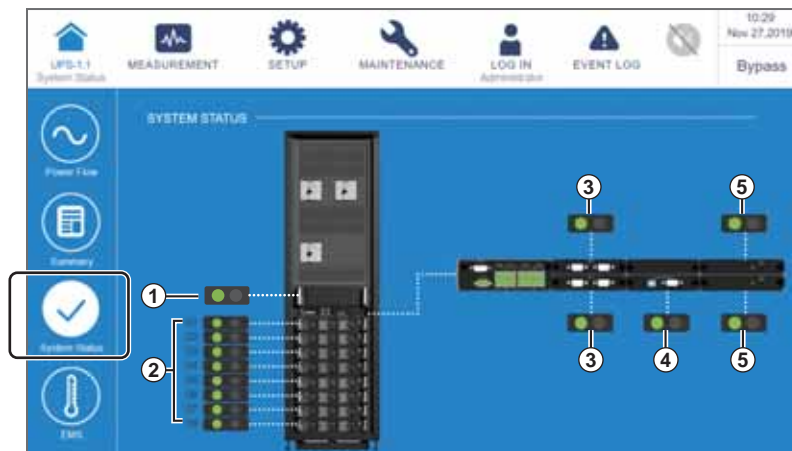

- ① STS Module Status
- ② Power Module Status
- ③ Parallel Communication Card Status
- ④ System Control Card Status
- ⑤ Auxiliary Power Card Status

- Tap the  icon to check the integrated status of each optional EMS 1000 (EnviroProbe) device connected to the UPS (Green: Normal; Yellow: Warning; Red: Alarm; Gray: Off); the integrated status is determined by the most severe status among the device's temperature (°C) status, humidity (%) status, and the status of input contacts DI1~DI4.

For more EMS information, please refer to **7.9.7 EMS** and **7.10.10 EMS Setting**.

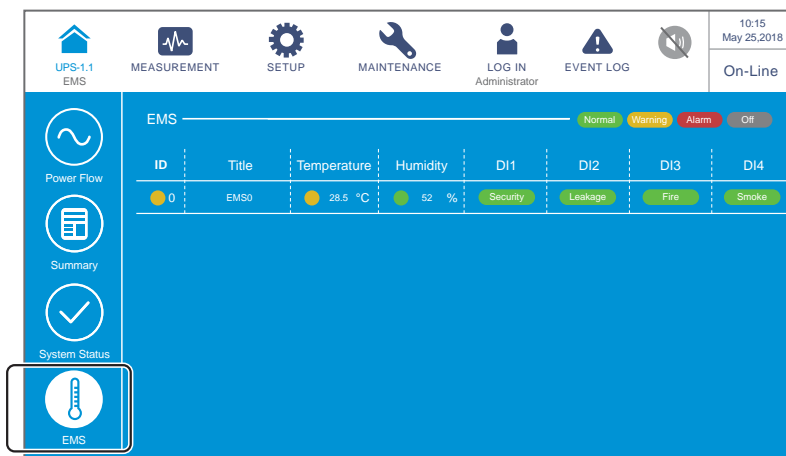

7.9 Check System Readings

7.9.1 Main Input

Path:  → Main Input

After entering the **MAIN INPUT** screen (shown in the figure below), you can view the readings of **Phase Voltage**, **Line Voltage**, **Current**, **Frequency** and **Kilowatt-Hour**.

For more information about Kilowatt-Hour, please refer to **7.9.1.1 Check Kilowatt-Hour**.



7.9.1.1 Check Kilowatt-Hour

Path:  → Main Input → kWh icon ()



Tap the KWH icon () , and you can check the kWh statistics of the UPS main input in the following window.

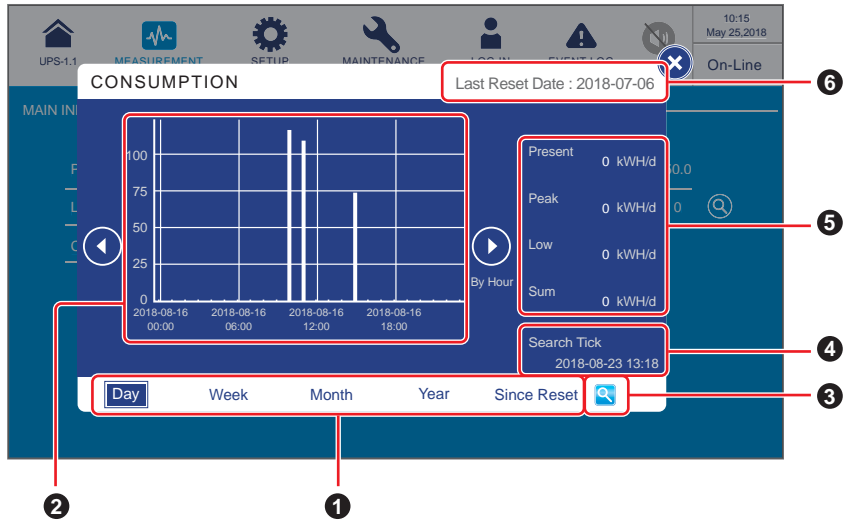

No.	Item	Description
①	kWH Statistics Sheet Tabs (Day/ Week/ Month/ Year/ Since Reset)	Tap the tabs of different sheets to view the kWH statistics and column chart of different time scales.
②	Column Chart	<ol style="list-style-type: none"> Shows the UPS's main input kWH statistics, with time on X-axis and kWH on Y-axis. Tap one of the columns on the chart and the corresponding piece of data will appear below the chart. Please refer to Page 7-23~7-30 for relevant information.
③	Search Tick Setup Icon	Tap the icon (🔍), and you can set the date and time for the 'Search Tick' to view the corresponding column chart. Please refer to Page 7-30~7-31 for relevant information.
④	Search Tick	Search Tick in the lower right corner of the window shows the date and time that has been set for you to view the specific column chart. Please refer to Page 7-30~7-31 for relevant information.
⑤	Present/ Peak/ Low/ Sum (kWH/d)	Shows today's statistics: the present value/ the highest value (so far)/ the lowest value (so far)/ the sum (so far). Regardless of different kWH statistics sheets, these four items only indicate today's statistics.
⑥	Last Reset Date	The last date when ' Clear Kilowatt Hour ' was executed. Please refer to 7.11.5 Clear for relevant information.

1. Descriptions of the **kWH Statistics Sheet Tabs**

- A. Tap the kWH statistics sheet tab (**Day**), and you can view the **daily** kWH statistics of the UPS main input **by hour**, as shown in the figure below.

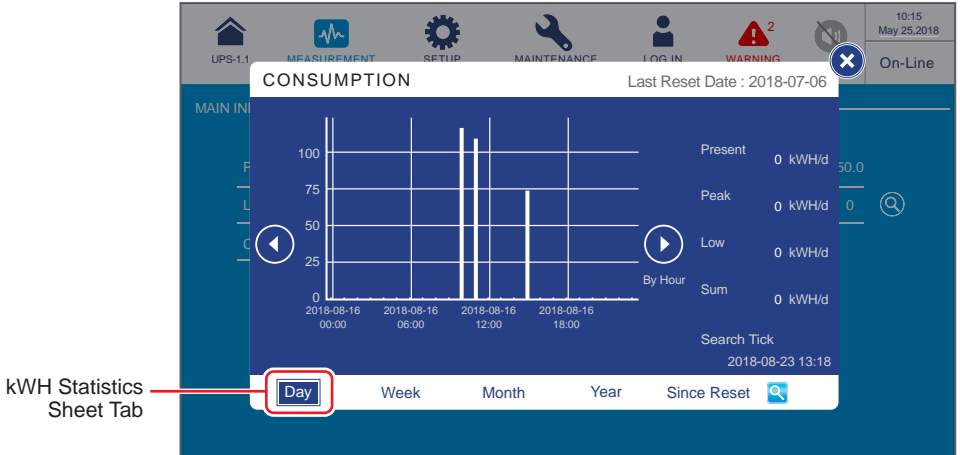

- **On the X-axis**

- (1) Minimum unit: one hour (a piece of data); interval: 6 hours.
- (2) Interval marks: 00:00/ 06:00/ 12:00/ 18:00 of the day.
- (3) 24 pieces of data (00:00~23:00) are shown in the column chart of the day.

- Tap the icon () on either side of the column chart to view the statistics of the previous/ next day.
- Tap one of the columns on the chart, and the corresponding piece of data will appear below the chart, as shown in the figure below.

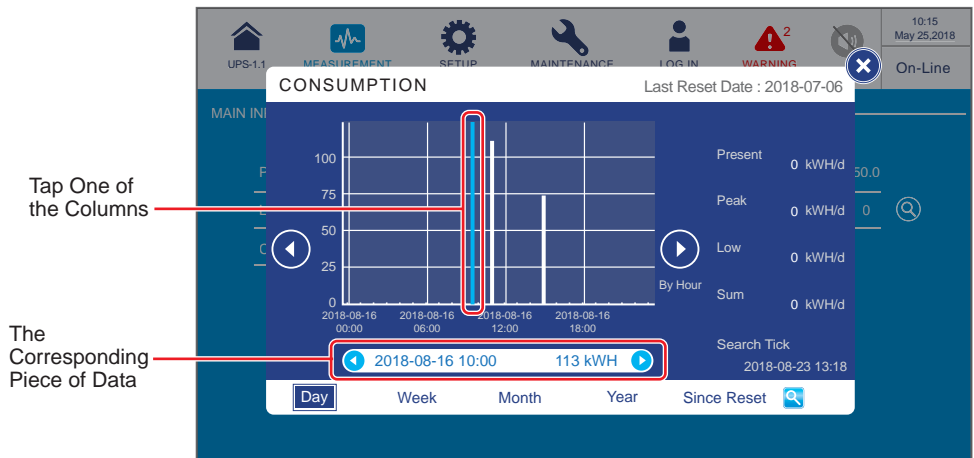

- (1) Take the figure above as an example; if you tap the column '2018-08-16 10:00', the data bar that shows the corresponding piece of data will appear below the chart and show the UPS's main input kWH statistics '113kWH' from 10:00~11:00 on that date.

Tap the icon (◀ ▶) on either side of the data bar, and you can view the statistics of the previous/ next hour.

- (2) At the moment of viewing, if it is still within the hour (the minimum unit), the window shows the current statistics and will keep updating.

For example, if you view the kWH statistics at 10:30 (still within the minimum unit of the hour 10:00~11:00), the statistics of the column shown on the chart is from 10:00~10:30, and will keep updating.

- B. Tap the kWH statistics sheet tab (Week), and you can view the **weekly** kWH statistics of the UPS main input **by hour**, as shown in the figure below.

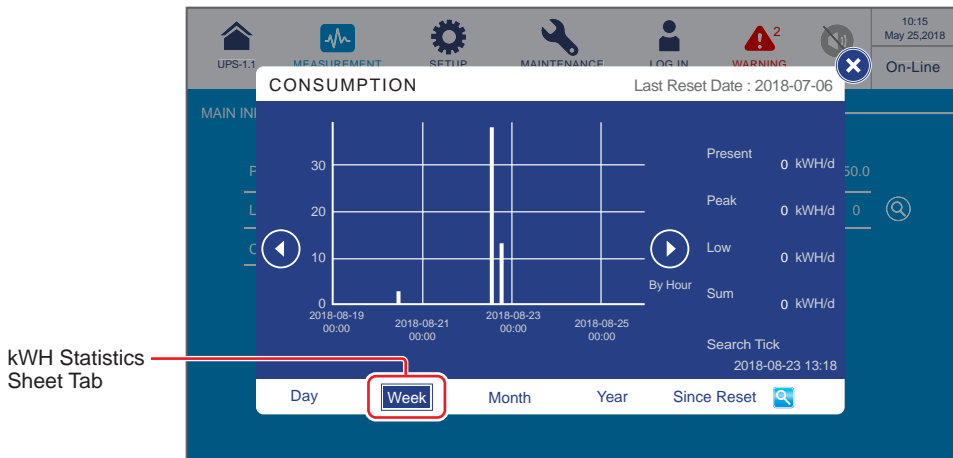

- **On the X-axis**

- (1) Minimum unit: one hour (a piece of data); interval: 24 × 2 hours.
- (2) Interval marks: Sun. 00:00/ Tue. 00:00/ Thur. 00:00/ Sat. 00:00 of the week.
- (3) 168 pieces of data (24 hours × 7 days) are shown in the column chart of the week.

- Tap the icon (◀ ▶) on either side of the column chart to view the statistics of the previous/ next week.
- Tap one of the columns on the chart, and the corresponding piece of data will appear below the chart, as shown in the figure below.

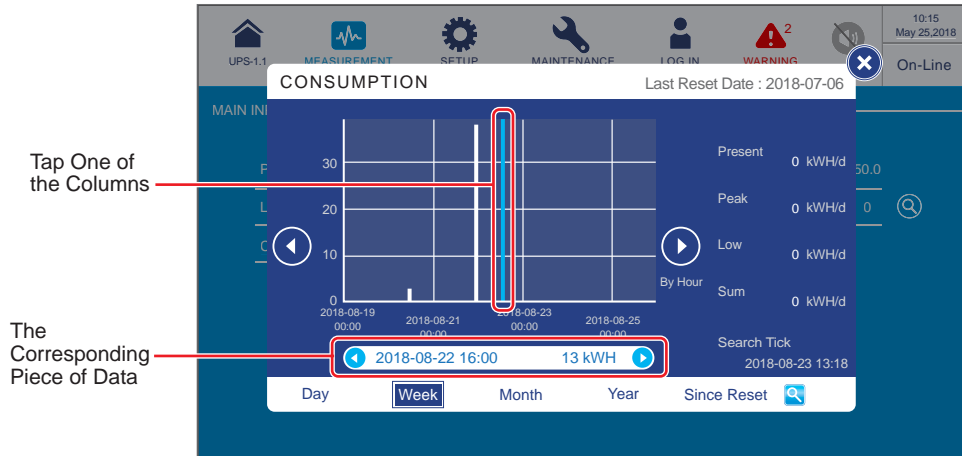

- (1) Take the figure above as an example; if you tap the column '2018-08-22 16:00', the data bar that shows the corresponding piece of data will appear below the chart and show the UPS's main input kWh statistics '13kWh' from 16:00~17:00 on that date.

Tap the icon (◀ ▶) on either side of the data bar, and you can view the statistics of the previous/ next hour.

- (2) At the moment of viewing, if it is still within the hour (the minimum unit), the window shows the current statistics and will keep updating.

For example, if you view the kWh statistics at 16:30 (still within the minimum unit of the hour 16:00~17:00), the statistics of the column shown on the chart is from 16:00~16:30, and will keep updating.

- C. Tap the kWh statistics sheet tab (**Month**), and you can view the **monthly** kWh statistics of the UPS main input **by day**, as shown in the figure below.

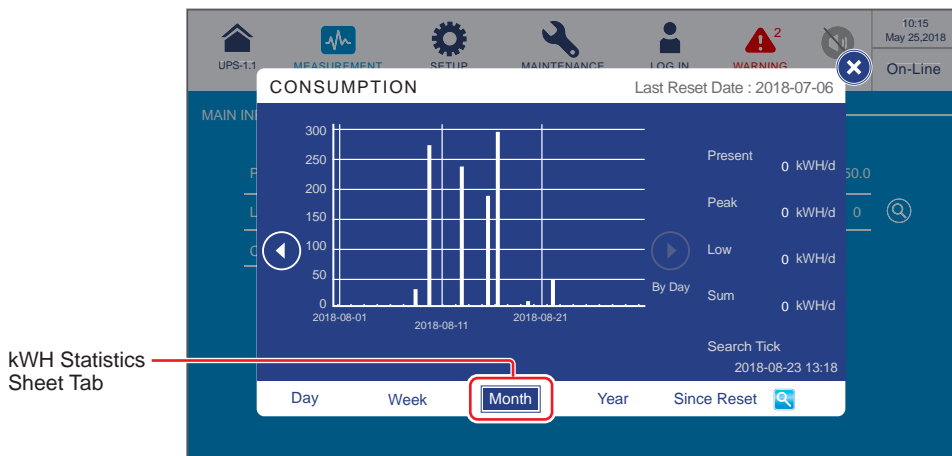

- **On the X-axis**

- (1) Minimum unit: one day (a piece of data); interval: 10 days.
- (2) Interval marks: 1st/ 11st/ 21st/ (31st) day of the month.
- (3) Pieces of data from the 1st day to the last day of the month (the total number of the days depends on the calendar) are shown in the column chart.

- Tap the icon (◀ ▶) on either side of the column chart to view the statistics of the previous/ next month.
- Tap one of the columns on the chart, and the corresponding piece of data will appear below the chart, as shown in the figure below.

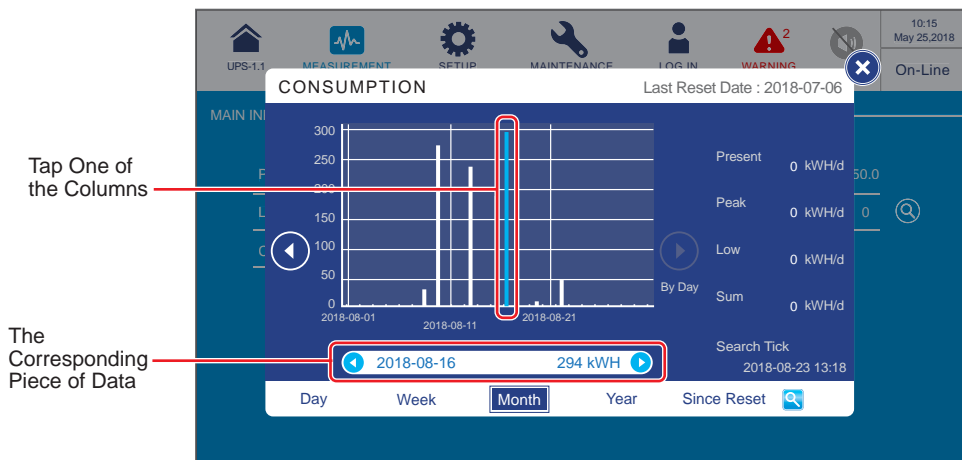

Tap One of the Columns

The Corresponding Piece of Data

- (1) Take the figure above as an example; if you tap the column '2018-08-16', the data bar that shows the corresponding piece of data will appear below the chart and show the UPS's main input kWH statistics '294kWH' of the day.

Tap the icon (◀ ▶) on either side of the data bar, and you can view the statistics of the previous/ next day.

- (2) At the moment of viewing, if it is still within the day (the minimum unit), the window shows the current statistics and will keep updating.

For example, if you view the kWH statistics on 2018-08-16 at 23:30 (still within the minimum unit of the day 2018-08-16), the statistics of the column shown on the chart is from 00:00~23:30, and will keep updating.

- D. Tap the kWH statistics sheet tab (Year), and you can view the **yearly** kWH statistics of the UPS main input **by week**, as shown in the figure below.

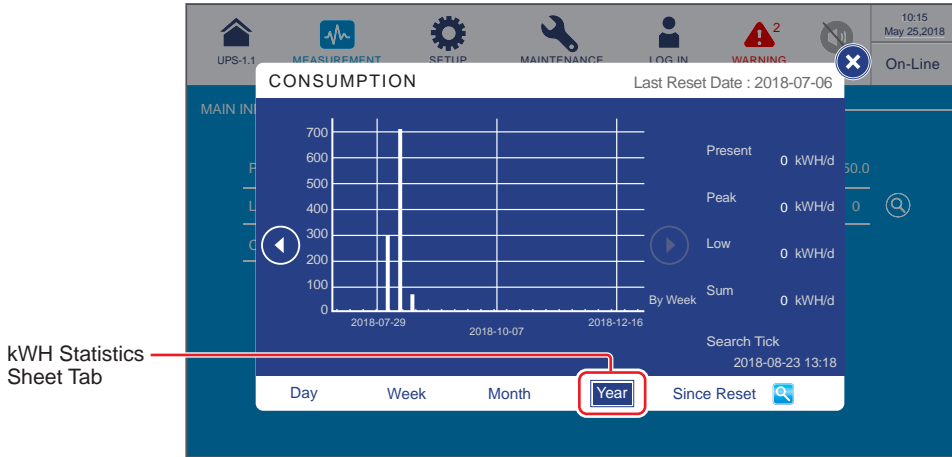

kWh Statistics Sheet Tab

• On the X-axis

- (1) Minimum unit: one week (a piece of data); interval: 10 weeks.
 - (2) Interval marks: (starting from Sunday) 1st week/ 11st week/ 21st week/ 31st week/ 41st week/ 51st week of the year.
 - (3) Pieces of data from the 1st Sunday to the last Sunday of the year (the total number of the weeks depends on the calendar) are shown in the column chart.
- Tap the icon (◀ ▶) on either side of the column chart to view the statistics of the previous/ next year.
 - Tap one of the columns on the chart, and the corresponding piece of data will appear below the chart, as shown in the figure below.

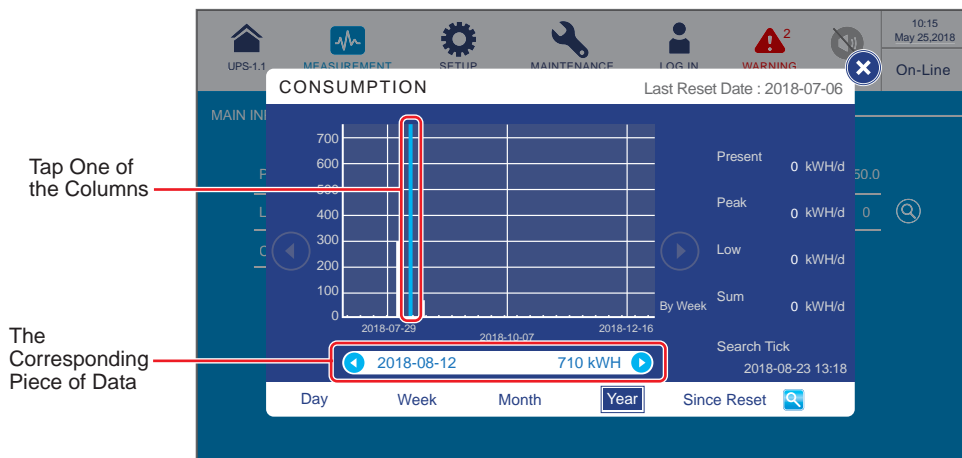

Tap One of the Columns

The Corresponding Piece of Data

- (1) Take the figure above as an example; if you tap the column '2018-08-12', the data bar that shows the corresponding piece of data will appear below the chart and show the UPS's main input kWh statistics '710kWH' of the week.

Tap the icon (◀ ▶) on either side of the data bar, and you can view the statistics of the previous/ next week.

- (2) At the moment of viewing, if it is still within the week (the minimum unit), the window shows the current statistics and will keep updating.

For example, if you view the kWh statistics on 2018-08-23 at 06:00 (still within the minimum unit of the week 2018-08-19 Sun.~2018-08-25 Sat.), the statistics of the column shown on the chart is from 2018-08-19 Sun. 00:00 ~ 2018-08-23 Thur. 06:00, and will keep updating.

- E. Tap the kWh statistics sheet tab (Since Reset), and you can view the kWh statistics of the UPS main input power since **Last Reset Date** (the last date when 'Clear Kilowatt Hour' was executed) **by month**, as shown in the figure below.

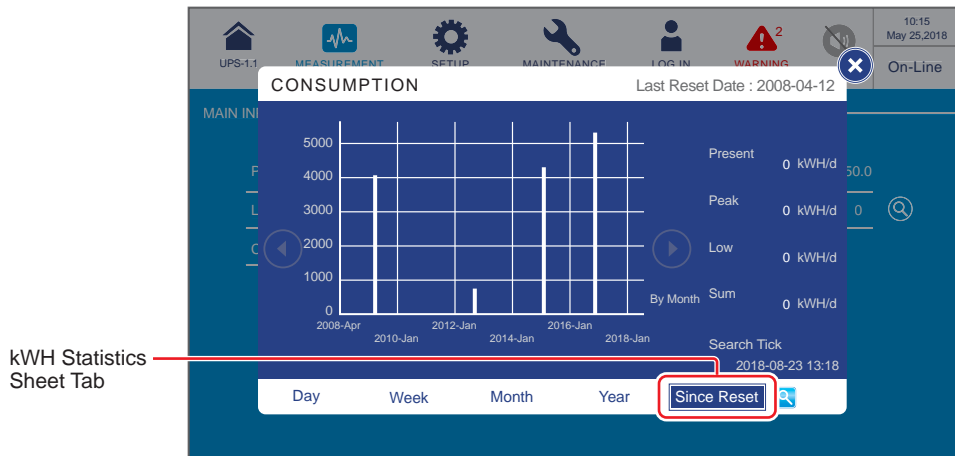

- **On the X-axis**

- (1) Minimum unit: one month (a piece of data); interval: 2 years.
- (2) Interval marks: Last Reset Date/ January of every two years (and so on).
- (3) Pieces of data lasting for 10 years since **Last Reset Date** are shown in the column chart. The system can save and show the statistics for up to 20 years.

- Tap the icon (◀ ▶) on either side of the column chart to view the statistics of the previous/ next 10 years.
- Tap one of the columns on the chart, and the corresponding piece of data will appear below the chart, as shown in the figure below.

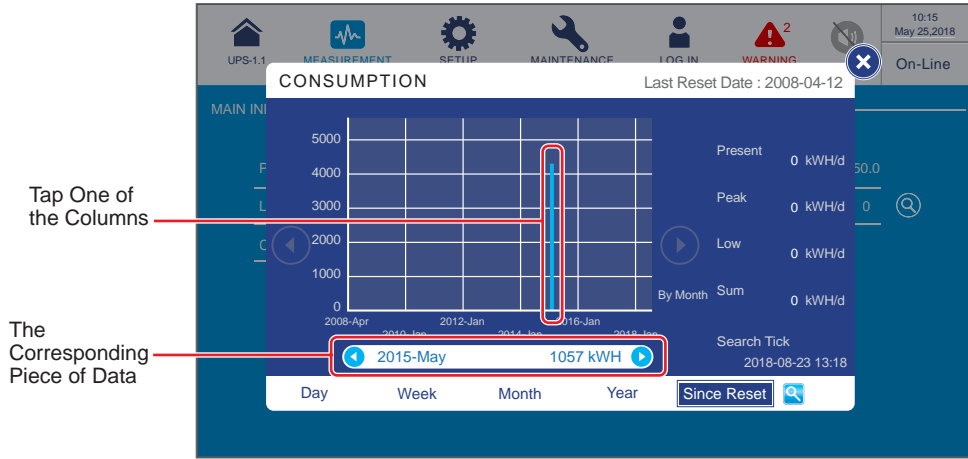

(1) Take the figure above as an example; if you tap the column '2015-May', the data bar that shows the corresponding piece of data will appear below the chart and show the UPS's main input kWH statistics '1057kWH' of the month.

Tap the icon (◀ ▶) on either side of the data bar, and you can view the statistics of the previous/ next month.

(2) At the moment of viewing, if it is still within the month (the minimum unit), the window shows the current statistics and will keep updating.

For example, if you view the kWH statistics on 2018-05-23 at 06:00 (still within the minimum unit of the month 2018-05-01~2018-05-31), the statistics of the column shown on the chart is from 2018-05-01 00:00~2018-05-23 06:00, and will keep updating.

2. Descriptions of Search Tick Setup Icon

If you want to check the UPS's main input kWH statistics of a specific date and time, tap the **Search Tick Setup Icon** (🔍) as shown in the figure below.

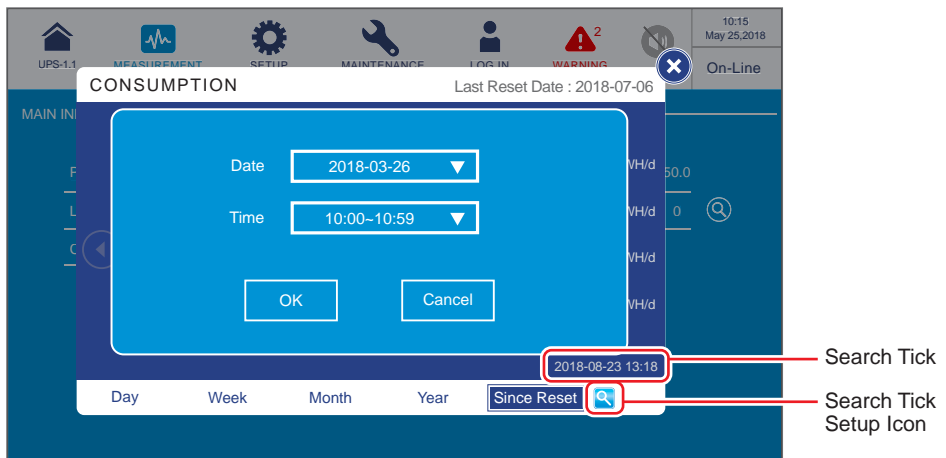

Tap 'OK' to complete the setup for Search Tick, and you will see the date and time in the lower right corner of the window. After that, select and tap one of the kWh Statistics Sheet Tabs to view the column chart of different time scales (Day/ Week/ Month/ Year/ Since Reset).

Take the above figure for example, the Search Tick has been set up as '2018-8-23 13:18'.

If you select (**Day**), you can view the column chart of the day (2018-8-23).

If you select (**Week**), you can view the column chart of the week (2018-08-19 Sun. ~ 2018-08-25 Sat.).

If you select (**Month**), you can view the column chart of the month (2018-08-01 ~ 2018-08-31).

If you select (**Year**), you can view the column chart of the year (2018-01-01~2018-12-31).

If you select (**Since Reset**), you can view the column chart of the 10 years since **Last Reset Date**.

3. If you want to download the UPS's main input kWh statistics, please follow the steps below.

- 1) Insert a USB flash drive to any of the USB ports shown in **Figure 4-17** and the download icon () will show up in the lower right corner of the window.

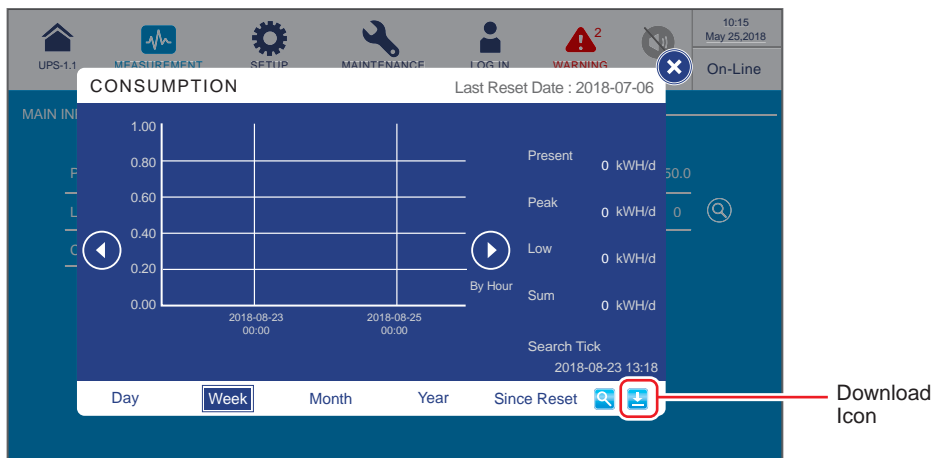

- 2) Tap one of the kWh Statistics Sheet Tabs to download the corresponding column chart and statistical data of a specific time scale (Day/ Week/ Month/ Year/ Since Reset).

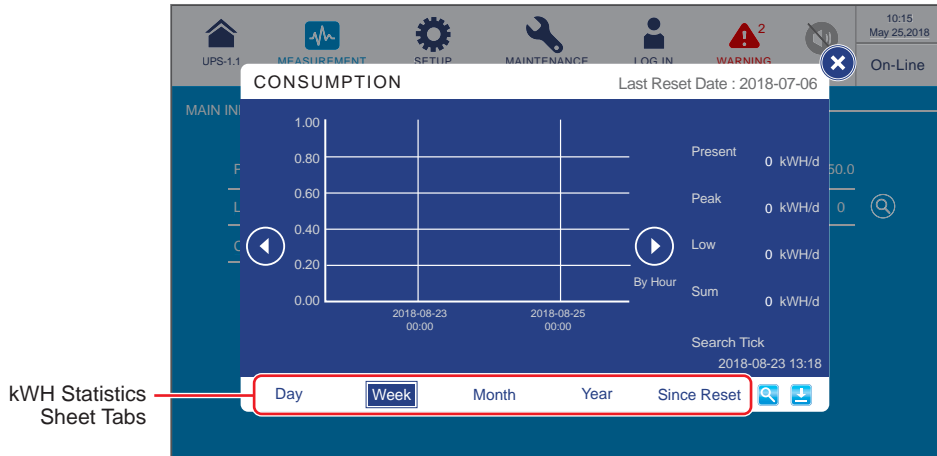

- 3 Tap the download icon () to start downloading, and the following screen will appear.

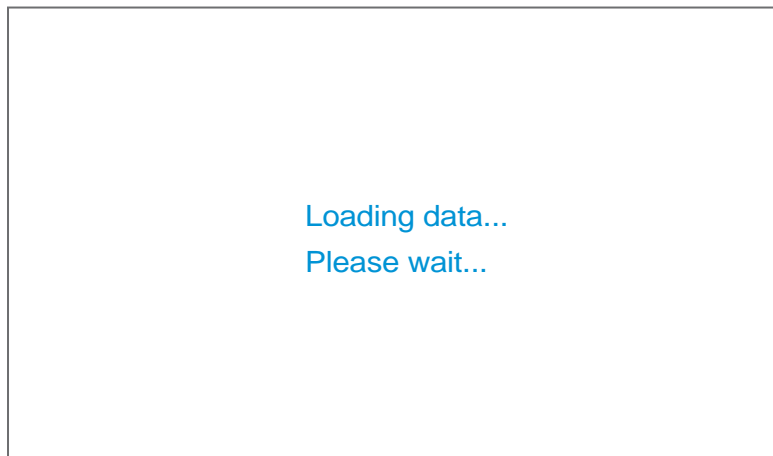

- 4 After the download has been completed, you will see the following screen.

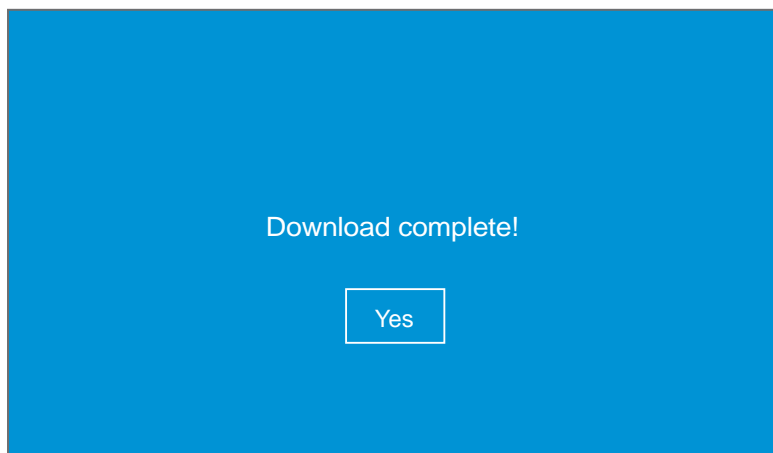

7.9.2 Bypass Input

Path:  → Bypass Input

After entering the **BYPASS INPUT** screen (shown in the figure below), you can view the readings of **Phase Voltage**, **Line Voltage** and **Frequency**.



7.9.3 Inverter Output

Path:  → Inverter Output

After entering the **INVERTER OUTPUT** screen (shown in the figure below), you can view each power module's **Phase Voltage**, **Line Voltage**, **Current** and **Frequency** readings.



7.9.4 Power Module Summary

Path:  → Power Module Summary

After entering the **POWER MODULE SUMMARY** screen*¹ (shown in the figure below), you can view each power module's **Phase Voltage**, **Current**, **DC BUS Voltage**, **PM A/D** and **PM D/D** readings.



NOTE: *¹ means that the **Administrator** password is needed. For password information, please refer to **7.5 Password Entry**.

UPS-L1	MEASUREMENT Power Module Summary	SETUP	MAINTENANCE	LOG IN Administrator	EVENT LOG	17:31 Nov 28, 2019 Bypass		
POWER MODULE SUMMARY								
Power Module #	1	2	3	4	5	6	7	8
Phase Voltage (V)	120.1	120.1	120.1	120.1	120.1	120.1	120.1	120.1
	120.1	120.1	120.1	120.1	120.1	120.1	120.1	120.1
	120.1	120.1	120.1	120.1	120.1	120.1	120.1	120.1
Current (A)	36.1	36.1	36.1	36.1	36.1	36.1	36.1	36.1
	36.2	36.2	36.2	36.2	36.2	36.2	36.2	36.2
DC BUS Voltage (V)	215.0	215.0	215.0	215.0	215.0	215.0	215.0	215.0
	215.0	215.0	215.0	215.0	215.0	215.0	215.0	215.0
PM A/D	On	On	On	On	On	On	On	On
PM D/D	Off	Off	Off	Off	Off	Off	Off	Off

7.9.5 UPS Output

Path:  → UPS Output

After entering the **UPS OUTPUT** screen (shown in the figure below), you can view the readings of **Phase Voltage**, **Line Voltage**, **Current**, **Frequency**, **Load**, **Apparent Power**, **Active Power** and **Power Factor**.

UPS-L1	MEASUREMENT UPS Output	SETUP	MAINTENANCE	LOG IN Administrator	EVENT LOG	17:24 Nov 28, 2019 Bypass	
UPS OUTPUT							
Phase Voltage (V)	120.2	120.2	120.2	Apparent Power (kVA)	59.9	60.0	60.0
Line Voltage (V)	208.2	208.2	208.2	Active Power (kW)	59.3	59.4	59.4
Current (A)	272.4	272.4	272.4	Power Factor	0.99	0.99	0.99
Frequency (Hz)	60.0						
Load (%)	30	30	30				

7.9.6 Battery Status

Path:  → **Battery Status**

After entering the **BATTERY STATUS** screen (shown in the figure below), you can view the readings of **Status**, **Voltage**, **Current**, **Remaining Capacity**, **Remaining Time**, **Estimated Recharging Time**, **Test Result**, **Battery Temperature (#1~#4)**, and each power module's **Charge Voltage***¹ and **Charge Current***¹.



NOTE: *¹ means that the **Administrator** password is needed. For password information, please refer to **7.5 Password Entry**.



7.9.7 EMS

Path 1: Tap the shortcut icon () on the **Main Screen**.

Path 2:  → **EMS**

To activate the EMS function of the UPS, you have to connect the optional EMS 1000 (EnviroProbe) device(s) with the UPS; the EMS information of each device (ID #) will be displayed on the **EMS** screen as shown in the figure below. Please refer to the table below for the descriptions of each item shown on the **EMS** screen.



NOTE:

1. The items shown on the **EMS** screen is related to the settings in the () → **EMS Setting**; the settings can be adjusted according to your needs.
2. For installation of the optional EMS 1000 (EnviroProbe), please refer to **7.9.7.1 Connecting the optional EMS 1000 (EnviroProbe)** and the **EnviroProbe 1000 Quick Guide** attached in the package of the optional EMS 1000 (EnviroProbe).

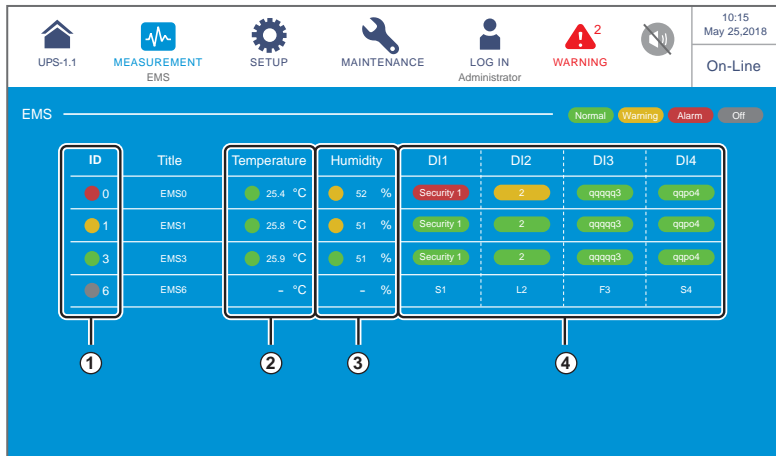

No.	Item	Color (Status)	Descriptions
①	ID	Green (Normal) Yellow (Warning) Red (Alarm) Gray (Off)	<ol style="list-style-type: none"> 1. Different ID # represents a different EMS 1000 (EnviroProbe) device connected to the UPS. <p> NOTE: The LCD will only show the EMS 1000 (EnviroProbe) devices (ID #) whose status have been set as 'Enable'. Please refer to 7.10.10 EMS Setting.</p> <ol style="list-style-type: none"> 2. Shows the integrated status of each EMS 1000 (EnviroProbe) device connected to the UPS. The integrated status is determined by the most severe status among the device's temperature (°C) status, humidity (%) status, and the status of input contacts DI1 ~ DI4.

No.	Item	Color (Status)	Descriptions
②	Temperature	Green (Normal) Yellow (Warning) Red (Alarm)	The color represents the status of Temperature/ Humidity based on the relevant settings. Please refer to 7.10.10 EMS Setting . When the detected Temperature/ Humidity: 1. is lower than the value set for Warning , it shows Green . 2. is higher than the value set for Warning but lower than the value set for Alarm , it shows Yellow . 3. is higher than the value set for Alarm , it shows Red .
③	Humidity	Green (Normal) Yellow (Warning) Red (Alarm)	4. has reached the value set for Alarm/ Warning , the status will recover from Alarm to Warning/ from Warning to Normal respectively only when the detected value has been lowered to its corresponding Recovery value.
④	DI1	Green (None/ Information)	1. Different colors represent different triggered status of each input contact. 2. The Title of input contacts DI1~DI4, NO/ NC setting, and Event Type can be adjusted according to your needs. Please refer to 7.10.10 EMS Setting .
	DI2		
	DI3	Yellow (Warning)	
	DI4	Red (Alarm)	

1. If the status of the EMS 1000 (EnviroProbe) device (ID #) is OFF (gray) as shown in the figure below, it means the communication of the device (ID #) is abnormal.

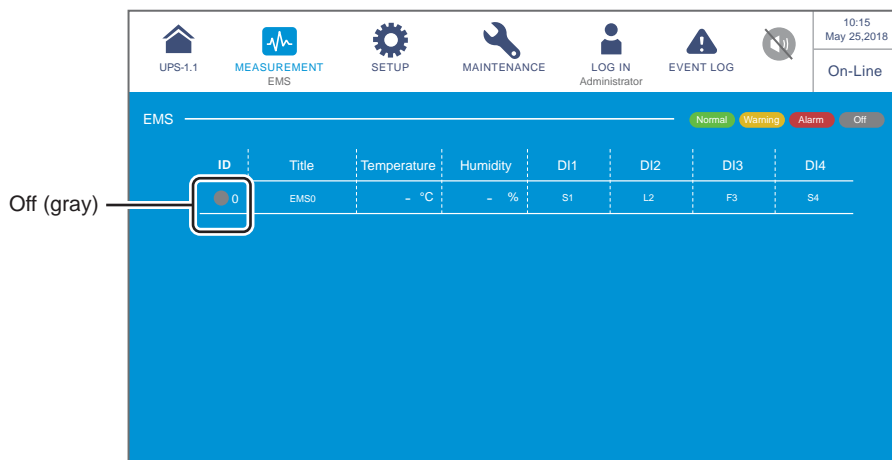

The reasons may be:

- (1) The status of the EMS 1000 (EnviroProbe) device (ID #) has been set as 'Enable' (please refer to **7.10.10 EMS Setting**), but the device (ID #) is not connected to the UPS or the connection cable may be damaged.
- (2) The ID # setting is wrong. Please refer to **7.10.10 EMS Setting**.

At this time, the warning message 'The EMS 1000 ID # Communication Fail' shown in the figure below will appear. For solutions, please refer to **10. Troubleshooting**.

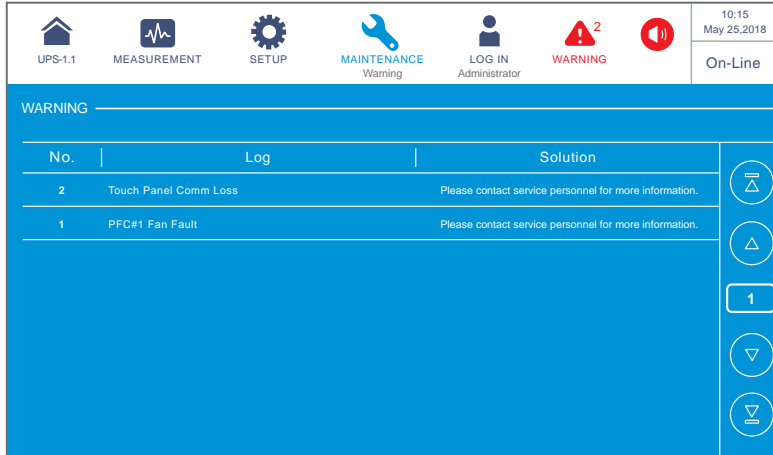

2. After connection of the EMS 1000 (EnviroProbe) to the UPS, if you don't set the status of the EMS 1000 (EnviroProbe) device (ID #) as 'Enable' (please refer to **7.10.10 EMS Setting**), the information of the EMS 1000 (EnviroProbe) device (ID #) will not show on the **EMS** screen.

If none of the status of the EMS 1000 (EnviroProbe) devices (ID #) is set as 'Enable' (please refer to **7.10.10 EMS Setting**), the **EMS** screen will show as follows.

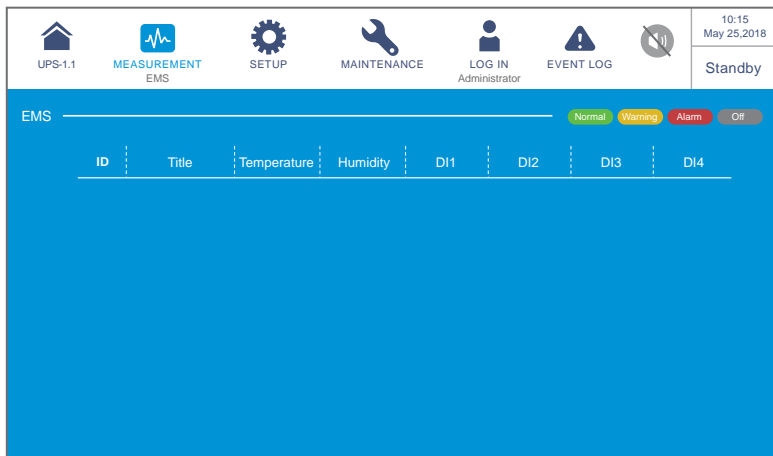

7.9.7.1 Connecting the optional EMS 1000 (EnviroProbe)

1. You can connect a maximum of 16 optional EMS 1000 (EnviroProbe) devices to each UPS to expand the environment monitoring range. A maximum of four UPS units can be paralleled. Please use the CAT-5 cable (user-supplied & the cable length depends on the on-site application and environment) to connect the EMS 1000 (EnviroProbe) to the EMS port on the UPS. For the location of the EMS port, please refer to **4.2 Communication Interfaces at the Rear of the Touch Panel**; for more information about installation of the optional EMS 1000 (EnviroProbe), please refer to **EnviroProbe 1000 Quick Guide**.
2. The UPS only supports RS485 communication mode. When installing the EMS 1000 (EnviroProbe), please set the device's communication mode as RS485 following **3-1 Comm DIP Switch Settings** of the **EnviroProbe 1000 Quick Guide**.
3. You have to assign a different ID # for each EMS 1000 (EnviroProbe) device connected to the UPS for the UPS to identify different devices. When installing the EMS 1000 (EnviroProbe), please set the ID # by the four ID DIP switches on the left of the device following **3-2 ID DIP Switch Settings** of the **EnviroProbe 1000 Quick Guide**.



NOTE:

1. You must set the ID # on the LCD according to the ID DIP switch setting on the EMS 1000 (EnviroProbe) device. Please refer to **7.10.10 EMS Setting**.
2. The ID # of each EMS 1000 (EnviroProbe) device connected to the UPS must be different.
3. When connecting more than one EMS 1000 (EnviroProbe) devices to the UPS, you don't have to set the ID # in numerical order.
4. To enable the EMS function of the UPS, you have to set up relevant items on the LCD after connecting the optional EMS 1000 (EnviroProbe) to the UPS. Please refer to **7.10.10 EMS Setting**.

7.10 UPS Settings

7.10.1 Bypass Setting

Path:  → Bypass Setting

After entering the **BYPASS SETTING** screen*¹ (shown in the figure below), you can set up the **Bypass Frequency Range**, **Bypass Voltage (Max.)**, **Bypass Voltage (Min.)** and **ECO Voltage Range**. If any value is out of range, the system will issue an alarm. These settings must be carried out by qualified service personnel. Please contact Delta customer service for assistance.



NOTE: *1 means that the **Administrator** password is needed. For password information, please refer to **7.5 Password Entry**.

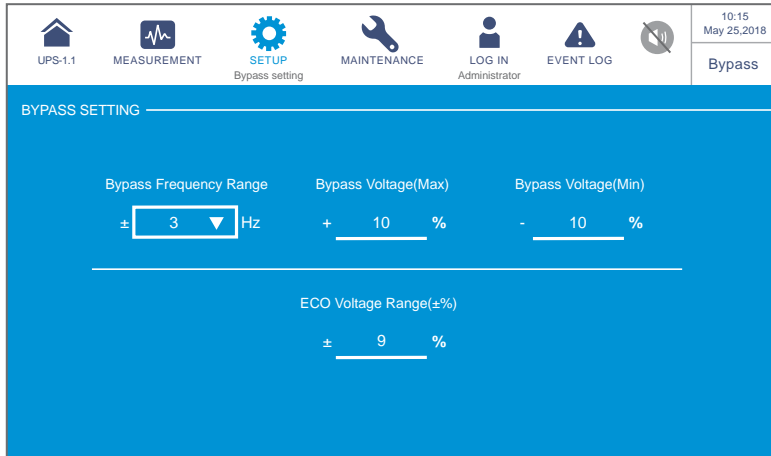

Item	Description
Bypass Frequency Range	Set up the bypass output's frequency range.
Bypass Voltage (Max.)	Set up the bypass output's maximum voltage.
Bypass Voltage (Min.)	Set up the bypass output's minimum voltage.
ECO Voltage Range	Set up the bypass output's voltage range in ECO mode.

7.10.2 Mode Setting



Path:  → **Mode Setting**

After entering the **MODE SETTING** screen*1 (shown in the figure below), you can set up the UPS system mode, of which there are 5 options: **On-Line Mode**, **Green Mode**, **ECO Mode**, **Energy Recycle Mode** and **Frequency Conversion Mode**. These settings must be carried out by qualified service personnel. Please contact Delta customer service for assistance.

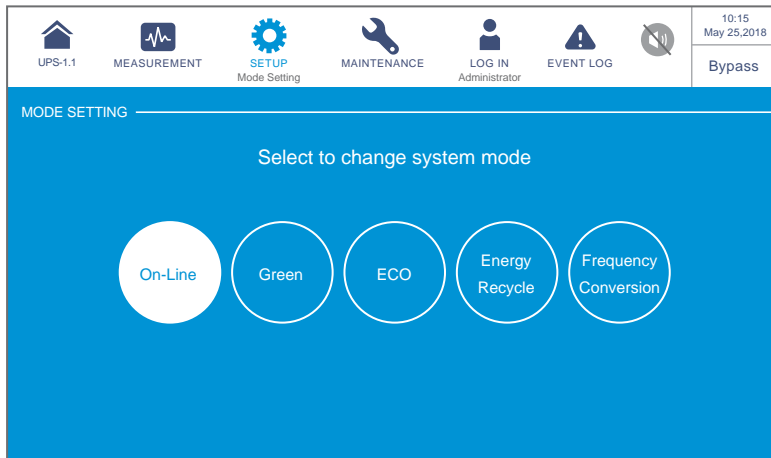

NOTE: *1 means that the **Administrator** password is needed. For password information, please refer to **7.5 Password Entry**.



Item	Description
On-Line Mode	Set up the UPS in On-Line mode. In On-Line mode, it is the inverter to supply power to the connected loads.
Green Mode	Set up the UPS in Green mode. In Green mode, it is the inverter to supply power to the connected loads and the power modules take turn to rest according to the situation of total load capacity.  NOTE: Green mode is only applicable to single UPS but not to parallel UPSs.
ECO Mode	Set up the UPS in ECO mode. In ECO mode, it is the bypass to supply power to the connected loads. It is suggested that you set the UPS in ECO mode only when there is stable main AC power. Otherwise, power supply quality will be compromised.
Energy Recycle Mode	Set up the UPS in Energy Recycle mode. In Energy Recycle mode, the full load output can be simulated for the aging test without real output to the loads.
Frequency Conversation Mode	Set up the UPS in Frequency Conversation mode. In Frequency Conversation mode, it is the inverter to supply power to the connected loads with a fixed output frequency. Please note that the output will be terminated once the inverter is turned off.  NOTE: Frequency Conversion mode is only applicable to single UPS but not to parallel UPSs.

7.10.3 Output Setting

Path:  → **Output Setting**

After entering the **OUTPUT SETTING** screen*¹ (shown in the figure below), you can set up the following items. These settings must be carried out by qualified service personnel. Please contact Delta customer service for assistance.



NOTE: *¹ means that the **Administrator** password is needed. For password information, please refer to **7.5 Password Entry**.

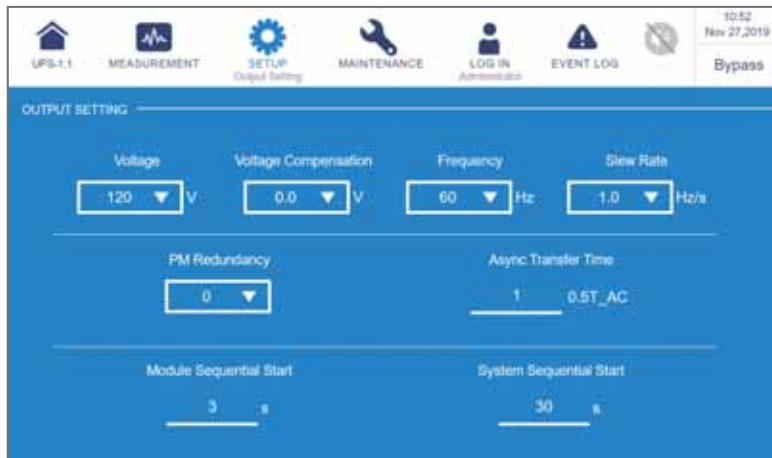

Item	Description
Voltage	Set up the output voltage.
Voltage Compensation	When the UPS is distant from the loads and there is a voltage drop in the output, you can adjust the INV output voltage amplitude for voltage compensation.
Frequency	Set up the output frequency as 50Hz (default) or 60Hz. The system will automatically select the output frequency in accordance with the bypass power.
Slew Rate	Set up the maximum permissible speed for the system output frequency to catch up the bypass frequency variation.
Power Module Redundancy	Set up how many power modules that need to be preserved for redundancy.

Item	Description
Asynchronous Transfer Time	When it is impossible for the inverter to reach synchronous phase lock with the bypass, the output will be terminated during conversion process according to this setup time.
Module Sequential Start	Set up the time interval for every power module to be converted from the battery mode to online mode. The setup is applicable to the generator to avoid bearing the whole loads right away.
System Sequential Start	Set up the time interval for the system to be converted from the battery mode to online mode. The setup is applicable to the generator to avoid bearing the whole loads right away.

7.10.4 Battery & Charging Setting

Path:  → **Battery & Charging Setting**

In the **BATTERY & CHARGING SETTING** screen*¹ (shown in the figure below), you can set up the following items. These settings must be carried out by qualified service personnel. Please contact Delta customer service for assistance.



NOTE: *¹ means that the **Administrator** password is needed. For password information, please refer to **7.5 Password Entry**.

UPS-1.1 MEASUREMENT SETUP Battery & Charging Setting MAINTENANCE LOG IN Administrator EVENT LOG 10:15 May 25, 2018 Bypass

BATTERY & CHARGING SETTING — PAGE 1 PAGE 2 PAGE 3 PAGE 4

Auto Equalized Charge: ▾

Auto Equalized Charge Interval: ▾

Equalized Charge Time: min

UPS-1.1 MEASUREMENT SETUP Battery & Charging Setting MAINTENANCE LOG IN Administrator EVENT LOG 10:15 May 25, 2018 Bypass

BATTERY & CHARGING SETTING — PAGE 1 PAGE 2 PAGE 3 PAGE 4

Battery Test Fail Voltage: V

Battery Test Duration: min

Auto Battery Test Interval: ▾

UPS-1.1 MEASUREMENT SETUP Battery & Charging Setting MAINTENANCE LOG IN Administrator EVENT LOG 10:15 May 25, 2018 Bypass



BATTERY & CHARGING SETTING — PAGE 1 PAGE 2 PAGE 3 PAGE 4

Low Temperature Alarm: ▾ °C

Installation Date: ▾

High Temperature Alarm: ▾ °C

Next Replacement Date: ▾

Item	Description
<p align="center">Battery Type</p>	<p>Set up the battery type as VRLA/ LiB (Dry Contact)*¹.</p> <p> NOTE: *¹ If you use non-Delta lithium-ion batteries, please set up the battery type as 'LiB (Dry Contact)'. For relevant settings, please refer to 4.1.6 Input Dry Contacts and 7.10.6 Dry Contact Setting. For more information about the configuration of lithium-ion batteries, please contact Delta customer service.</p>
Battery Rating Voltage	Set up the battery rating voltage.
Battery Strings	Set up how many battery strings that are used on site.
Battery Low Warning	Set up the battery low warning voltage.
Battery Cut Off Voltage	Set up the battery low voltage. In battery mode, when the battery low voltage is reached, the battery power will cut off, the UPS will shut down, and the connected loads won't be protected.
Capacity	Set up the battery capacity.
Float Charge Voltage	Set up the float charge voltage.
Equalized Charge Voltage	<p>Set up the equalized charge voltage.</p> <p> NOTE: The item will only show up if the Battery Type is set as 'VRLA'.</p>
Charge Current (Max)	Set up the maximum charge current.
Auto Equalized Charge	Enable or disable the auto-equalized charge.
Auto Equalized Charge Interval	Set up the auto equalized charge interval.
Equalized Charge Time	Set up the equalized charge time.
Battery Test Fail Voltage	Set up the battery test fail voltage. When the battery voltage is under the test fail voltage, it means battery fail.
Battery Test Duration	Set up how long the battery test should last.
Auto Battery Test Interval	Set up the battery test interval.
Low Temperature Alarm	Enable or disable the low temperature alarm. If enabled, set up the temperature.
High Temperature Alarm	Enable or disable the high temperature alarm. If enabled, set up the temperature.
Installation Date	Record the battery installation date.
Next Replacement Date	Set up the battery replacement date.

7.10.5 Parallel Setting

Path:  → **Parallel Setting**

After entering the **PARALLEL SETTING** screen*¹ (shown in the figure below), you can set up the following items. These settings must be carried out by qualified service personnel. Please contact Delta customer service for assistance.



NOTE: *¹ means that the **Administrator** password is needed. For password information, please refer to **7.5 Password Entry**.

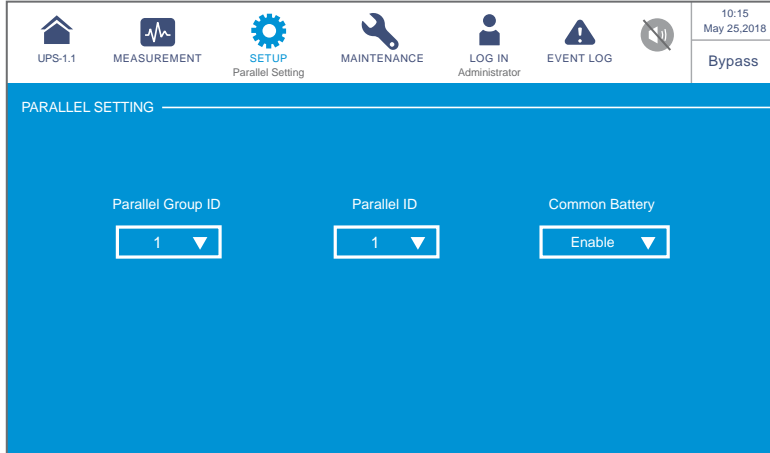

Item	Description
Parallel Group ID	The UPSs in parallel connection must be assigned the same parallel group ID No. in order to let the outputs of the parallel UPSs be put in parallel connection and let the loads be evenly distributed among the parallel units. If the parallel UPSs have different parallel group ID No., their output signals might be synchronized but their outputs cannot be connected in parallel.
Parallel ID	The UPSs that need to be paralleled must be assigned the same parallel group ID No. and different parallel ID No. in order to let the parallel function work.
Common Battery	If the parallel UPSs that have the same parallel group ID No. need to share common batteries, please select 'Enable' for the 'Common Battery' setup item. Otherwise, the function of battery abnormality detection will fail. For more information about common battery, please refer to 3.4 Common Battery (Only for Parallel UPSs connecting to the Same External Battery Cabinet(s)) .

7.10.6 Dry Contact Setting

Path:  → Dry Contact Setting

In the **DRY CONTACT SETTING** screen*¹ (shown in the figure below), the event, NO (normally open) or NC (normally closed) for each of the input and output dry contacts can be set up. These settings must be carried out by qualified service personnel. Please contact Delta customer service for assistance.



NOTE: *¹ means that the **Administrator** password is needed. For password information, please refer to **7.5 Password Entry**.

Input Dry Contact No.	Event Selection	Type
Input Dry Contact 1 Input Dry Contact 2 Input Dry Contact 3 Input Dry Contact 4	Select one of the following events as the setting for each input dry contact. <ol style="list-style-type: none"> 1. None 2. Generator status 3. Battery ground fail 4. External battery breaker detection 5. Charge Off (Positive) 6. Charge Off (Negative) 7. Battery Abnormal Shutdown 8. Input Transformer OTW 9. Output Transformer OTW 10. Battery Fuse Open 	Set up NO (normally open) or NC (normally closed) for each input dry contact.

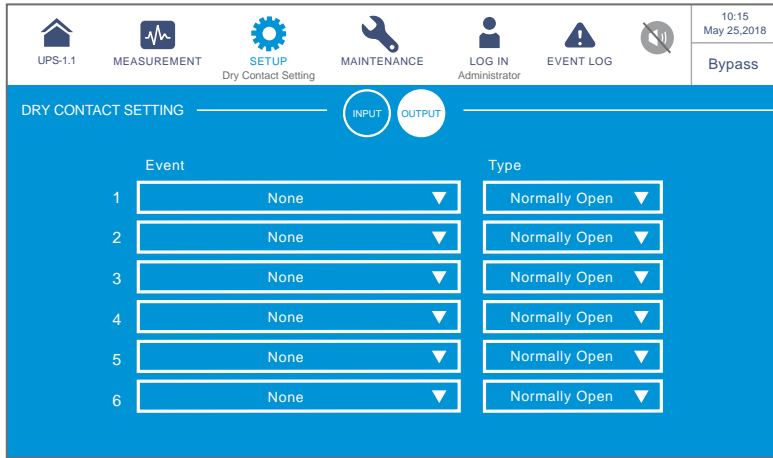

Output Dry Contact No.	Event Selection	Type
<p>Output Dry Contact 1 Output Dry Contact 2 Output Dry Contact 3 Output Dry Contact 4 Output Dry Contact 5 Output Dry Contact 6</p>	<p>Select one of the following events as the setting for each output dry contact.</p> <ol style="list-style-type: none"> 1. None 2. Load on inverter 3. Load on bypass 4. Load on battery 5. Battery low 6. Battery input abnormal 7. Battery test fail 8. Internal comm. fail 9. External parallel comm. fail (only applicable to parallel application) 10. Output overload 11. EPO activated 12. Load on manual bypass 13. Battery over temperature 14. Output voltage abnormal 15. Battery need replacement 16. Bypass over temperature 17. Bypass static switch fault 18. UPS over temperature 19. Battery breaker shunt trip 20. Backfeed protection 21. UPS general alarm 	<p>Set up NO (normally open) or NC (normally closed) for each output dry contact.</p>



7.10.7 General Setting

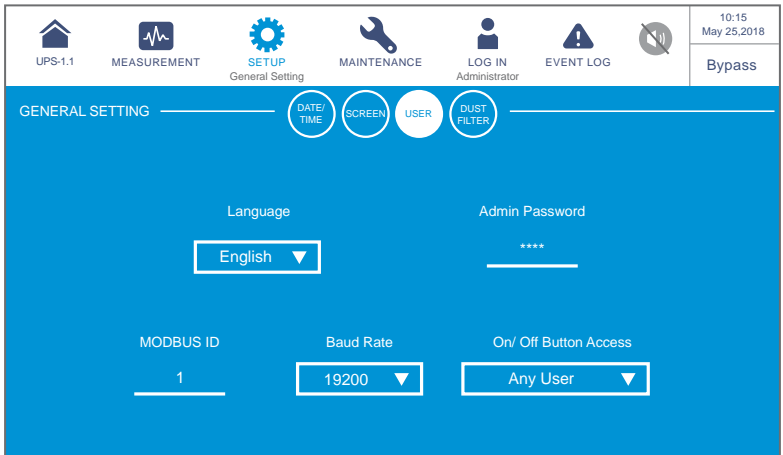
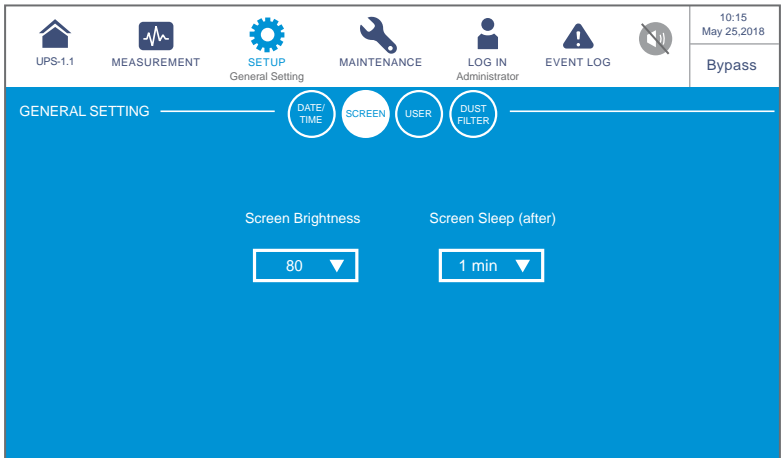
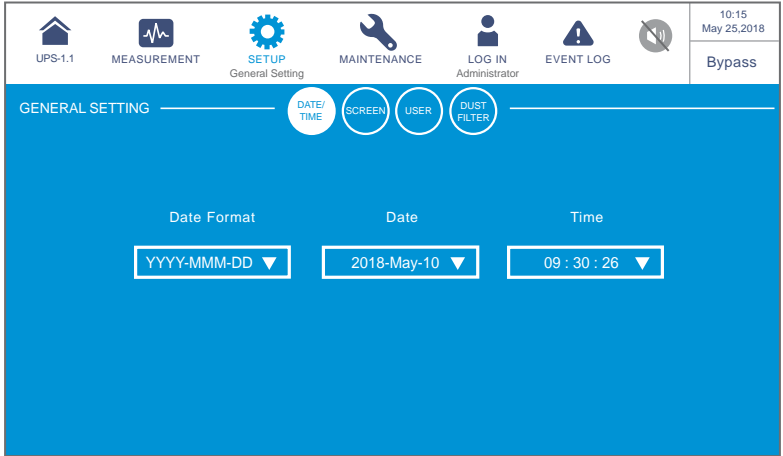

Path:  → General Setting

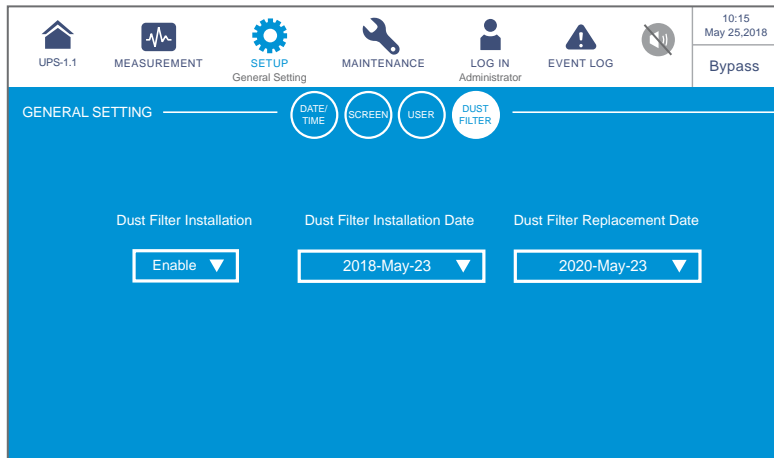
After entering the **GENERAL SETTING** screen (shown in the figure below), you can set up the following items.





Item	Sub Item	Description
DATE/ TIME	Date Format	Select the date format.
	Date	Set up the date.
	Time	Set up the time.
SCREEN	Screen Brightness	Adjust the LCD display brightness (default: 80).
	Screen Sleep (after)	Set up the LCD backlight sleep time (default: 1 minute).
USER	Language	Set up the display language (default: English).
	Admin Password* ¹	Set up the administrator password (4 digits).
	MODBUS ID* ¹	Set up the MODBUS ID for the MODBUS port located at the rear of the touch panel. For the location of the MODBUS port, see Figure 4-17 .
	Baud Rate* ¹	Set up the baud rate for the MODBUS port located at the rear of the touch panel. For the location of the MODBUS port, see Figure 4-17 .
	On/ Off Button Access* ¹	Set up the access for the ON/ OFF Button () as 'Any User' or 'Administrator Only' .
DUST FILTER*¹	Dust Filter Installation	If you have installed any dust filter, please select 'Enable' ; if not, please select 'Disable' .
	Dust Filter Installation Date	Set up the dust filter installation date.  NOTE: Only when you select 'Enable' for 'Dust Filter Installation' can you set up the 'Dust Filter Installation Date' .

Item	Sub Item	Description
DUST FILTER* ¹	Dust Filter Installation	If you have installed any dust filter, please select ' Enable '; if not, please select ' Disable '.
	Dust Filter Installation Date	Set up the dust filter installation date.  NOTE: Only when you select ' Enable ' for ' Dust Filter Installation ' can you set up the ' Dust Filter Installation Date '.
	Dust Filter Replacement Date	Set up the dust filter replacement date. When the date is due, the red warning icon () will automatically appear in the upper right corner of the LCD, and the alarm message ' Replace Dust Filter ' will be displayed.  NOTE: Only when you select ' Enable ' for ' Dust Filter Installation ' can you set up the ' Dust Filter Installation Date '.



NOTE:

*¹ means that the **Administrator** password is needed. For password information, please refer to **7.5 Password Entry**.

7.10.8 IP Setting

Path:  → IP Setting

After entering the **IP SETTING** screen*¹ (shown in the figure below), you can set up the following items. These settings must be carried out by qualified service personnel. Please contact Delta customer service for assistance.



NOTE: *¹ means that the **Administrator** password is needed. For password information, please refer to **7.5 Password Entry**.

UPS-1.1	MEASUREMENT	SETUP IP Setting	MAINTENANCE	LOG IN Administrator	EVENT LOG	10:15 May 25, 2018
						Bypass
IP SETTING						
DHCP Client		IP Address	Subnet Mask	Gateway IP		
Enable ▼		172.16.190.64	255.255.254.0	172.16.191.254		
DNS 1 IP		DNS 2 IP	Search Domain	Host Name		
172.16.176.200		172.16.0.1	delta.corp	DELTA		

Item	Description
DHCP Client	Enable or disable the DHCP client.
IP Address	Set up the IP address.
Subnet Mask	Set up the subnet mask.
Gateway IP	Set up the gateway IP address.
DNS 1 IP	Set up the DNS server 1 IP address.
DNS 2 IP	Set up the DNS server 2 IP address.
Search Domain	Set up the search domain.
Host Name	Set up the host name.

7.10.9 Control

Path:  → **Control**

After entering the **CONTROL** screen (shown in the figure below), you can set up the following items. These settings must be carried out by qualified service personnel. Please contact Delta customer service for assistance.

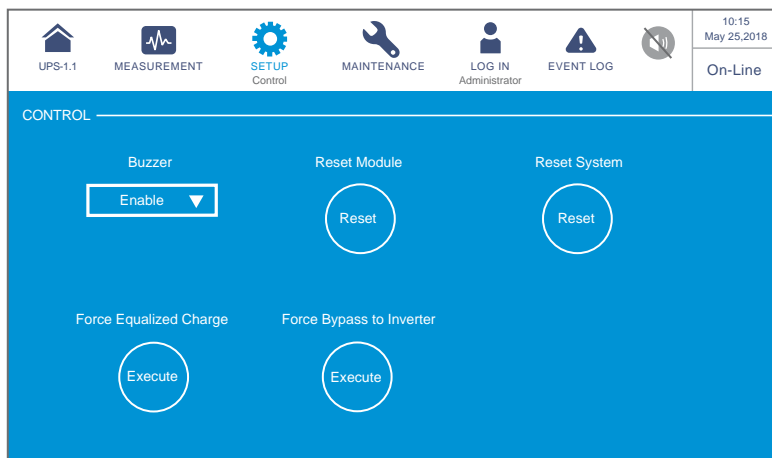

Item	Description
Buzzer	Enable or disable the buzzer.
Reset Module* ¹	Reset the power modules or not. In bypass mode, when you tap the ON/ OFF Button (⏻) to start up the UPS but the UPS does not respond, please select 'Reset' to reset the power modules. After the power modules are reset, please tap the ON/ OFF Button (⏻) to start up the UPS.

Item	Description
Reset System*¹	Reset the system or not. In bypass mode, when you tap the ON/ OFF Button (⏻) to start up the UPS but the UPS does not respond, please select ' Reset ' to reset the system. After the system is reset, please tap the ON/ OFF Button (⏻) to start up the UPS.
Force Equalized Charge*¹	Manually force the UPS to run in auto equalized charge mode to charge the batteries.
Force Bypass to Inverter*¹	Manually force the UPS to switch from bypass to inverter when the inverter keeps staying in the soft-start status and is unable to transfer to on-line mode successfully.



NOTE: *¹ means that the **Administrator** password is needed. For password information, please refer to **7.5 Password Entry**.

7.10.10 EMS Setting

Path:  → **EMS Setting**

After entering the **EMS SETTING** screen*¹ (shown in the figure below), you can set up the following items. These settings must be carried out by qualified service personnel. Please contact Delta customer service for assistance.



NOTE: *¹ means that the **Administrator** password is needed. For password information, please refer to **7.5 Password Entry**.

Temperature		Humidity	
Alarm	> 40.0 °C	Alarm	> 90 %
Recovery	< 38.0 °C	Recovery	< 85 %
Warning	> 30.0 °C	Warning	> 80 %
Recovery	< 28.0 °C	Recovery	< 75 %

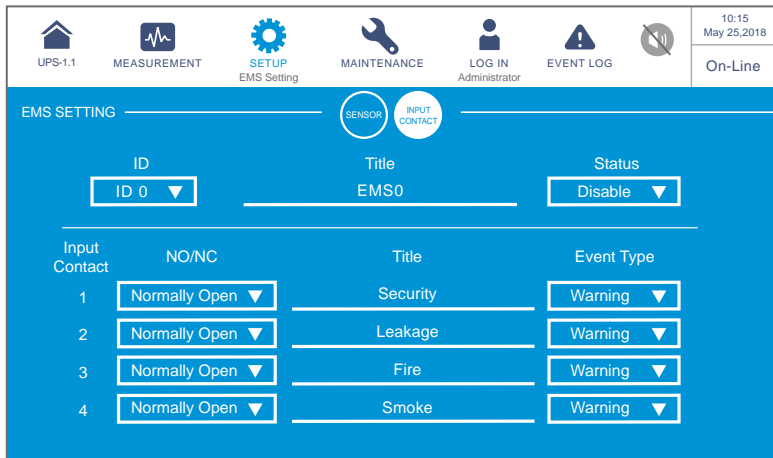

NOTE:

After connecting the optional EMS 1000 (EnviroProbe) to the UPS, you have to manually set both **ID** and **Status** to enable the EMS function of the UPS. Settings for the other items can be adjusted according to your needs; the default values are shown in the figures above.

Item	Sub Item	Description
SENSOR	ID	Set the ID # (ID 0/ ID 1/ .../ ID 15) according to the ID DIP switch set on the EMS 1000 (EnviroProbe) device. For the ID DIP switch settings, please refer to 7.9.7.1 Connecting the optional EMS 1000 (EnviroProbe) .  NOTE: If the ID # setting is wrong, the warning message ' The EMS 1000 ID # Communication Fail ' will appear.
	Title	Set the title for the EMS 1000 (EnviroProbe), 16 characters at most.
	Status	The status Enable/ Disable determines whether or not the LCD shows the EMS information of the EMS 1000 (EnviroProbe) device (ID #).
	Temperature	Set the temperature (°C) values for Alarm/ Warning/ Recovery.
	Humidity	Set the Humidity (%) values for Alarm/ Warning/ Recovery.

Item	Sub Item	Description
INPUT CONTACT	Input Contact 1	1. Set the input contact as Normally Open (NO)/ Normally Closed (NC). 2. Set the title for the input contact, 16 characters at most. 3. Set the Event Type as None/ Information/ Warning/ Alarm.
	Input Contact 2	
	Input Contact 3	
	Input Contact 4	

Not only does the **EMS** screen show status of the input contacts (please refer to **7.9.7 EMS**), but the **Warning** screen, **Historical Event** screen, UPS tri-color LED indicator and buzzer also response to the status of the input contacts.



NOTE: For the location of the UPS tri-color LED indicator and buzzer, please refer to **2.8 Tri-color LED Indicator & Buzzer**.



Event Type of Input Contact	EMS DI1~DI4 (LCD)	Tri-color LED Indicator	Buzzer	Warning (LCD)	Historical Event (LCD)
None	Green	Green	No Sound	No	No
Information	Green	Green	No Sound	No	Yes
Warning	Yellow	Yellow	Short Beep	Yes	Yes
Alarm	Red	Red	Long Beep	Yes	Yes





All the above settings are related to the items shown on the **EMS** screen in the  → **EMS**. Please refer to **7.9.7 EMS**.

7.11 System Maintenance

7.11.1 Alarm Warning

Path 1:  → **Warning**

Path 2: When there is a warning, the buzzer icon () will light up in red, and the buzzer will make an alarm sound. Tap the warning icon () to enter the **WARNING** screen.

After entering the **WARNING** screen (shown in the figure below), you can use the (   ) icons to view the warning logs or use the function key () to enter a specific page No. to check the warning logs. The system can store at maximum 200 warning logs.



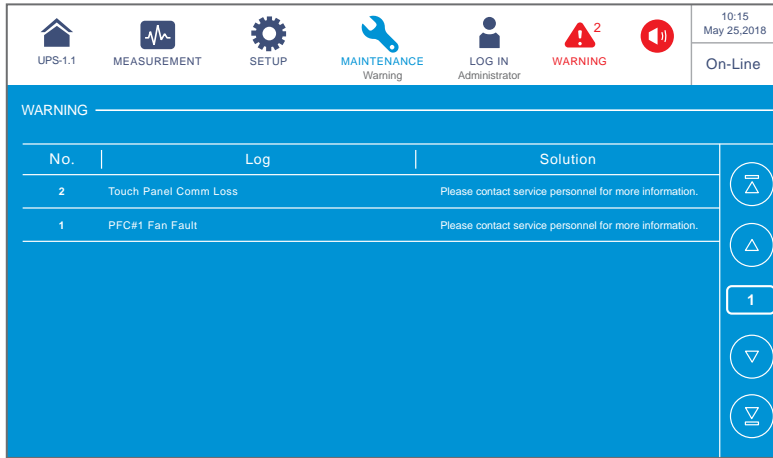

The **WARNING** screen also displays relevant solutions. For warning solutions, please refer to **10. Troubleshooting**.



7.11.2 Historical Event

Path:  MAINTENANCE → **Historical Event**

The **HISTORICAL EVENT** screen shown below provides each historical event's No., start date and time, code (red: serious; orange: minor; green: normal), location, and log description. You can tap the icon () to magnify the entire historical event description.

You can use the icons (   ) to check the historical event logs or use the function key () to enter a specific page No. to view the historical event logs.

The system can save up to 10000 historical event logs. The greater the event number is, the newer the event is. When the total number of historical event logs exceeds the storage capacity (up to 10000 entries), the oldest 500 historical event logs will be overwritten.

You can tap the download icon ()^{*1} to download the historical event logs. To clear the historical event logs, please refer to **7.11.5 Clear**.

 **NOTE:** ^{*1} means that the **Administrator** password is needed. For password information, please refer to **7.5 Password Entry**.

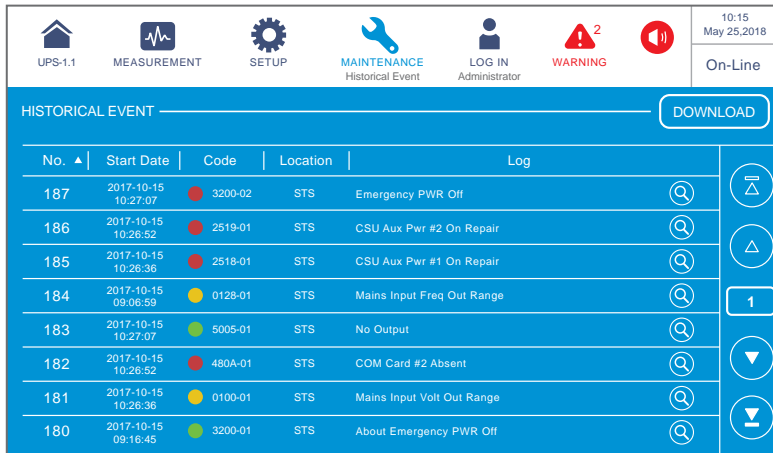

No.	Start Date	Code	Location	Log	
179	2017-10-15 09:06:59	480A-01	STS	Battery Disconnected	🔍
178	2017-10-15 08:22:45	1021-01	STS	Mains Input Freq Out Range	🔍
177	2017-10-15 08:10:06	2501-01	STS	Mains Input Volt Out Range	🔍
176	2017-10-15 07:58:15	501F-01	STS	UPS Soft Start	🔍
175	2017-10-15 07:48:22	500S-01	STS	No Output	🔍
174	2017-10-15 07:35:10	480A-01	STS	COM Card #2 Absent	🔍
173	2017-10-15 07:25:25	0100-01	STS	Mains Input Volt Out Range	🔍
172	2017-10-15 07:15:02	3200-01	STS	About Emergency PWR Off	🔍

7.11.3 Statistics

Path:  → **Statistics**

After entering the **STATISTICS** screen (shown in the figure below), you can view the following statistics.

Item	Description
In Battery Mode	3 times
Battery Mode Duration	1 hours
In Bypass Mode	3 times
Bypass Mode Duration	1 hours
Operation Time	147 hours

Item	Description
In Battery Mode	Means how many times that the UPS runs in battery mode.
Battery Mode Duration	Means how long the UPS runs in battery mode.
In Bypass Mode	Means how many times that the UPS runs in bypass mode.
Bypass Mode Duration	Means how long the UPS runs in bypass mode.
Operation Time	Means how long the UPS has operated.

To clear the statistics, please refer to **7.11.5 Clear**.

7.11.4 Test

Path:  MAINTENANCE → **Test**

After entering the **TEST** screen*¹ (shown in the figure below), you can perform a manual battery test.



NOTE: *¹ means that the **Administrator** password is needed. For password information, please refer to **7.5 Password Entry**.

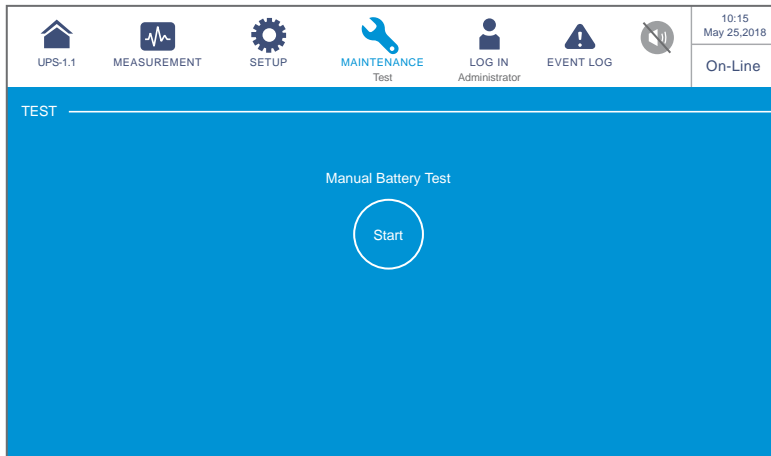

7.11.5 Clear

Path:  MAINTENANCE → **Clear**

After entering the **CLEAR** screen*¹ (shown in the figure below), you can clear the records of (1) statistics, (2) historical event, (3) battery test result and (4) kilowatt hour (kWh).



NOTE: *¹ means that the **Administrator** password is needed. For password information, please refer to **7.5 Password Entry**.

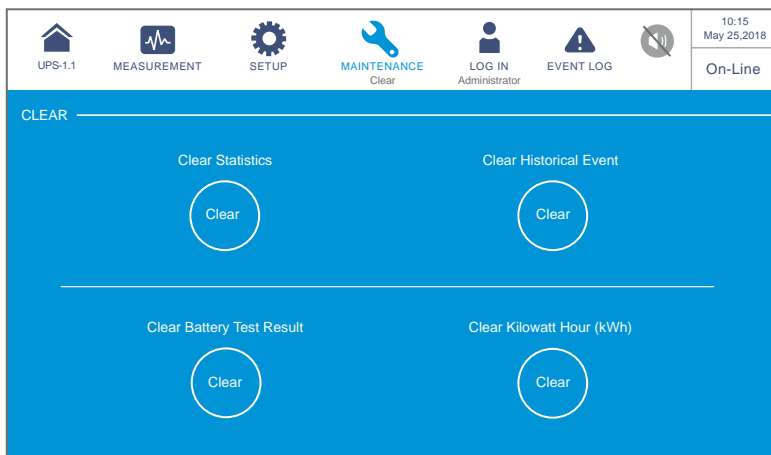

Item	Description
Clear Statistics	After you select ' Clear ' and confirm clearance of statistics, all records of the statistics will be cleared.
Clear Historical Event	After you select ' Clear ' and confirm clearance of historical event logs, all historical event logs will be cleared.
Clear Battery Test Result	After you select ' Clear ' and confirm clearance of battery test result, the battery test result will be cleared.
Clear Kilowatt Hour (kWh)	After you select ' Clear ' and confirm clearance of kilowatt hour records, the kilowatt hour statistics will be cleared.



NOTE:

The records of (1) statistics, (2) historical event, (3) battery test result, and (4) kilowatt hour (kWh) provide important information for system analysis and maintenance. Do not clear any of them without the consent of qualified service personnel.

7.11.6 Advanced Diagnosis









Path:  MAINTENANCE → **Advanced Diagnosis**

After entering the **ADVANCED DIAGNOSIS** screen*¹ (shown in the figure below), you can check:

1. STS temperature, battery temperature, and fan speed of the system.
2. INV temperature and PFC temperature of a specific battery module.



NOTE: *¹ means that the **Administrator** password is needed. For password information, please refer to **7.5 Password Entry**.

 UPS-1.1  MEASUREMENT  SETUP  MAINTENANCE Advanced Diagnosis  LOG IN Administrator  EVENT LOG 						10:15 May 25, 2018
ADVANCED DIAGNOSIS						Bypass
		 SYSTEM  POWER MODULE				
STS Temp. (°C)		25	25	25		
Battery Temp. (°C)	25	25	25	25		
Fan Speed (rpm)		2300	2300	-		



7.11.7 Version & S/N



NOTE:

1. To operate the UPS in parallel, please make sure the version and serial No. of each following item is the same for each parallel unit.
2. The **Administrator** password is needed for the icon (). For password information, please refer to **7.5 Password Entry**.

Path:  → **Version & S/N**

After entering the **VERSION & S/N** screen (shown in the figure below), you can check and update every version and serial number. For detailed information please refer to the table below.

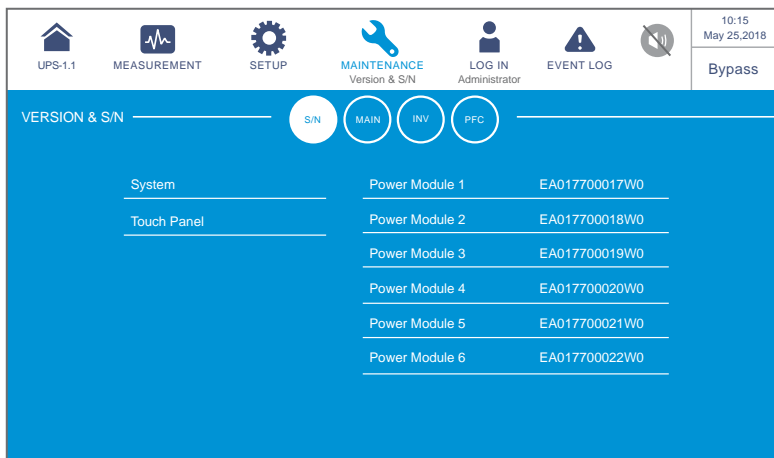

UPS-1.1 MEASUREMENT SETUP MAINTENANCE Version & S/N LOG IN Administrator EVENT LOG 10:15 May 25,2018 Bypass

VERSION & S/N S/N MAIN INV PFC

	MCU	FPGA
Parallel Communication Card #1	0H0017AR00.03.03	4A0000AR00.01.02
Parallel Communication Card #2	0H0017AR00.03.03	4A0000AR00.01.02
System Control Card	0H0017AR00.05.02	4A0000AR00.00.00
Touch Panel	00.130	

Choose File

UPGRADE

UPS-1.1 MEASUREMENT SETUP MAINTENANCE Version & S/N LOG IN Administrator EVENT LOG 10:15 May 25,2018 Bypass

VERSION & S/N S/N MAIN INV PFC

	MCU	FPGA	MCU	FPGA	
PM 01	0H0014AR00.07.00	4A001AR00.00.00	PM 02	0H0014AR00.07.00	4A001AR00.00.00
PM 03	0H0014AR00.07.00	4A001AR00.00.00	PM 04	0H0014AR00.07.00	4A001AR00.00.00
PM 05	0H0014AR00.07.00	4A001AR00.00.00	PM 06	0H0014AR00.07.00	4A001AR00.00.00

Choose File

UPGRADE

UPS-1.1 MEASUREMENT SETUP MAINTENANCE Version & S/N LOG IN Administrator EVENT LOG 10:15 May 25,2018 Bypass

VERSION & S/N S/N MAIN INV PFC

	MCU	FPGA	MCU	FPGA	
PM 01	0H0014AR00.07.00	4A001AR00.00.00	PM 02	0H0014AR00.07.00	4A001AR00.00.00
PM 03	0H0014AR00.07.00	4A001AR00.00.00	PM 04	0H0014AR00.07.00	4A001AR00.00.00
PM 05	0H0014AR00.07.00	4A001AR00.00.00	PM 06	0H0014AR00.07.00	4A001AR00.00.00

Choose File

UPGRADE

Item	Sub Item	Description
S/N	System	Check the system's serial No.
	Touch Panel	Check the touch panel's serial No.
	Power Module #	Check a specific power module's serial No.
MAIN	Parallel Communication Card #_ MCU/ FPGA	Check and update the MCU or FPGA firmware version of a specific parallel communication card.
	System Control Card_ MCU/ FPGA	Check and update the MCU or FPGA firmware version of the system control card.
	Touch Panel _ MCU	Check and update the touch panel's MCU firmware version.
INV	PM #_ MCU/ FPGA	Check and update the MCU or FPGA firmware version of a specific power module's inverter.
PFC	PM #_ MCU/ FPGA	Check and update the MCU or FPGA firmware version of a specific power module's PFC.

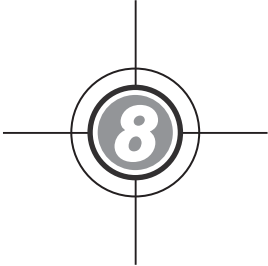

Optional Accessories

There are several optional accessories available for this DPH series UPS. Please refer to the table below for the optional accessories and their descriptions.

No.	Item	Function
1	Dust Filter	Prevents dust from entering into the UPS to ensure UPS reliability and to prolong product life.
2	Relay I/O Card	Increases the quantity of dry contacts.
3	EMS 1000 (EnviroProbe)	Monitors temperature, humidity and other connected monitoring devices in a room environment. Connect the EMS 1000 (EnviroProbe) to the UPS's EMS port located at the rear of the touch panel, and the UPS will integrate the detected information of the EMS 1000 (EnviroProbe) and display relevant data on the LCD. See Figure 4-17 for the location of the EMS port. For more information about the application of the EMS 1000 (EnviroProbe), please refer to 7.9.7 EMS .
4	Battery Cabinet Temperature Sensor Cable	Detects the temperature of an external battery cabinet connected to the UPS.
5	Parallel Cable (5-meter long)	Connects the parallel UPSs.
6	Parallel Cable (10-meter long)	Connects the parallel UPSs.
7	Battery Management System (BMS)	<p>If you use the lead-acid batteries, it is recommended to install the BMS to monitor (1) each battery's voltage, (2) each battery string's voltage and charging/ discharging current, and (3) battery environment temperature.</p> <p>The BMS should be connected to the UPS's BMS port located at the rear of the touch panel (see Figure 4-17). For relevant readings and settings, please refer to 7.9.6 Battery Status and 7.10.4 Battery Charging Setting.</p> <p> NOTE: The number of the BMS that needs to be installed in the UPS depends on how many external battery cabinets are connected with the UPS. For the installation of the BMS, please contact Delta customer service.</p>
8	External Battery Cabinet	Provides the space for the optional battery modules to be installed as a complete solution to let the UPS continue supplying power to its connected loads when a power outage occurs.

No.	Item	Function
9	Battery Module (with batteries)	To be installed in the optional external battery cabinet.
10	Battery Module (without batteries)	<ol style="list-style-type: none"> 1. Provides the space for batteries to be installed. For how many batteries and what types of batteries that should be installed inside the empty battery module, please contact Delta service personnel for more information. 2. To be installed in the optional external battery cabinet.

**NOTE:**

1. For details of installation and operation of the accessories mentioned above, please refer to the **Quick Guide**, **User Guide**, or **Installation & Operation Guide** included in the package of the relevant optional accessory.
2. If you want to purchase any accessories mentioned above, please contact your local dealer or customer service.



Maintenance

- **UPS**

1. UPS Cleaning:

Regularly clean the UPS, especially the slits, openings and filters, to ensure that the air freely flows into the UPS to avoid overheating. If necessary, use an air-gun to clean the slits and openings and replace the filters regularly to prevent any object from blocking or covering these areas.

2. UPS Regular Inspection:

- a. Monthly check the filters and regularly replace them.
- b. Regularly check the UPS every half year and inspect:
 - 1) Whether the UPS, LED indicators, and alarm function are operating normally.
 - 2) Whether the UPS works in bypass mode (normally, the UPS works in normal mode). If yes, check if any error, overload, internal fault, etc. occurs.
 - 3) Whether battery voltage is normal. If the battery voltage is too high or too low, find the root cause.

- **Batteries**

The DPH series UPS uses the lead-acid batteries or the lithium-ion batteries. The battery life depends on the temperature, the usage, and the charging/ discharging frequency. High temperature environments and high charging/ discharging frequency will quickly shorten the battery life. Please follow the suggestions below to ensure a normal battery lifetime.

1. Keep the nominal operating temperature between 22°C ~ 28°C (71.6°F ~ 82.4°F). .
2. When the UPS needs to be stored for an extended period of time, the lead-acid batteries must be recharged once every three months and the charging time must not be less than 24 hours each time. As for the lithium-ion batteries, please contact your battery supplier for the charging frequency and charging duration.

- **Fans**

Higher temperatures shorten fan life. When the UPS is running, please check if all of the fans work normally and make sure if the ventilation air can move freely around and through the UPS. If not, replace the fans.



NOTE:

Please ask your local dealer or customer service for more maintenance information. Do not perform maintenance if you are not trained for it.



Troubleshooting

When you see the following alarm messages appear on the LCD, please follow the solutions shown below. If you see other alarm messages that are not listed in the table below, please contact Delta service personnel for assistance. Do not perform troubleshooting if you are not trained for it.

No.	Alarm Message	Possible Cause	Solution
1	Mains Input Volt/ Freq Out Range	<ol style="list-style-type: none"> 1. The input breaker is turned off. 2. The main AC source's voltage or frequency is abnormal. 	<ol style="list-style-type: none"> 1. Please check if the input breaker is turned off or not. If yes, please turn it on. 2. Please check if the main AC source's voltage or frequency is abnormal or not. If yes, please wait for the main AC source to be restored. 3. If the alarm message still exists after the solutions mentioned above have been executed, please contact service personnel.
2	Mains Input Volt Phase Seq Abnormal	The wiring is incorrect.	Please check the wiring and phase sequence of the main AC source, and contact service personnel for assistance.
3	Mains Input Breaker Off	The input breaker is turned off.	<ol style="list-style-type: none"> 1. Please check if the input breaker is turned off or not. If yes, please turn it on. 2. If the alarm message still exists after the solution mentioned above has been executed, please contact service personnel.
4	Bypass Input Volt Out Range	<ol style="list-style-type: none"> 1. The bypass breaker is turned off. 2. The bypass AC source's voltage is abnormal. 	<ol style="list-style-type: none"> 1. Please check if the bypass breaker is turned off or not. If yes, please turn it on. 2. Please check if the bypass AC source's voltage is abnormal or not. If yes, please wait for the bypass AC source to be restored. 3. If the alarm message still exists after the solutions mentioned above have been executed, please contact service personnel.

No.	Alarm Message	Possible Cause	Solution
5	Bypass Input Freq Out Range	<ol style="list-style-type: none"> 1. The bypass breaker is turned off. 2. The bypass AC source's frequency is abnormal. 	<ol style="list-style-type: none"> 1. Please check if the bypass breaker is turned off or not. If yes, please turn it on. 2. Please check if the bypass AC source's frequency is abnormal or not. If yes, please wait for the bypass AC source to be restored. 3. If the alarm message still exists after the solutions mentioned above have been executed, please contact service personnel.
6	Bypass Input Volt Phase Seq Abnormal	The wiring is incorrect.	Please check the wiring and phase sequence of the bypass AC source, and contact service personnel for assistance.
7	Bypass Volt Out ECO Range	The bypass AC source's voltage or frequency exceeds the range for ECO mode.	Please check the bypass AC source's voltage and frequency. If there is any abnormality, please wait for the bypass AC source to be restored.
8	Bypass Breaker Off	For single input application, the input breaker is turned off.	<ol style="list-style-type: none"> 1. Please check if the input breaker is turned off or not. If yes, please turn it on. 2. If the alarm message still exists after the solution mentioned above has been executed, please contact service personnel.
		For dual input application, the bypass breaker is turned off.	<ol style="list-style-type: none"> 1. Please check if the bypass breaker is turned off or not. If yes, please turn it on. 2. If the alarm message still exists after the solution mentioned above has been executed, please contact service personnel.
9	Bypass STS Critical Over Heat	Heat dissipation is poor or components are damaged.	<ol style="list-style-type: none"> 1. Check if any foreign matter blocks the fans or air inlets. If yes, remove the foreign matter. 2. Decrease some loads. 3. If the alarm message still exists after the solutions mentioned above have been executed, please contact service personnel.

No.	Alarm Message	Possible Cause	Solution
10	Bypass STS Open Fault	The bypass static switch or its drive circuit is abnormal.	Please contact service personnel for assistance.
11	Battery End of Discharge Imminent	The battery voltage is lower than the alarm value.	If there is no bypass power feeding to the system, please shut down the connected loads in accordance with normal procedures as soon as possible.
12	Battery End Of Discharge	The battery voltage is lower than the setup value of Battery Cut Off Voltage.	If there is no bypass power feeding to the system, please shut down the connected loads in accordance with normal procedures as soon as possible.
13	Battery Over Charged	The charger is abnormal.	Please contact service personnel for assistance.
14	Battery Disconnected	<ol style="list-style-type: none"> 1. The batteries are not connected. 2. The external battery cabinet's breaker is turned off. 	<ol style="list-style-type: none"> 1. Please check if the batteries are properly connected. 2. Please check if the external battery cabinet's breaker is turned off or not. If yes, please turn it on. 3. If the alarm message still exists after the solutions mentioned above have been executed, please contact service personnel.
15	Battery Life Expired	<ol style="list-style-type: none"> 1. The battery replacement date is due. 2. The system date is wrongly set. 	<ol style="list-style-type: none"> 1. Please check if the battery replacement date is due or not. If yes, please contact service personnel for assistance. 2. Please check the setting of the system date. If there is any error, please correct it.
16	Battery Reversed	The battery wiring is wrong.	Check the battery wiring. If there is any error or abnormality, please contact service personnel for assistance.
17	Battery Test Fail	The battery wiring is wrong or battery abnormalities exist.	Check the batteries. If wrong battery wiring or battery abnormalities exist, please contact service personnel for assistance.

No.	Alarm Message	Possible Cause	Solution
18	Battery Ground Fault	The battery grounding is wrong or the input dry contact configuration is wrong.	<ol style="list-style-type: none"> 1. Check if the battery wiring is normal or not. 2. Check if the input dry contact configuration is normal or not. 3. If the alarm message still exists after the solutions mentioned above have been executed, please contact service personnel.
19	Battery Breaker OFF	The external battery cabinet's breaker is turned off.	<ol style="list-style-type: none"> 1. Please check if the external battery cabinet's breaker is turned off or not. If yes, please turn it on. 2. Check if the settings of input dry contacts are correct. 3. If the alarm message still exists after the solution mentioned above has been executed, please contact service personnel.
20	Battery Over Temperature	The battery temperature is too high or the batteries are abnormal.	<ol style="list-style-type: none"> 1. Improve ventilation to reduce the battery temperature. 2. Check if the batteries are abnormal or not. If yes, please contact service personnel for assistance.
21	Battery Under Temperature	The battery temperature is too low or the batteries are abnormal.	<ol style="list-style-type: none"> 1. Check the battery constant temperature equipment. 2. Check if the batteries are abnormal or not. If yes, please contact service personnel for assistance.
22	Output Overload Warning	The connected loads exceed the rated value.	Please decrease the loads.
23	Output Overload Shutdown	The connected loads exceed the rated value for a long time.	<ol style="list-style-type: none"> 1. After overload shutdown, the connected loads will be supplied via the bypass. Please decrease the loads to let the system re-start automatically. 2. If the alarm message still exists after the solution mentioned above has been executed, please contact service personnel.
24	Inverter Voltage Abnormal	The system's inverter total output voltage is abnormal.	Please contact service personnel for assistance.

No.	Alarm Message	Possible Cause	Solution
25	INV #n Over Current Warning	The inverter output current of the power module #n is too high.	Please contact service personnel for assistance.
26	INV #n Over Current Shutdown	The inverter output current of the power module #n is too high.	Please contact service personnel for assistance.
27	INV #n Load Sharing Unbalance	The connected loads are abnormal or the inverter of the power module #n is damaged.	Please contact service personnel for assistance.
28	Output Breaker Off	The output breaker is off.	<ol style="list-style-type: none"> 1. Please check if the output breaker is turned off or not. If yes, please turn it on. 2. If the alarm message still exists after the solution mentioned above has been executed, please contact service personnel.
29	PM Redundancy Loss	The connected loads exceed the redundancy setting.	<ol style="list-style-type: none"> 1. Please reduce the loads. 2. Please reset the power module redundancy setting. Please refer to 7.10.3 Output Setting.
30	STS Module Fan Abnormal	The STS module's fan components are damaged.	Please contact service personnel for assistance.
31	PFC #n Fan Fault	The fan components of power module #n are damaged.	Please contact service personnel for assistance.
32	Dust Filter Replacement	The filter replacement date is due.	Please contact service personnel for assistance.
33	Parallel Unit Config Incompatible - AC In Type	There are conflicts between the parallel UPS units' AC input settings.	Check if the AC input settings among the parallel UPS units are correct or not, and contact service personnel for assistance.
34	Parallel Unit Config Incompatible - Output Type	There are conflicts between the parallel UPS units' output settings.	Check if the output settings among the parallel UPS units are correct or not, and contact service personnel for assistance.
35	Parallel Unit Config Incompatible - Bat Type	<ol style="list-style-type: none"> 1. There are conflicts between the parallel UPS units' battery settings. 2. The input dry contact settings for the generator is abnormal. 	<ol style="list-style-type: none"> 1. Check if the battery settings among the parallel UPS units are correct or not, and contact service personnel for assistance. 2. Check the input dry contact settings.

No.	Alarm Message	Possible Cause	Solution
36	EXTCAN Comm Loss	The parallel cable is loose or the circuit board is abnormal.	Check if the parallel cable is firmly connected or not, and contact service personnel for assistance.
37	PFC #n Local Comm Loss	The PFC of the power module #n's internal communication cable is loose or the circuit board is abnormal.	Please contact service personnel for assistance.
38	EXTCAN Bus #n Abnormal - Physical	The parallel cable is loose or the circuit board is abnormal.	Check if the parallel cable is firmly connected or not, and contact service personnel for assistance.
39	INTCAN Bus #n Abnormal - Physical	The system's internal communication cable is loose or the circuit board is abnormal.	Please contact service personnel for assistance.
40	MONCAN Bus #n Abnormal - Physical	The system's internal communication cable is loose or the circuit board is abnormal.	Please contact service personnel for assistance.
41	INV #n INTCAN #n Abnormal - Physical	The power module's circuit board has abnormalities.	Please contact service personnel for assistance.
42	Parallel I/O Abnormal	The system's internal communication cable is loose or the circuit board is abnormal.	Please contact service personnel for assistance.
43	INV #n PLL Bus Abnormal	The main AC source's voltage is changed or the power module #n's circuit board is abnormal.	Please confirm if the main AC source's voltage is abnormal or not. If yes, please wait for the main AC source to be restored to normal. If no, please contact service personnel for assistance.
44	CSU Aux Pwr #n Fail	The auxiliary power card #n is abnormal.	Please contact service personnel for assistance.
45	CSU Aux Pwr #n On Repair	The auxiliary power card #n is not inserted.	Please contact service personnel for assistance.
46	Parallel Communication Card #n Removed	The parallel communication card #n is abnormal.	Please contact service personnel for assistance.



No.	Alarm Message	Possible Cause	Solution
47	PM #n Abnormal Absent	The power module #n is abnormally removed or the power outage occurs.	Please contact service personnel for assistance.
48	System Control Card FPGA Config Abnormal	The system control card is abnormal.	Please contact service personnel for assistance.
49	PFC #n Soft Start Fail	The PFC of the power module #n is abnormal.	Please contact service personnel for assistance.
50	INV #n Soft Start Fail	The inverter of the power module #n is abnormal.	Please contact service personnel for assistance.
51	PFC #n Over Heat Warning	The fans of the power module #n are abnormal.	<ol style="list-style-type: none"> 1. Check if any foreign matter blocks the fans or not. If yes, remove the foreign matter. 2. Contact service personnel for assistance.
52	PFC #n Over Heat Shutdown	The fans of the power module #n are abnormal.	<ol style="list-style-type: none"> 1. Check if any foreign matter blocks the fans or not. If yes, remove the foreign matter. 2. Contact service personnel for assistance.
53	PFC #n DC Bus Over Shutdown	The power module #n is abnormal.	Please contact service personnel for assistance.
54	PFC #n DC Bus Under Shutdown	The power module #n is abnormal.	Please contact service personnel for assistance.
55	INV #n Over Heat Warning	The fans of the power module #n are abnormal.	<ol style="list-style-type: none"> 1. Check if any foreign matter blocks the fans or not. If yes, remove the foreign matter. 2. Contact service personnel for assistance.
56	INV #n Over Heat Shutdown	The fans of the power module #n are abnormal.	<ol style="list-style-type: none"> 1. Check if any foreign matter blocks the fans or not. If yes, remove the foreign matter. 2. Contact service personnel for assistance.
57	INV #n DC Bus Over Shutdown	The power module #n is abnormal.	Please contact service personnel for assistance.
58	INV #n DC Bus Under Shutdown	The power module #n is abnormal.	Please contact service personnel for assistance.

No.	Alarm Message	Possible Cause	Solution
59	PFC #n Fuse Open	The PFC of the power module #n is abnormal.	Please contact service personnel for assistance.
60	PM #n Battery Fuse Open	The power module #n is abnormal.	Please contact service personnel for assistance.
61	PM #n Charger Fuse Open	The power module #n is abnormal.	Please contact service personnel for assistance.
62	INV #n Output Fuse Open	The inverter of the power module #n is abnormal.	Please contact service personnel for assistance.
63	PM #n O/P Relay Fault	The power module #n is abnormal.	Please contact service personnel for assistance.
64	PM #n Repair Switch Open	The switch of the power module #n is in the OFF status.	<ol style="list-style-type: none"> 1. Please turn on the switch of the power module #n. 2. If the alarm message still exists after the solution mentioned above has been executed, please contact service personnel.
65	INV #n Over OTP Auto Recover Limit	The inverter of the power module #n activates its own protection mechanism when abnormalities occur and re-starts automatically for more than 3 times.	Please contact service personnel for assistance.
66	INV #n Over DC Bus OVP Auto Recover Limit	The inverter of the power module #n activates its own protection mechanism when abnormalities occur and re-starts automatically for more than 3 times.	Please contact service personnel for assistance.
67	INV #n Over OCP Auto Recover Limit	The inverter of the power module #n activates its own protection mechanism when abnormalities occur and re-starts automatically for more than 3 times.	Please contact service personnel for assistance.
68	INV #n Volt Abnormal	The inverter voltage of the power module #n is abnormal.	Please contact service personnel for assistance.

No.	Alarm Message	Possible Cause	Solution
69	INV #n PWM Carrier Fault	<ol style="list-style-type: none"> The system's internal communication cable is loose. The inverter of the power module #n's circuit board is abnormal. 	Please contact service personnel for assistance.
70	INV PLL Ref Bus Abnormal	<ol style="list-style-type: none"> The system's internal communication cable is loose. The system's circuit board is abnormal. 	Please contact service personnel for assistance.
71	Emergency Pwr Off	The EPO button is pressed.	<ol style="list-style-type: none"> Please confirm if the EPO button is pressed or not. If yes, restart the UPS in accordance with the normal start-up procedures after the relevant abnormalities are eliminated. If the alarm message still exists, please contact service personnel for assistance.
72	On Manual Bypass	The external manual bypass breaker is turned on.	<ol style="list-style-type: none"> Please confirm if the external manual bypass breaker is turned on or not. If yes, restart the UPS in accordance with the normal start-up procedures after the relevant abnormalities are eliminated. If the alarm message still exists, please contact service personnel for assistance.
73	PM #n Charger Volt Abnormal	The charger of the power module #n is abnormal.	Please contact service personnel for assistance.
74	PM #n Charger Current Abnormal	The charger of the power module #n is abnormal.	Please contact service personnel for assistance.
75	CHG #n Over Heat Warning	The fans of the power module #n are abnormal.	<ol style="list-style-type: none"> Check if any foreign matter blocks the fans or not. If yes, remove the foreign matter. Contact service personnel for assistance.

No.	Alarm Message	Possible Cause	Solution
76	CHG #n Over Heat Shutdown	The fans of the power module #n are abnormal.	<ol style="list-style-type: none"> 1. Check if any foreign matter blocks the fans or not. If yes, remove the foreign matter. 2. Contact service personnel for assistance.
77	Ext Parallel Unit Abnormal Absent	The parallel cable has been removed.	Please contact service personnel for assistance.
78	The EMS 1000 ID # Communication Fail	The setting of the EMS 1000 ID # is wrong or the communication cable (CAT-5) of the EMS 1000 ID # is loose or damaged.	Please contact service personnel for assistance.
79	The EMS 1000 ID # Exceeds The Warning Temperature Threshold	<ol style="list-style-type: none"> 1. The environment temperature is too high. 2. The EMS temperature settings are wrong. 	<ol style="list-style-type: none"> 1. Lower the environment temperature. 2. Please contact service personnel for assistance.
80	The EMS 1000 ID # Exceeds The Alarm Temperature Threshold	<ol style="list-style-type: none"> 1. The environment temperature is too high. 2. The EMS temperature settings are wrong. 	<ol style="list-style-type: none"> 1. Lower the environment temperature. 2. Please contact service personnel for assistance.
81	The EMS 1000 ID # Exceeds The Warning Humidity Threshold	<ol style="list-style-type: none"> 1. The environment humidity is too high. 2. The EMS humidity settings are wrong. 	<ol style="list-style-type: none"> 1. Lower the environment humidity. 2. Please contact service personnel for assistance.
82	The EMS 1000 ID # Exceeds The Alarm Humidity Threshold	<ol style="list-style-type: none"> 1. The environment humidity is too high. 2. The EMS humidity settings are wrong. 	<ol style="list-style-type: none"> 1. Lower the environment humidity. 2. Please contact service personnel for assistance.
83	The EMS 1000 ID # Input Contact 1 Triggered	<ol style="list-style-type: none"> 1. The input contact 1 of the EMS 1000 ID # has been triggered. 2. Wrong connection of the device connected to the input contact 1 occurs or the software settings are wrong. 	<ol style="list-style-type: none"> 1. Please check if the connection of the device connected to the input contact 1 of the EMS1000 ID # is abnormal or not. 2. Please contact service personnel for assistance.

No.	Alarm Message	Possible Cause	Solution
84	The EMS 1000 ID # Input Contact 2 Triggered	<ol style="list-style-type: none"> 1. The input contact 2 of the EMS 1000 ID # has been triggered. 2. Wrong connection of the device connected to the input contact 2 occurs or the software settings are wrong. 	<ol style="list-style-type: none"> 1. Please check if the connection of the device connected to the input contact 2 of the EMS1000 ID # is abnormal or not. 2. Please contact service personnel for assistance.
85	The EMS 1000 ID # Input Contact 3 Triggered	<ol style="list-style-type: none"> 1. The input contact 3 of the EMS 1000 ID # has been triggered. 2. Wrong connection of the device connected to the input contact 3 occurs or the software settings are wrong. 	<ol style="list-style-type: none"> 1. Please check if the connection of the device connected to the input contact 3 of the EMS1000 ID # is abnormal or not. 2. Please contact service personnel for assistance.
86	The EMS 1000 ID # Input Contact 4 Triggered	<ol style="list-style-type: none"> 1. The input contact 4 of the EMS 1000 ID # has been triggered. 2. Wrong connection of the device connected to the input contact 4 occurs or the software settings are wrong. 	<ol style="list-style-type: none"> 1. Please check if the connection of the device connected to the input contact 4 of the EMS1000 ID # is abnormal or not. 2. Please contact service personnel for assistance.
87	INV #n MONCAN #n Abnormal - Physical	The power module #n's internal communication cable is loose or the circuit board is abnormal.	Please contact service personnel for assistance.
88	Bypass STS Short Fault	The bypass static switch or its drive circuit is abnormal.	Please contact service personnel for assistance.
89	Online To ECO Transfer Inhibit	In ECO mode, due to the unstable bypass voltage and frequency, the UPS transfers between On-Line mode and ECO mode for too many times within a short period of time.	<ol style="list-style-type: none"> 1. Please check if the bypass voltage and frequency is within the normal range for the UPS to run in ECO mode. 2. If the alarm message still exist after the solution mentioned above has been executed, please contact service personnel.

No.	Alarm Message	Possible Cause	Solution
90	Over Overload Auto Recover Limit	Overload shutdown and auto recovery happen too many times within a short period of time.	<ol style="list-style-type: none"> 1. Please check if the load capacity is beyond the range for the UPS to run normally. 2. If the alarm message still exist after the solution mentioned above has been executed, please contact service personnel.
91	Over INV Volt Abnormal Auto Recover Limit	Abnormal output voltage and auto recovery happen too many times within a short period of time.	<ol style="list-style-type: none"> 1. Please check if there is any abnormality in the loads, e.g. overload or short circuit. 2. If the alarm message still exist after the solution mentioned above has been executed, please contact service personnel.
92	Bypass STS NTC Not Installed	The thermal sensor of the bypass static switch is not properly installed.	Please contact service personnel for assistance.
93	Output Over Current Shutdown	The loads are abnormal or the power modules are damaged.	<ol style="list-style-type: none"> 1. Please check if there is any abnormality in the loads, e.g. overload or short circuit. 2. If the alarm message still exist after the solution mentioned above has been executed, please contact service personnel.
94	Parallel Unit Config Conflict	There are conflicts between the parallel UPS units' parameter settings.	Please contact service personnel for assistance.
95	System Control Card Communication Loss	The system control card is removed or damaged.	<ol style="list-style-type: none"> 1. Please check if the system control card is properly installed. 2. If the alarm message still exist after the solution mentioned above has been executed, please contact service personnel.
96	Bypass STS Module Repair Switch Open	The STS module's switch is not in the upper position ().	<ol style="list-style-type: none"> 1. Turn the STS module's switch to the upper position (). 2. If the alarm message still exist after the solution mentioned above has been executed, please contact service personnel.

No.	Alarm Message	Possible Cause	Solution
97	Bypass STS Module Aux Pwr Fault	The auxiliary power for the STS module malfunctions.	Please contact service personnel for assistance.
98	PFC #n MONCAN Comm Loss	The internal communication of the PFC #n is abnormal.	Please contact service personnel for assistance.
99	INV #n Local Comm Loss	The power module #n's internal communication cable is loose or the circuit board is abnormal.	Please contact service personnel for assistance.
100	INV #n INTCAN Comm Loss	The power module #n's internal communication cable is loose or the circuit board is abnormal.	Please contact service personnel for assistance.
101	INV #n MONCAN Comm Loss	The power module #n's internal communication cable is loose or the circuit board is abnormal.	Please contact service personnel for assistance.
102	PM #n Parallel I/O Fault	The parallel I/O communication cable of the power module #n is loose or the circuit board is abnormal.	Please contact service personnel for assistance.
103	INV #n DC Offset Fault Warning	The inverter of the power module #n is abnormal.	Please contact service personnel for assistance.
104	INV #n Over OutRelayVDP Auto Recover Limit	The bypass voltage waveform is abnormal, or the inverter voltage of the power module #n is abnormal, resulting in a repeated alarm.	<ol style="list-style-type: none"> 1. Please check if the bypass voltage waveform is normal. 2. If the alarm message still exist after the solution mentioned above has been executed, please contact service personnel.
105*2	INV #n Output Relay VoltDiff Abnormal - R	The bypass voltage waveform is abnormal, or the inverter voltage of the power module #n is abnormal.	<ol style="list-style-type: none"> 1. Please check if the bypass voltage waveform is normal. 2. If the alarm message still exist after the solution mentioned above has been executed, please contact service personnel.
106*2	INV #n Output Relay VoltDiff Abnormal - S	The bypass voltage waveform is abnormal, or the inverter voltage of the power module #n is abnormal.	<ol style="list-style-type: none"> 1. Please check if the bypass voltage waveform is normal. 2. If the alarm message still exist after the solution mentioned above has been executed, please contact service personnel.

No.	Alarm Message	Possible Cause	Solution
107*2	INV #n Output Relay VoltDiff Abnormal - T	The bypass voltage waveform is abnormal, or the inverter voltage of the power module #n is abnormal.	<ol style="list-style-type: none"> 1. Please check if the bypass voltage waveform is normal. 2. If the alarm message still exist after the solution mentioned above has been executed, please contact service personnel.
108	Battery Fuse Open	<ol style="list-style-type: none"> 1. The UPS's battery fuses are damaged. 2. The battery module's fuse is damaged. 	<ol style="list-style-type: none"> 1. Check the UPS's battery fuses or the battery module's fuse. 2. Check if the settings of input dry contacts are correct. 3. Please contact service personnel for assistance.
109	Battery Abnormal Shutdown	Due to battery abnormalities, the UPS shuts down when it transfers to run in battery mode.	<ol style="list-style-type: none"> 1. Check the BMS warning message. 2. Check if the settings of input dry contacts are correct. 3. Please contact service personnel for assistance.
110	Battery Abnormal Warning	The BMS warning message shows that the batteries are abnormal.	<ol style="list-style-type: none"> 1. Check the BMS warning message. 2. Check if the settings of input dry contacts are correct. 3. Please contact service personnel for assistance.
111	INV #N Current Sensing Abnormal	The power module #n is abnormal.	Please contact service personnel for assistance.

**NOTE:**

1. If the alarm still exists after the above possible causes are eliminated, please contact your dealer or customer service.
2. *2 The phase R/ S/ T shown in the alarm messages (No. 105 ~ 107) represents the phase L1/ L2/ L3 respectively.

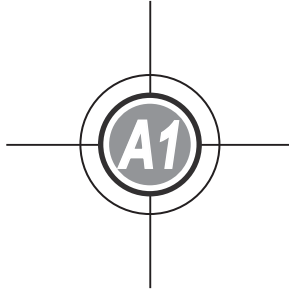

Technical Specifications

Model		DPH						
UPS Capacity		15kVA/ 15kW	30kVA/ 30kW	45kVA/ 45kW	60kVA/ 60kW	75kVA/ 75kW	90kVA/ 90kW	105kVA/ 105kW
Input	Nominal Voltage	120/208 Vac, 127/220 Vac (3Φ4W + G)						
	Voltage Range	96 ~ 146 Vac/166 ~ 253 Vac (full load)						
	Current Harmonic Distortion	≤ 3%* ¹						
	Power Factor	> 0.99						
	Frequency Range	40 ~ 70 Hz						
Output	Voltage	120/208 Vac, 127/220 Vac (3Φ4W + G)						
	Voltage Harmonic Distortion	≤ 2% (linear load)						
	Power Factor	1						
	Frequency	50/60 Hz						
	Overload Capability	≤ 125%: 10 minutes; ≤ 150%: 1 minute; > 150%: 1 second						
Display		10" Touch Panel						
Interface	Standard	External battery temperature dry contact × 4, External switch/breaker status dry contact × 4, Output dry contact × 6, Input dry contact × 4, Parallel port × 4, USB type A × 2, USB type B × 1, RS-232 port × 1, MODBUS port × 1, BMS (RJ45) × 1, Ethernet × 1, SMART slot × 1, REPO × 1						
Efficiency	Online Mode	up to 95%						
	ECO Mode	up to 98.5%						
Battery	Nominal Voltage	± 168 Vdc						
	Charge Voltage	± 190 Vdc (adjustable from 182 Vdc to 196 Vdc)						

Model		DPH						
UPS Capacity		15kVA/ 15kW	30kVA/ 30kW	45kVA/ 45kW	60kVA/ 60kW	75kVA/ 75kW	90kVA/ 90kW	105kVA/ 105kW
Battery	Protection of Battery Deep Discharge	Yes						
Environment	Operating Altitude	3300 ft (1000 meters) (without derating)						
	Operating Temperature	32 ~ 104°F (0 ~ 40°C)						
	Relative Humidity	< 95% (non-condensing)						
	Audible Noise	≤ 68 dBA ^{*2}						
	IP Degree of Protection	IP 20						
Others	Parallel Redundancy	Yes						
	Emergency Power Off	Yes (remote: default; local: optional)						
	Battery-start	Yes						
Physical	Dimensions (W x D x H)	23.62" x 33.46" x 78.74" (600 x 850 x 2000 mm)						
	Weight	UPS Frame (without power modules): 619.5 lb (281 kg)						
		Power Module (optional) : 46.3 lb (21 kg)/ 1 PC						



NOTE:

- *1: When input vTHD is <1%.
- *2: At a distance of 3.3 ft (1 meter) in front of the UPS under full load condition.
- Please refer to the rating label for the safety rating.
- All specifications are subject to change without prior notice.

The logo consists of a central circle containing the text 'A2'. This circle is surrounded by a larger, fainter circle. Four thin lines extend from the center of the circles towards the top, bottom, left, and right edges of the page.

Warranty

Seller warrants this product, if used in accordance with all applicable instructions, to be free from original defects in material and workmanship within the warranty period. If the product has any failure problem within the warranty period, Seller will repair or replace the product at its sole discretion according to the failure situation.

This warranty does not apply to normal wear or to damage resulting from improper installation, operation, usage, maintenance or irresistible force (i.e. war, fire, natural disaster, etc.), and this warranty also expressly excludes all incidental and consequential damages.

Maintenance service for a fee is provided for any damage out of the warranty period. If any maintenance is required, please directly contact the supplier or Seller.



WARNING:

The individual user should take care to determine prior to use whether the environment and the load characteristic are suitable, adequate or safe for the installation and the usage of this product. The User Manual must be carefully followed. Seller makes no representation or warranty as to the suitability or fitness of this product for any specific application.

No. 501327880001
Version : V 0.1
Release Date : 2020_5_5

- Global Headquarter

Taiwan

Delta Electronics Inc.
39 Section 2, Huandong Road, Shanhua District,
Tainan City 74144, Taiwan
T +886 6 505 6565
E ups.taiwan@deltaww.com

- Regional Office

The United States

Delta Electronics (Americas) Ltd.
46101 Fremont Blvd. Fremont, CA 94538
T +1 510 344 2157
E ups.na@deltaww.com

Australia

Delta Energy Systems Australia Pty Ltd.
Unit 20-21, 45 Normanby Road, Notting Hill VIC 3168, Australia
T +61 3 9543 3720
E ups.australia@deltaww.com

South America

Delta Greentech (Brasil) S/A
Rua Itapeva, 26 - 3º andar Edifício Itapeva One - Bela Vista
01332-000 - São Paulo - SP - Brazil
T +55 11 3568 3850
E ups.brazil@deltaww.com

Thailand

Delta Electronics (Thailand) Public Co.,Ltd.
909 Soi 9, Moo 4, E.P.Z., Bangpoo Industrial Estate, Tambon Prakasa,
Amphur Muang-samutprakarn, Samutprakarn Province 10280, Thailand
T +662 709-2800
E ups.thailand@deltaww.com

China

Delta GreenTech (China) Co., Ltd.
238 Minxia Road, Pudong, Shanghai, 201209 P.R.C
T +86 21 5863 5678
+86 21 5863 9595
E ups.china@deltaww.com

South Korea

Delta Electronics (Korea), Inc.
1511, Byucksan Digital Valley 6-cha, Gasan-dong, Geumcheon-gu,
Seoul, Korea, 153-704
T +82-2-515-5303
E ups.south.korea@deltaww.com

Singapore

Delta Electronics Int'l (Singapore) Pte Ltd.
4 Kaki Bukit Ave 1, #05-04, Singapore 417939
T +65 6747 5155
E ups.singapore@deltaww.com

India

Delta Power Solutions (India) Pvt. Ltd.
Plot No. 43, Sector-35, HSIIDC, Gurgaon-122001, Haryana, India
T +91 124 4874 900
E ups.india@deltaww.com

EMEA

Delta Electronics (Netherlands) BV
Zandsteen 15, 2132MZ Hoofddorp, The Netherlands
T +31 20 655 09 00
E ups.netherlands@deltaww.com

